

Respironics V200 Ventilator

Operator's Manual

PHILIPS



For Technical Support and Customer Service, contact:

USA and Canada: 1-800-345-6443 or 724-387-4000
Respironics Europe, Africa, Middle East: +33-1-47-52-30-00
Respironics Asia Pacific: +852-3194-2280
Facsimile: 724-387-5012

USA

Respironics California, Inc.
2271 Cosmos Court
Carlsbad, CA 92011

Email and web addresses

service@philips.com
clinical@philips.com
www.philips.com\healthcare

Authorized European address

Respironics Deutschland GmbH
Gewerbestrasse 17
D-82211 Herrsching
Germany
+49-8-15-29-30-60



© 2009 Respironics and its affiliates.
All rights reserved.

This work is protected under Title 17 of the United States copyright code and is the sole property of Respironics. No part of this document may be copied or otherwise reproduced, or stored in any electronic information retrieval system, except as specifically permitted under United States copyright law, without the prior written consent of Respironics.

Table of Contents

1.	Introduction and Intended Use	1-1
2.	Warnings, Cautions, and Notes	2-1
	Summary of Warnings, Cautions, and Notes	2-1
3.	Symbols	3-1
4.	Getting Started	4-1
	Unpacking	4-1
	Inspection	4-2
	List of Parts and Accessories	4-2
	Repacking	4-3
	Ventilator Positioning	4-4
	Backup Battery	4-4
	Inspiratory Bacteria Filter Installation	4-16
	Heated Expiratory Bacteria Filter Installation	4-18
	Oxygen Source Connection	4-20
	Patient Circuit Flex Arm Installation	4-22
5.	Setup	5-1
	Back Panel Connections and Controls	5-1
	Connecting AC Power Cord	5-3
	Power On/Off	5-4
	Entering Diagnostic Mode	5-5
	User Configuration Screen	5-7
	Backup Battery	5-11
	Extended Self Test (EST)	5-12
6.	Connecting Additional Equipment	6-1
	Communication Interface	6-1
	Connecting Serial Communications Devices	6-2
	Connecting Remote Alarm Port	6-2
	Connecting Humidifier	6-3
	Connecting the Patient Circuit	6-5
	Connecting the Analog Port	6-7
7.	Operating Theory	7-1
	Introduction	7-1
	System Overview	7-1
	Ventilator Breath Types	7-1
	Ventilation Modes Common to VCV and PCV	7-3
	Ventilation Modes Common to NPPV	7-6
	Emergency Modes of Ventilation	7-7

Contents

8.	Operating Instructions	8-1
	Overview	8-1
	The Front Panel	8-3
	Ventilator Screens	8-11
	Settings Screens	8-14
	Selecting a New Ventilation Breath Type (VCV, PCV, or NPPV)	8-23
	Selecting the Mode (A/C-SIMV-CPAP or Spont-Spont/T)	8-26
	Apnea Ventilation	8-27
	Patient Data Screen	8-28
	Monitor Screen	8-29
	Special Procedures	8-31
	Preoperational Procedure	8-32
	Alarm Testing Procedure	8-34
	Where To Go For Help	8-34
9.	Alarms	9-1
	Introduction	9-1
	Visual Alarms	9-1
	Audible Alarms	9-2
	Alarm Reset	9-3
	Alert Messages	9-4
	Alarm Indicators	9-9
10.	Care and Maintenance	10-1
	General Information	10-1
	Cleaning	10-1
	Sterilization	10-2
	Bacteria Filters	10-4
	Periodic Maintenance	10-7
	Storage	10-10
	Repairs	10-10
11.	Diagnostics	11-1
	Entering Diagnostic Mode	11-2
	Diagnostic Functions	11-3
	Extended Self Test (EST)	11-4
	Self Test	11-10
12.	Technical Specifications	12-1
	Breath Types	12-1
	Modes	12-1
	Volume Ventilation Settings, Ranges and Resolution	12-1
	Pressure Control Ventilation Settings, Ranges and Resolution	12-2
	Non-Invasive Positive Pressure Ventilation Settings, Ranges and Resolution	12-3
	Apnea Ventilation	12-3
	Value Entry Message	12-4

Patient Data Screen	12-5
Front Panel Keys	12-6
Level Controls	12-7
Calculated Values from Expiratory Hold Maneuver	12-7
Interface Ports	12-7
Environmental Specifications	12-8
Environmental Protection	12-8
Alarms	12-8
Connectors	12-9
Filters	12-10
Measuring and Display Devices	12-10
AC Power and Battery Indicators	12-10
Leakage Current	12-11
Compliance and Approvals	12-11
Power Requirements	12-11
Dimensions and Weights	12-12
Electromagnetic Compatibility Declaration	12-12
Pneumatic System	12-17
Labels	12-18
13. Options and Accessories	13-1
Introduction	13-1
Oxygen Sensor Option	13-3
Assemble O ₂ Sensor	13-3
Attaching the Sensor to the Ventilator	13-4
Warranty	13-5
O ₂ Sensor Tee	13-5
External Battery Option	13-7
Installation	13-8
Power Consumption Sequence	13-8
External Battery/Backup Battery Operation	13-8
Battery Capacity	13-10
Battery Charging	13-10
Testing	13-11
Battery Specifications	13-11
Warranty	13-12
Oxygen Manifold Option	13-13
Kit Contents	13-13
Assembly Instructions	13-14
Replacement Parts:	13-17
Using the Manifold	13-17

Contents

Graphics	13-19
Starting Graphics	13-19
Using Graphics	13-19
Replotting and Scrolling	13-20
Rescaling the Display	13-20
Freeze Feature	13-22
Save and Overlay Features	13-23
Inspiratory Area	13-24
Alarms During Graphics	13-25
Communications Option (Com1)	13-27
Print Screen	13-27
VueLink Compatibility	13-29
Configuring the VueLink Module	13-30
Analog Output (Chart Recorder)	13-36
RS-232 Communications Option 2 (Com2)	13-39
RS-232 Configuration	13-39
Commands Transmitted to the Ventilator	13-40
Transmission of Data from the Ventilator	13-40
SNDA<CR>, Send Variable Length Ventilator Settings Report	13-40
Respiratory Mechanics Option	13-51
Accessing Respiratory Mechanics Data	13-51
Vital Capacity Maneuver	13-52
MIP/PO.1 Maneuver	13-54
Static C and R Maneuver	13-56
Alarms and Error Messages	13-58
Compliance (C) and Resistance (R) Computations	13-65
Trending Option	13-69
Accessing Trending Data	13-69
Selecting Parameters for Display	13-72
Using the Manual Rescale Function	13-74
Changing the Cursor Position	13-74
Selecting the Time Scale	13-75
Using the +2 Hrs/-2 Hrs buttons	13-76
Using the Zoom Function	13-76
Using the Rescale Button	13-76
Using the View 1/View 2 buttons	13-77
Using the Clear button	13-77
Alarms during Trending	13-77
PCMCIA Card	13-77
Trending Not Available	13-78
Specifications	13-78

Flow-Trak® Option	13-83
On the Screen	13-84
Breath Delivery	13-85
Inspiratory Hold	13-85
Respiratory Mechanics	13-85
Alarms	13-86
Respiratory Profile Monitor Interface (NICO-Esprit) Option	13-87
System Requirements	13-87
Hardware Setup	13-88
RS-232 Communications	13-91
Trended NICO Data	13-92
Troubleshooting	13-96
Neonatal Option	13-97
System Requirements	13-97
Changing Patient Types	13-98
Percent Leak	13-101
Patient Leak Values	13-102
Speaking Mode Option	13-103
Warnings, Cautions, and Notes	13-103
Patient Preparation	13-104
Settings	13-106
Starting Speaking Mode	13-106
Alarms	13-109
Displayed Data	13-111
Trended Data	13-112
Discontinue Speaking Mode	13-115
Auto-Trak Sensitivity™	13-117
Introduction	13-117
Compatible Patient Interfaces	13-117
How to Select Auto-Trak	13-118
Turning Auto-Trak Off	13-121
Triggering and Cycling with Auto-Trak	13-121
Leak Detection and Compensation	13-121

Contents

A.	RS-232 Communications Protocol	A-1
	RS-232 Configuration	A-1
	Commands Transmitted to the Ventilator	A-1
	Transmission of Data from the Ventilator	A-1
	Ventilator Report Command and Response (VRPT)	A-1
	Volume Control Ventilation Settings Report (VCVS)	A-11
	Pressure Control Ventilation Settings Report (PCVS)	A-14
	Non-Invasive Positive Pressure Ventilation Settings Report (NPVS)	A-16
	Patient Data Report (PTDT)	A-18
	Alarm Status Report (ALRM)	A-21
	Unrecognized Commands	A-24
B.	Customer Service & Warranty	B-1
	Customer Service	B-1
	Warranty	B-1
	Options and Accessories	B-2
C.	Alarm Testing Procedure	C-1
	Glossary	Glossary-1
	Index	Index-1

Chapter 1. Introduction and Intended Use

The Respirationics V200 Ventilator is a microprocessor-controlled, electrically powered mechanical ventilator. It is intended for use by qualified medical personnel to provide continuous or intermittent ventilatory support for adult, pediatric, and neonatal patients as prescribed by a physician. The ventilator is intended for use in either invasive or non-invasive applications in institutional environments.

The Respirationics V200 Ventilator meets applicable safety requirements, consensus guidelines, U.S.A. regulatory statutes, and international regulatory standards for life support/mechanical ventilation devices.

Please read this manual thoroughly and become familiar with the ventilator's operation before using it on a patient. For additional information about accessories or related equipment, such as humidifiers and remote alarm systems, refer to the appropriate instruction manual prior to operating the accessory with the ventilator.

Advanced troubleshooting, calibration, and maintenance instructions are included in the Esprit /V200 Ventilator Service Manual, P/N 580-1000-02. All maintenance and repair work should be performed by qualified biomedical technicians who have received appropriate training and authorization to provide maintenance, repair, and service for the ventilator.

WARNING: Patients on life-support equipment should be visually monitored by competent medical personnel, since life-threatening circumstances may arise that may not activate alarms. Heed all appropriate alarms and follow the instructions and warnings in this operator's manual. Always check life-support equipment for proper operation before use.

WARNING: Do not use in the presence of flammable anesthetics. Possible explosion hazard.

CAUTION: Federal law (USA) restricts this device to sale by or on the order of a physician.

NOTE: Follow the setup instructions in this manual before placing the Respirationics V200 Ventilator into service. If you have questions, contact Respirationics Customer Service at 1-800-345-644

(This page is intentionally blank.)

Chapter 2. Warnings, Cautions, and Notes

Throughout this manual the following definitions apply:

WARNING: A condition that could cause injury to a patient or operator if the operating instructions in this manual are not followed correctly.

CAUTION: A condition that could cause damage to, or shorten the service life of, the Respironics V200 Ventilator.

NOTE: Important information concerning the construction or operation of the Respironics V200 Ventilator.

Additional Warnings, Cautions, and Notes pertaining to options and accessories are included in the documentation for each option or accessory. Refer to Chapter 13, "Options and Accessories" .

Summary of Warnings, Cautions, and Notes

Warnings

- Patients on life-support equipment should be visually monitored by competent medical personnel, since life-threatening circumstances may arise that may not activate alarms. Heed all appropriate alarms and follow the instructions and warnings in this operator's manual. Always check life-support equipment for proper operation before use.
- Do not use in the presence of flammable anesthetics. Possible explosion hazard.
- One person alone should not attempt to lift the ventilator or remove it from the shipping carton or the cart. At least two people are required to avoid possible personal injury or damage to the equipment.
- To reduce the chance of contamination or infection, always use an inspiratory and expiratory filter when the ventilator is in operation. Refer to manufacturer's instructions and follow institutional infection control guidelines when replacing the inspiratory and expiratory filter.
- Do not use anti-static or conductive hoses or conductive patient tubing.
- The expiratory filter housing may be hot if removed from the ventilator immediately after use. Wait 15 minutes after turning off

Warnings, Cautions, and Notes

ventilator power before removing the heated expiratory bacteria filter. Exercise caution when handling the filter housing.

- All oxygen connections should be carefully inspected to ensure that leaks are not present. Excessive leaks can result in higher than normal ambient oxygen concentrations and create a potentially hazardous oxygen-enriched environment.
- Worn/frayed oxygen hoses or oxygen hoses contaminated by hydrocarbon greases or oils should not be used since an oxygen leak or intense fire could result.
- Care in the routing of the oxygen inlet hose should be exercised to ensure it is not exposed to mechanisms that could cause damage by cutting or heating/melting.
- The cover plate for the PCMCIA slot at the back of the ventilator must be replaced after the adapter and card are installed. This is to protect the ventilator.
- AC power is applied to the humidifier from the ventilator humidifier outlet (only available on 100-120 VAC ventilators). Under no circumstances does the Respironics V200 Ventilator provide control for the humidifier. To ensure patient safety, it is important that any humidifier used with the ventilator include an acceptable temperature control and monitoring mechanism, as well as a temperature display and appropriate alarm capabilities (refer to ISO 8185).
- To avoid electrical shock hazard, connect the ventilator to a properly grounded AC power outlet.
- The ventilator front panel LEDs will indicate the power source that is being used. If the ventilator is plugged in and the MAINS LED is not lit, either the circuit breaker is off or the wall power outlet is not functioning.
- The two circuit breakers (MAINS/Humidifier) located on the back of the ventilator are covered to prevent unintentional ventilator power-off. Do not use the circuit breaker to power the ventilator on/off. The power switch is located on the front of the ventilator below the front panel.
- Always turn the ventilator power OFF before connecting additional equipment.
- Use only Respironics approved cables when connecting to the remote alarm port. Be sure to fully insert the cable into the remote alarm port and into the remote alarm.

Warnings, Cautions, and Notes

- When using the Remote Alarm Port be sure to fully test the Remote Alarm Port and cable by:
 - Verifying that annunciated alarms on the ventilator are also annunciated on the remote alarm.
 - Verifying that disconnecting the cable from the Remote Alarm port results in an alarm notification at the Remote Alarm.
 - Verifying that disconnecting the cable from the remote alarm results in an alarm notification at the Remote Alarm.
- Ensure that an alternative means of ventilation (that is, a resuscitator or similar device) is available while the ventilator is in use on a patient.
- The ventilator complies with the requirements of IEC 601-1-2 (EMC collateral standard), including the E-field susceptibility requirements at a level of 10 volts per meter. However, even at this level of immunity, certain transmitting devices (cellular phones, walkie-talkies, etc.) emit radio frequencies that could disrupt ventilator operation if operated in a range too close to the ventilator.
- DO NOT operate the ventilator in a Magnetic Resonance Imaging (MRI) environment.
- Vent Inop is a serious condition, which is indicated by both visual and audible alarms. If the ventilator is attached to a patient when Vent Inop occurs, the patient must be supported with another means of life support ventilation.
- When the battery low indicator is flashing red, operation of the ventilator from battery power should be discontinued.
- For patient safety the HIP Limit Setting should be set as close to the peak inspiratory pressure as patient conditions allow.
- DO NOT perform the preoperational procedure when the ventilator is on a patient.
- You will be warned if the compliance is 9.0 ml/cmH₂O (hPa) or larger. Patients should not be put on a patient circuit that does not meet this requirement.
- A high priority, visual and audible alarm indicates a potentially life-threatening condition and immediate response is required.
- When the safety valve open indicator is lit, the ventilator does not provide any ventilatory support to the patient. Immediately use a backup means of ventilatory support.
- Visually monitor the patient and ventilator during the Alarm Silence period to ensure that alarms do not go undetected. Allowing alarm conditions to continue without intervention may result in harm to the patient and/or ventilator.
- Do not expose expiratory and inspiratory bacteria filters or reusable patient tubing to ETO gas.

Warnings, Cautions, and Notes

- Disposable or single-patient filters must be discarded between patients. Do not chemically disinfect or expose single patient use bacteria filters to ETO gas.
- The patient must be disconnected from the ventilator before entering the Diagnostic Mode since normal ventilation is suspended.
- Do not use a ventilator that has failed SST without verifying operational readiness by other means. Doing so may place a patient at risk.
- Never initiate SST while the patient is connected to the ventilator. The high airway pressures generated during SST can injure a patient.
- Never initiate EST while the patient is connected to the ventilator. The high airway pressures and gas flows generated during EST can injure a patient.
- Do not use a ventilator that has failed EST without verifying operational readiness by other means. Doing so may place a patient at risk.
- Remove the ventilator from service and contact trained service personnel if any diagnostic codes appear with the exception of: 1, 3, 2000, 3000, 5000, 5002, 8003, or 8004.
- Use of a ventilator that has not passed SST or EST is against the strongest recommendation of Respironics.
- Please contact Respironics Customer Service at 1-800-345-6443 or consult your service manual if any diagnostic codes are encountered.
- When connecting a humidifier to the humidifier outlet (available only on 100-120 VAC ventilators) allowable leakage current values may be exceeded.
- The use of accessories, cables, and transducers other than those specified may result in increased EM emissions or decreased immunity of the system.
- We recommend that you use an oxygen monitor that complies with ISO-7767; Oxygen Monitors or Monitoring Patient Breathing Mixtures - Safety Requirements. This requirement ensures that the desired fraction of inspired oxygen (FiO₂) is delivered to the patient.
- The batteries (backup battery) in the battery compartment are non-spillable sealed lead acid. Recycle or dispose of batteries properly.
- Do not connect the DC power cord from the backup battery while the Respironics V200 is functioning as a ventilator. Always turn the Power On/Off switch to off (⏻).

Warnings, Cautions, and Notes

- Backup battery operating life may be affected by battery age and the number of times it has been discharged and recharged. Over time the battery will degenerate and will not provide the same amount of operating time per charge that is available from a fully charged new battery. Use only the Respironics backup battery P/ N 1059956.
- Titrate the EPAP level such that the masks air entrainment valve (if present) remains closed to room air. Always evaluate and monitor patient condition when adjusting EPAP or other settings.
- The backlight lamps in the monitor display contain mercury, which must be recycled or disposed of in accordance with local, state, or federal laws. (Within this system, the backlight lamps in the monitor display contain mercury.)

Cautions

- Federal law (USA) restricts this device to sale by or on the order of a physician.
- Be sure to check all exterior parts of the ventilator. Problems found during inspection should be corrected and/or reported to Respironics before using the ventilator.
- Always ship the ventilator using the original packing material. If the original material is not available, contact your Respironics representative to order replacements.
- Do not operate the ventilator without a properly functioning expiratory filter and heater. Doing so may cause damage to delicate ventilator components, such as the expiratory flow sensor, which may lead to inaccurate spirometry or a Vent Inop condition.
- The ventilator oxygen filter should be replaced annually as a part of preventive maintenance.
- The PCMCIA card should only be removed by trained service personnel once power to the ventilator is off.
- To avoid the possibility of damage to the ventilator, do not connect a humidifier whose maximum rating exceeds 3 amps. Ensure that the humidifier power cord is free from defects and any obvious wear, and is properly grounded. A humidifier connection is only available on 100-120VAC ventilators.
- Before connecting the ventilator to the AC power source, ensure that the total electrical load does not exceed the ampere rating of the AC branch circuit, especially when using the ventilator with other electrical equipment. An AC branch circuit includes all outlets serviced by a single circuit breaker. If the maximum current drain through a branch circuit exceeds the circuit breaker's rating, the branch circuit will open, causing the

ventilator to lose power. For further information, consult a service technician or a trained biomedical technician.

- The ventilator is shipped with a power cord that complies with electrical safety standards. Do not use substitute power cords unless specifically instructed to do so by an authorized distributor or qualified personnel. Do not modify the power cord or connect it with electrical extension cords or outlet adapters.
- To prevent the risk of excessive leakage due to external equipment being connected to the ventilator via the communication ports, a means for external separation of the conductive earth paths must be provided.
- All equipment used and connected to the ventilator communications ports (analog, parallel, and serial) must comply with the medical electrical equipment (IEC601-1) or other applicable standards.
- The remote alarm port is intended to connect only to SELV (safety extra low voltage and ungrounded system with basic insulation to ground), in accordance with IEC60601-1. To prevent damage to the remote alarm, the signal input should not exceed the maximum rating of 24 VAC or 36 VDC at 500 mA with a minimum current of 1 mA.
- Failure to protect the expiratory filter from damage by using inappropriate patient circuit configurations may cause damage to delicate ventilator components, such as the expiratory flow sensor, which may lead to inaccurate spirometry or a Vent Inop condition.
- If clinical conditions do not require setting the HIP Limit above 60 cmH₂O, we recommend the setting normally be adjusted to 60 cmH₂O or less in order to prolong the operating life of the blower and to maximize backup battery run time.
- The ventilator alarm indicators and the Alerts insert should be monitored closely during the Alarm Silence period to ensure that unexpected alarms are noticed.
- If an alarm persists for no apparent reason, contact Respirationics Customer Service at 1-800-345-6443.
- Care should be taken when cleaning the touch display. (Refer to Figure 8-2 on page page 8-3). A soft moist cloth should be used that does not drip water and/or soap solution when in contact with the display. After cleaning and rinsing with a damp cloth, remove all moisture with a dry, soft cloth. Never allow solutions of any kind to collect on the bottom bezel of the display. Never use a brush or device that can cause abrasion to clean the touch display or its bezel; they will cause irreparable damage.
- Do not remove any screws from the cooling filter area. Removing screws from this area will result in damage to internal components.

Warnings, Cautions, and Notes

- Follow the detergent manufacturer's instructions. Exposure to detergent solution stronger than necessary can shorten the useful life of the product. Rinse parts thoroughly to remove all detergent residues. Wipe parts dry. Detergent residue can cause blemishes or fine cracks, especially on parts exposed to elevated temperatures during sterilization.
- Autoclavable parts will withstand repeated steam autoclaving at temperatures not to exceed 135° C (275°F).
- DO NOT autoclave the ventilator.
- Formaldehyde, phenol-based, and quaternary ammonium compound (QUATS) disinfectants are not recommended because these agents can cause cracking and crazing of plastic parts. Exposure of components to disinfectant concentrations stronger than required or for excessive time may shorten product life. Parts should be thoroughly rinsed and dried to prevent spotting and blemishes when exposed to elevated temperatures.
- DO NOT allow liquid to penetrate the ventilator rear or front panel. DO NOT attempt to sterilize the ventilator by exposing to ETO gas. DO NOT steam-autoclave.
- Troubleshooting and repair should be performed only by a qualified service technician.
- If the optional external O₂ sensor is in-line, it must be calibrated during EST.
- Diagnostic codes should only be cleared by qualified personnel.
- To prevent contamination of the O₂ sensor, always locate it between the ventilator gas output port and the inspiratory bacteria filter.
- PVC O₂ (P/N 8-100498-00) and Ultem® (P/N 1020380) Sensor Tees cannot be autoclaved or chemically disinfected.
- When inserting the battery tray into the cart's center column, make sure not to crimp cable connections between the battery tray and cart.
- The backup battery is designed to be charged only by the Respirationics V200 Ventilator. Under no circumstances should an attempt be made to charge it in any other way.
- If the ventilator will not be used for 30 days or more, the backup battery should be preserved. Either disconnect the backup battery from the ventilator or keep the ventilator plugged into an active electrical outlet.

Notes

- Follow the setup instructions in this manual before placing the Respirationics V200 Ventilator into service. If you have questions, contact Respirationics Customer Service at 1-800-345-644
- Save the shipping container in case the backup battery has to be returned to Respirationics.
- We recommend that before using the ventilator for the first time, wipe the exterior clean and disinfect or sterilize its components according to the instructions in Chapter 10, "Care and Maintenance" or the component manufacturer's instructions.
- Follow institutional infection control guidelines when replacing the inspiratory or expiratory bacteria filter.
- When adding attachments or other components or subassemblies to the breathing system, for example, an HME or humidifier, ensure that the inspiratory and expiratory resistances (measured at the patient connection port) do not exceed 6 cmH₂O (hPa) at a flow of 60 L/min for adults, 30L/min for pediatrics.
- High humidity and aerosol medications may reduce expiratory filter life, increase expiratory resistance, and/or cause filter damage. Review ventilator patient graphics frequently for changes in expiratory resistance. Consult filter manufacturer recommendations regarding duration of use, maintenance, and removal and disposal of expiratory filter.
- The ventilator should only be connected to an appropriate medical grade 100% O₂ gas source capable of delivering a regulated 40 to 90 PSIG (276-620 kPa).
- The ventilator is shipped with the appropriate gas fittings and hoses for the intended environment, i.e. DISS (U.S.A. and Canada), Ohmeda (Germany), NIST (UK), Air Liquide (France), SIS (Australia).
- All volumes entered into the ventilator are assumed to be BTPS (Body Temperature atmospheric Pressure Saturated (with H₂O)) volumes unless otherwise noted. All volumes reported by the ventilator are reported as BTPS volumes. All pressures are assumed to be relative to atmospheric pressure unless otherwise noted.
- The Air Inlet Filter houses a reusable foam filter that should be periodically cleaned. Refer to Chapter 10, "Care and Maintenance", for more information on filter changes.
- Unless the Mains Circuit Breaker is turned OFF, electrical power is applied to the ventilator even though the front panel switch is in the OFF position. With the Mains Circuit Breaker ON, if the backup battery is connected, the ventilator will charge the battery if it requires a charge.

Warnings, Cautions, and Notes

- To disconnect the ventilator from MAINS power, remove the AC plug from the wall power receptacle. The MAIN switch/circuit breaker is covered to prevent unintentional ventilator turn off.
- If the operator sets the %O₂ setting to 100%, the 100% O₂ indicator does not light. The 100% O₂ indicator only lights when the 100% O₂ front panel key has been pressed.
- The ventilator selects its power source based on the following prioritization: AC power (if present), external battery, then backup battery.
- The ventilator may automatically reset certain types of alarm conditions once the causes of the alarms are corrected. After an automatic reset, the ventilator will clear the audible alarm and will display a Low Urgency Alarm alert in the Alert Message Insert to inform the operator that an alarm condition existed. When this situation occurs, use ALARM RESET to clear the visual alarm indicator.
- For optimal performance and battery life of a newly purchased backup battery, establish full backup battery charge by plugging the ventilator into AC power for eight (8) hours maximum, or until the charging indicator light turns off, and then unplug the unit.
- To monitor backup battery performance and life, run the ventilator on battery power for at least 20 minutes at typical settings once a month. Recharge the battery when the test is complete.
- If the 100% O₂ key is pressed and a 100% O₂ gas source is not available, the Low O₂ alarm will be active for the two-minute 100% O₂ delivery period.
- Manual breaths are not permitted during the inspiratory phase of a breath (whether manual or spontaneous). Pressing the MANUAL BREATH key during these times will not result in the delivery of a manual breath.
- Some settings buttons appear active despite the fact they are not being used in the ACTIVE MODE. This is because the setting is used in Apnea Ventilation or when manual inspiration is pressed. The operator should always choose a value for an active button that is appropriate for the patient being ventilated.
- When the active mode is set to NPPV, the HIP Limit Setting will automatically be adjusted to 10 cmH₂O above the current IPAP setting.
- Pt. Leak only appears on Patient Data block on Settings screen.
- The V200 Ventilator keeps a distinct set of alarm limits for each ventilation breath type (VCV, PCV and NPPV).
- Any of the changes made in the screen shown in Figure 8-18, do not take effect until the operator switches to the new ventilation breath type (in this case Pressure Control).

Warnings, Cautions, and Notes

- If the EXP HOLD key is held continuously, and the expiratory hold maneuver exceeds 5 seconds, the ventilator automatically terminates the expiratory hold maneuver and begins a new inspiratory period.
- If Auto PEEP as calculated in Equation 1: $\text{Auto-PEEP} = \text{Expiratory Pause Pressure} - \text{End Expiratory Pressure}$, is negative, Auto-PEEP will be displayed as “—.”
- All components of the patient circuit must not have leaks in order to pass SST.
- If time is found to be incorrect more than once in the preoperational procedure, an internal battery may have to be replaced. Contact qualified service personnel or call Respironics Customer Service at 1-800-345-6443.
- Because conditions and practices in health care institutions vary, this manual can only describe general guidelines. It is the user's responsibility to ensure the validity and effectiveness of the methods used.
- Because some environments cause a quicker collection of lint and dust than others, inspect and clean the fan filters more often than every 250 hours if necessary.
- The “Hardware” function and EST in the Diagnostics Mode should only be run by qualified personnel.
- A “restart” is an infrequent event.
- The gas return port on the ventilator is a cylindrical port which requires mating to a specified expiratory filter to seal the expiratory limb.
- The humidifier power connection is available only on 100-120VAC ventilators.
- Record O₂ sensor manufacturing or warranty numbers and installation date for future reference. Save manufacturers instruction about end of life replacement.
- To ensure accurate O₂ monitoring, check O₂ sensors periodically and replace as per manufacturer specification.
- Sensor performance and expected operating life information is outlined in the sensor manufacturer's instructions for use. Thoroughly review all O₂ sensor instructions prior to installation and use with the Respironics V200 Ventilator.
- O₂ sensor calibration is performed during EST. If recalibration of the O₂ sensor is required, follow the instructions in “Extended Self Test (EST)” on page 11-4 for running EST.

Warnings, Cautions, and Notes

- Medical electrical equipment needs special precautions regarding EMC and needs to be installed and put into service according to the EMC information provided in Chapter 12, "Technical Specifications".
- Speaking Mode is available ONLY in invasive ventilation mode.

(This page is intentionally blank.)

Chapter 3. Symbols

The following symbols appear on the Respironics V200 Ventilator, accessories, documentation, and packaging. Additional symbols pertaining to options and accessories are included in the documentation for each option or accessory. Refer to Chapter 13, "Options and Accessories".











Symbols	
Symbol	Description
	READ THE USER MANUAL OR ACCOMPANYING DOCUMENTS
	ATTENTION
	ON condition for part of the equipment. When pressed, the ventilator will operate from the MAINS voltage if connected or from the backup battery if the battery charge is within operating specifications.
	OFF condition for part of the equipment
	PROTECTIVE EARTH (ground)
	POTENTIAL EQUALIZATION CONNECTOR used to connect the equipment to an electrical installation earth busbar
	TYPE B applied part, which indicates equipment that provides a particular degree of protection against electric shock, particularly with regards to allowable leakage current and of the protective earth connection
	SUITABLE FOR ALTERNATING CURRENT
	DIRECT CURRENT
IPX1	DRIP PROOF
	Chart recorder ANALOG OUTPUT. Pin 12 signals an unsilenced high or medium urgency alarm: 0 VDC = active alarm, 1.5 VDC = no alarm or silenced alarm. (Voltage signal for flow and pressure reserved for future use.)
	DC BATTERY CONNECTION

Table 3-1: Symbols (Sheet 1 of 5)













Symbols (Continued)	
Symbol	Description
	DC BATTERY CONNECTION
	HOT SURFACE warning
	EUROPEAN CONFORMITY
	REMOTE ALARM connection
	RS-232 serial output
	PARALLEL PORT printer connection
	ALARM SILENCE (Silences alarm for two minutes)
	BRIGHTNESS ADJUST
	AUDIO ALARM VOLUME CONTROL
	ACCEPT
	ALARM RESET
	100% OXYGEN
	Located between the ALARM RESET and 100% O ₂ buttons, this symbol indicates that the two keys (ALARM RESET AND 100% O ₂) must be pressed simultaneously for approximately five seconds to enter Diagnostic Mode

Table 3-1: Symbols (Sheet 2 of 5)



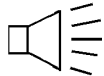











Symbols (Continued)	
Symbol	Description
	MANUAL BREATH
	EXPIRATORY HOLD
	SCREEN LOCK
	(Symbol version of the front panel only) Illuminates yellow to indicate backup battery IN USE (backup)
	(Symbol version of the front panel only) Illuminates yellow to indicate backup battery CHARGING
	(Symbol version of the front panel only) Flashes red to indicate that the backup battery is LOW
	(Symbol version of the front panel only) MAINS battery indicator
	(Symbol version of the front panel only) EXTERNAL BATTERY is in use
	DANGEROUS VOLTAGE—electrical shock hazard
	The portion of the circuit breaker that must be pushed in to turn the CIRCUIT BREAKER OFF
	The portion of the circuit breaker that must be pushed in to turn the CIRCUIT BREAKER ON
	CANADIAN STANDARDS ASSOCIATION approval.
	DATE OF MANUFACTURE
	MANUFACTURER

Table 3-1: Symbols (Sheet 3 of 5)

Symbols (Continued)	
Symbol	Description
	The product must be disposed of in accordance with the WEEE directive.
	SEALED, NON-SPILLABLE LEAD ACID BATTERY. MUST BE RECYCLED
	SEALED, NON-SPILLABLE LEAD-ACID BATTERY. MUST BE RECYCLED
	RECYCLE
	THIS SIDE UP
	AT LEAST TWO PEOPLE ARE REQUIRED TO LIFT THE VENTILATOR TO AVOID POSSIBLE PERSONAL INJURY OR DAMAGE TO THE EQUIPMENT.
	KEEP DRY
	LIMIT TEMPERATURE TO BETWEEN -20 AND 60 °C (-4 AND 140 °F)
	FRAGILE

Table 3-1: Symbols (Sheet 4 of 5)



Symbols (Continued)	
Symbol	Description
	STORE AT 10%-95% RELATIVE HUMIDITY
	Do not stack > 2 high

Table 3-1: Symbols (Sheet 5 of 5)

(This page is intentionally blank.)

Chapter 4. Getting Started

Unpacking

The Respironics V200 Ventilator has been carefully packaged to assure safe shipping. In addition, the packing container has been designed for easy unpacking. Do not discard packing materials.

Before unpacking the ventilator, examine the shipping carton(s) for visible damage. If the shipping carton(s) arrives damaged or if you suspect the contents are damaged, contact the carrier for an inspection report. If any damage is evident, we recommend that you photograph the carton(s) before the shipment is unpacked. Report any damage to the shipping container or ventilator to your local authorized Respironics distributor and to the carrier.

Save all packing material after removing the ventilator. In the event that the ventilator or backup battery needs to be repacked and reshipped, use the original packing material or order replacement material from a Respironics representative.

NOTE: The contents of the shipping carton may vary.

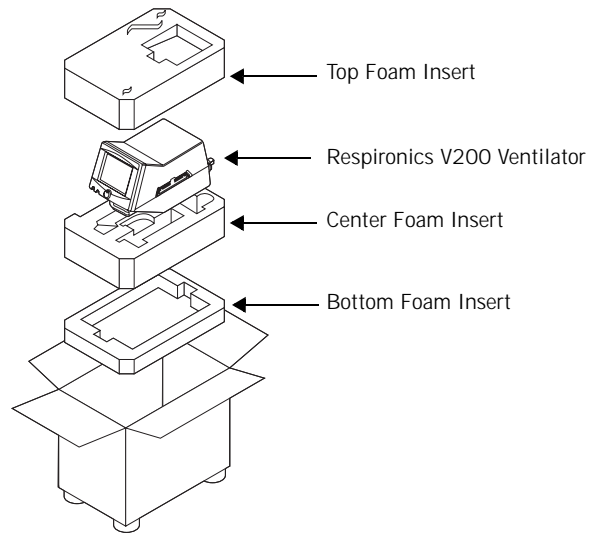

Figure 4-1: Unpacking/Repacking the Ventilator

WARNING: One person alone should not attempt to lift the ventilator or remove it from the shipping carton or the cart. At least two people are required to avoid possible personal injury or damage to the equipment.

NOTE: Medical electrical equipment needs special precautions regarding EMC and needs to be installed and put into service according to the EMC information provided in Chapter 12, "Technical Specifications".

Unpacking Instructions

Refer to Figure 4-1.

- **Tools Required:** Box knife
1. Using a box knife, cut a slit in packaging tape on top of shipping carton.
 2. Remove accessories box and optional flex arm box (not shown).
 3. Remove top foam insert from inside carton.
 4. Roll the plastic shipping bag (not shown) off the ventilator.
 5. Gently lift ventilator from the bag and carton.
 6. Remove patient circuit package (not shown).
 7. Store carton, foam insert, and plastic bag in safe place for possible future use.

Inspection

After unpacking the ventilator, inspect its cabinet exterior for damage, including cracks and scratches or blemishes. Inspect the front panel for scratches, chips, abrasions or other deformities.

CAUTION: Be sure to check all exterior parts of the ventilator. Problems found during inspection should be corrected and/or reported to Respironics before using the ventilator.

List of Parts and Accessories

Using the packing list that accompanies the ventilator, take an inventory of the entire shipment before assembling the ventilator. In case of discrepancies, immediately contact Respironics Customer Service at 1-800-345-6443.

The Esprit/V200 Ventilator Service Manual, P/N 580-1000-02, is available for qualified personnel. It includes block diagrams, components parts lists, descriptions, calibration instructions, and other information that will assist appropriately qualified personnel to repair those parts of the equipment that are designated by the manufacturer as repairable. For more information contact Respironics Customer Service at 1-800-345-6443.

NOTE: We recommend that before using the ventilator for the first time, wipe the exterior clean and disinfect or sterilize its components according to the instructions in Chapter 10, "Care and Maintenance" or the component manufacturer's instructions.

Repacking

Should the ventilator need to be returned to Respironics for servicing, or shipped elsewhere for any reason, instructions for repacking are listed below. The following instructions should be followed closely to avoid damage to the ventilator.

WARNING: One person alone should not attempt to lift the ventilator or remove it from the shipping carton or the cart. At least two people are required to avoid possible personal injury or damage to the equipment.

CAUTION: Always ship the ventilator using the original packing material. If the original material is not available, contact your Respironics representative to order replacements.

Repacking Instructions

Refer to Figure 4-1.

- **Tools Required:** Heavy duty packaging tape
1. Open carton so that bottom foam insert is facing up.
 2. Place backup battery in the bottom foam insert if it is being shipped.
 3. Place center foam insert into box on top of the bottom foam insert.
 4. If you are also shipping the flex arm, place it in its box (not shown) and place the box in the bottom of the center foam insert.
 5. Remove all power cords and accessory items from the ventilator.
 6. Set the open ventilator shipping bag (not shown) in the box on the middle foam insert.
 7. Gently place the ventilator into the open bag. Check to ensure that the ventilator is firmly positioned into bottom foam insert. Close plastic bag over the ventilator.
 8. Replace accessories box (not shown) in the center foam insert beside the ventilator (if also being shipped).
 9. Place top foam insert onto ventilator. Ensure snug fit.
 10. Close top flaps of carton and seal with heavy-duty packaging tape.

Ventilator Positioning

For information about mounting the ventilator on a table top, see the Esprit Operator's Manual (580-1000-01).

If the ventilator is on a cart, lock the cart wheels as needed as shown in Figure 4-2.

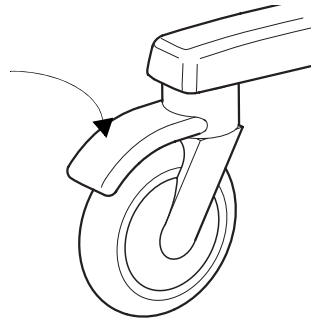

Figure 4-2: Locking Ventilator Wheel

Backup Battery

The ventilator will automatically switch to operating on backup battery power when the AC power fails or the system is disconnected from AC mains power. A fully charged backup battery will operate the ventilator for approximately 30 minutes, dependent upon the specific ventilator setting.

WARNING: The batteries (backup battery) in the battery compartment are non-spillable sealed lead acid. Recycle or dispose of batteries properly.

WARNING: Do not connect the DC power cord from the backup battery while the Respirationics V200 is functioning as a ventilator. Always turn the Power On/Off switch to off (⏻).

WARNING: Backup battery operating life may be affected by battery age and the number of times it has been discharged and recharged. Over time the battery will degenerate and will not provide the same amount of operating time per charge that is available from a fully charged new battery. Use only the Respirationics backup battery P/ N 1059956.

Backup Battery Removal and Installation

Required Tool: Philips screwdriver

Remove the backup battery from the internal packaging material and shipping bag. Do not discard packing materials until the backup battery has been installed on the ventilator and its operation has been confirmed.

NOTE: Save the shipping container in case the backup battery has to be returned to Respironics.

Figure 4-3 illustrates the backup battery assembly.



Figure 4-3: Backup Battery

1. Before the backup battery is installed, disconnect AC power and any attached equipment. Disconnect the backup battery cable connector from the rear panel of the ventilator by rotating the connector's collar nut counterclockwise while pulling back on the connector.



Figure 4-4: Disconnecting the Battery Cable

2. Remove the rear cable channel cover from the cart by gently prying it back from the top of the center column, freeing it from the column.



Figure 4-5: Removing the Rear Cable Channel Cover

3. Loosen the ventilator mounting screws (4) from the underside of the cart, and remove the ventilator from the cart.

WARNING: One person alone should not attempt to lift the ventilator or remove it from the shipping carton or the cart. At least two people are required to avoid possible personal injury or damage to the equipment.

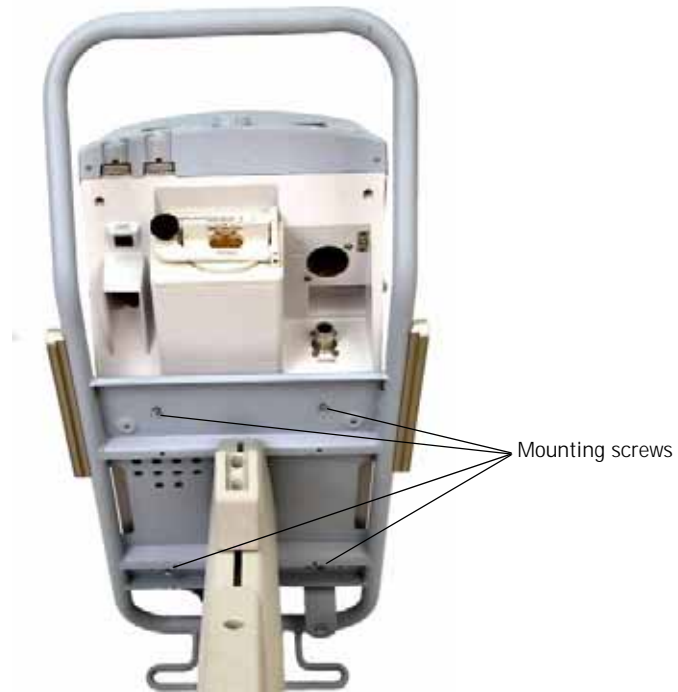

Figure 4-6: Removing the Ventilator from the Cart

4. Remove the screws (4) holding the battery tray to the cart.



Figure 4-7: Removing the Battery Tray

5. Gently pull up the battery tray and remove it from the cart.



Figure 4-8: Removing the Battery Tray

6. If a battery is present in the battery tray, disconnect the old battery from the battery tray's cable.



Figure 4-9: Disconnecting the Old Battery from the Battery Tray's Cable

7. Undo the straps, remove the old battery if present, and place the new battery in the battery tray.



Figure 4-10: Inserting Battery Into Tray

8. Position the D ring on the straps as shown below.

NOTE: If the D rings are not positioned properly, the excess strap will interfere with the tray's channel guide.

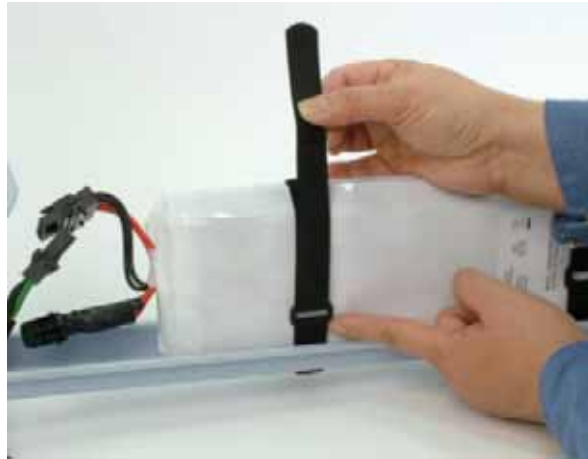

Figure 4-11: Positioning the D Rings on the Battery Straps

9. Connect the battery to the battery tray's cable.



Figure 4-12: Connecting the Battery to the Battery Tray's Cable

10. Insert the battery tray into the cart's center column by mating the battery tray's channel guide to the tray's channel guide of the center column.

CAUTION: When inserting the battery tray into the cart's center column, make sure not to crimp cable connections between the battery tray and cart.



Figure 4-13: Installing the Battery Tray

11. Slide the battery halfway down the center column, and insert the circular right angle battery connector into the cutout. Pull the cable downward as the tray is fully inserted into the cart's center column.



Figure 4-14: Inserting the Circular Right Angle Battery Connector Into the Cutout

12. Fasten the battery tray to the cart using the 4 screws used when the tray was removed.



Figure 4-15: Battery Tray Mounting Screws

13. Set the ventilator back on the cart, ensuring that the four ventilator feet meet the four circular recesses on the top of the cart. Tighten the four mounting screws that were loosened in step 3.



14. Routing the backup battery cable from the tray between the rear of the ventilator and the rear handle of the cart, connect the cable to the circular battery connector on the back of the ventilator. Snap the rear channel cover back into place.



Figure 4-16: Backup Battery Connector

15. Plug the ventilator into an AC outlet.
16. Allow the backup battery to charge as required (see "Battery Charging" on page 4-15).
17. When charging is complete, attach a patient circuit and turn the ventilator on in the diagnostics mode. Select the User Config touch key and enable the Backup Battery confirmation feature (refer to Chapter 5, "Backup Battery").
18. Run SST (refer to Chapter 11, "Diagnostics").
19. After SST has been successfully completed, exit the diagnostics mode and power up the ventilator in the normal ventilation mode.
20. While the ventilator is cycling, unplug the AC power from the wall.
21. The ventilator should continue ventilation without interruption of any kind.
22. The ventilator should have the "In Use" indicator (text version of front panel) or the battery symbol  (symbol version of the front panel) on and a non-silenceable, non-resettable audible alarm should sound every 60 seconds. "Backup Battery On" is displayed while the ventilator consumes power from the backup battery.
23. Plug the AC wall power back in and the ventilator should continue ventilation without interruption of any kind.

Backup Battery Operation

When the backup battery is attached and the Respironics V200 Ventilator is operating in normal ventilation mode anytime there is a loss of AC power, the ventilator will automatically switch to battery power and continue ventilation without interruption. Whenever the ventilator is powered by the backup battery, it will generate a non-silenceable, non-resettable alarm that creates an alarm sound every 60 seconds. During this state, the front panel indicator labeled "In Use" (text version of the front panel as shown in Figure 4-17), or the battery symbol  (symbol version of the front panel as shown in Figure 4-18) will illuminate yellow continuously. In addition, "Backup Battery On" is displayed.

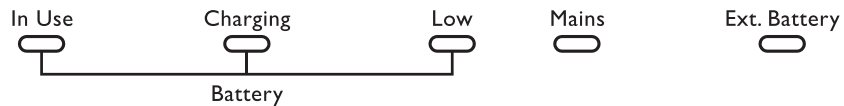



Figure 4-17: Backup Battery Front Panel Indicators — Text Version



Figure 4-18: Backup Battery Front Panel Indicators — Symbol Version

Operation will continue in this state until the battery capacity is nearly expended. When the battery has only about 5 minutes of operation left, an audible, nonresettable, HIGH priority alarm will sound. When this happens, the red, front panel indicator labeled "Low" (text version of the front panel as shown in Figure 4-17), or the low battery symbol  (symbol version of the front panel as shown in Figure 4-18) and the high priority alarm LED will flash continuously. In addition, "Low Backup Battery" is displayed.

WARNING: When the battery low indicator is flashing red, operation of the ventilator from the battery power should be discontinued.

When power is finally depleted, the ventilator will open the Safety Valve and terminate ventilation in an orderly fashion. In this state, the front panel displays "Backup Battery Depleted-Connect AC & Cycle Power." The backup alarm emits a continuous tone, the high priority alarm LED flashes, and the Safety Valve, Vent Inop, and Battery Low front panel indicators remain lit until power from the Backup Battery is completely gone.

Battery Capacity

There is a great deal of variability in the power consumption of the ventilator depending on altitude, ventilator settings, and the age and amount of charge on the backup battery. These parameters will determine the exact amount of time the ventilator can operate from the backup battery.

Battery Charging

When the ventilator is plugged into a viable AC supply, it will charge the backup battery if the Mains Circuit Breaker is on and the machine is operating as a ventilator, or in diagnostic mode or the Power ON/OFF switch is OFF (⏻). Charging time will depend on the amount of charge the batteries require. A fully discharged backup battery will be fully recharged within 10 hours. If the backup battery does not reach a full charge within 10 hours, contact Respironics Customer Service. While the ventilator is charging, the front panel indicator labeled "Charging" (text version of the front panel as shown in Figure 4-17) or the charging battery symbol  (symbol version of the front panel as shown in Figure 4-18) will be on continuously. When the backup battery is fully charged, the indicator will turn off.

NOTE: For optimal performance and battery life of a newly purchased backup battery, establish full backup battery charge by plugging the ventilator into AC power for eight (8) hours maximum, or until the charging indicator light turns off, and then unplug the unit.

NOTE: To monitor backup battery performance and life, run the ventilator on battery power for at least 20 minutes at typical settings once a month. Recharge the battery when the test is complete.

CAUTION: The backup battery is designed to be charged only by the Respironics V200 Ventilator. Under no circumstances should an attempt be made to charge it in any other way.

CAUTION: If the ventilator will not be used for 30 days or more, the backup battery should be preserved. Either disconnect the backup battery from the ventilator or keep the ventilator plugged into an active electrical outlet.

Warranty

Respironics warrants the backup battery to be free from defects in material and workmanship for a period of one year from the date of purchase, provided that the unit is operated under conditions of normal use as described in this operator's manual.

At its discretion, Respironics will make replacements, repairs or issue credits for equipment or parts that are found to be defective.

Inspiratory Bacteria Filter Installation

The inspiratory bacteria filter (4) in Figure 4-19, mounts on the gas outlet port (1) located in the lower right corner on the front of the ventilator. If the optional O₂ sensor (2) will be used, it will be connected to the gas outlet port (1) before the inspiratory bacteria filter is connected. For more information regarding the optional O₂ sensor, refer to Chapter 13, "Options and Accessories".

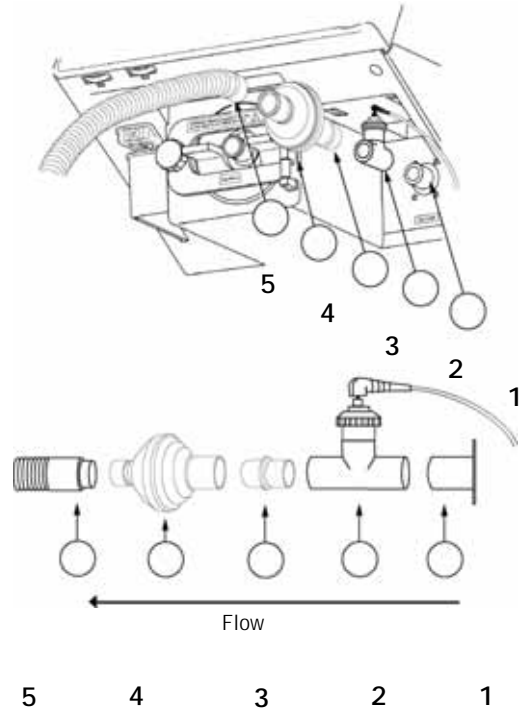

Figure 4-19: Inserting Disposable Inspiratory Bacteria Filter

WARNING: To reduce the chance of contamination or infection, always use an inspiratory and expiratory filter when the ventilator is in operation. Refer to manufacturer's instructions and follow institutional infection control guidelines when replacing the inspiratory and expiratory filter.

WARNING: Do not use anti-static or conductive hoses or conductive patient tubing.

NOTE: Follow institutional infection control guidelines when replacing the inspiratory or expiratory bacteria filter.

NOTE: When adding attachments or other components or subassemblies to the breathing system, for example, an HME or humidifier, ensure that the inspiratory and expiratory resistances (measured at the patient connection port) do not exceed 6 cmH₂O (hPa) at a flow of 60 L/min for adults, 30L/min for pediatrics.

Inspiratory Bacteria Filter Installation Instructions

Refer to Figure 4-19.

1. Locate the gas outlet port (1) on the front panel.
2. If the optional O₂ sensor (2) will be used, connect it to the gas outlet port (1).
3. Remove the inspiratory bacteria filter from the filter package and inspect for cracks or potential leaks. Discard the filter if it is cracked, has moisture inside, or is otherwise unserviceable.
4. Some bacteria filters provide an arrow or other mark to indicate the direction of flow. The flow indicator should be pointed away from the ventilator, toward the patient circuit connection
Insert inspiratory filter inlet (4) into either
 - the optional O₂ sensor (2) using the 22mm connector (3)
 - or
 - the gas outlet port (1) if the optional O₂ sensor (2) is not used.
5. Connect inspiratory limb of patient circuit (5) to bacteria filter (4).

Heated Expiratory Bacteria Filter Installation

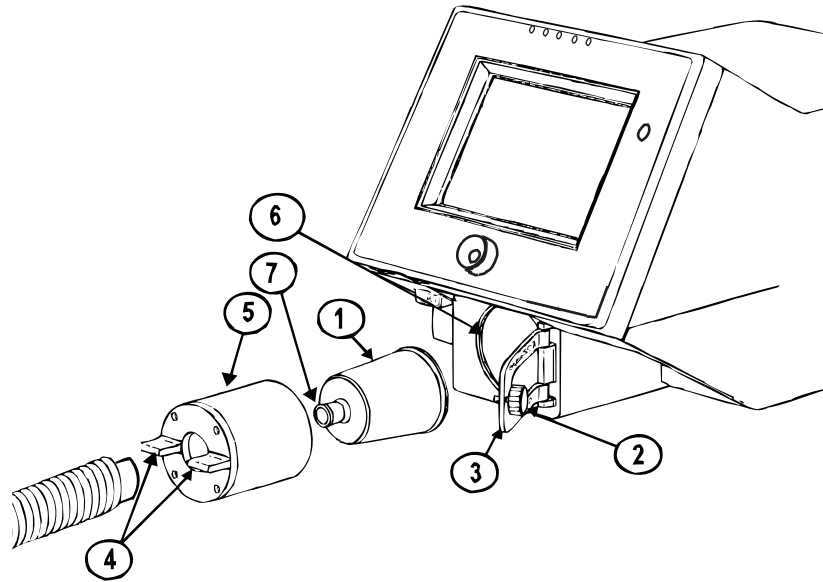

Figure 4-20: Installing Expiratory Bacteria Filter

WARNING: The expiratory filter housing may be hot if removed from the ventilator immediately after use. Wait 15 minutes after turning off ventilator power before removing the heated expiratory bacteria filter. Exercise caution when handling the filter housing.

CAUTION: Do not operate the ventilator without a properly functioning expiratory filter and heater. Doing so may cause damage to delicate ventilator components, such as the expiratory flow sensor, which may lead to inaccurate spirometry or a Vent Inop condition.

WARNING: Vent Inop is a serious condition, which is indicated by both visual and audible alarms. If the ventilator is attached to a patient when Vent Inop occurs, the patient must be supported with another means of life support ventilation.

NOTE: Follow institutional infection control guidelines when replacing the inspiratory or expiratory bacteria filter.

NOTE: When adding attachments or other components or subassemblies to the breathing system, for example, an HME or humidifier, ensure that the inspiratory and expiratory resistances (measured at the patient connection port) do not exceed 6 cmH₂O (hPa) at a flow of 60 L/min for adults, 30L/min for pediatrics.

Heated Expiratory Bacteria Filter Installation Instructions

Refer to Figure 4-20.

1. Locate the heated expiratory bacteria filter (1) and receiving compartment (6) in the lower center of front panel.
2. Turn knob (2) counterclockwise to unlatch retaining bracket (3).
3. Open retaining bracket (3) by pulling it out and away from the ventilator.
4. Use tabs (4) to gently pull the heater housing (5) away from the ventilator.
5. Ensure that ventilator has been turned off for 15 minutes. If not, allow the heater housing (5) to cool before touching it with fingers.
6. Gently remove the heater housing (5). Tap filter input port (7) if the filter does not come out easily.
7. Insert the new expiratory bacteria filter (1) into the heater housing (5).
8. Reinstall housing (5) and filter (1) into receiving compartment (6), then close retaining bracket (3).
9. Ensure that the retaining bracket (3) is securely closed and turn knob (2) clockwise to secure latch.
10. Connect the exhalation limb and water collection system of the patient circuit (not shown) to the inlet port of the exhalation filter (7).

NOTE: High humidity and aerosol medications may reduce expiratory filter life, increase expiratory resistance, and/or cause filter damage. Review ventilator patient graphics frequently for changes in expiratory resistance. Consult filter manufacturer recommendations regarding duration of use, maintenance, and removal and disposal of expiratory filter.

Oxygen Source Connection

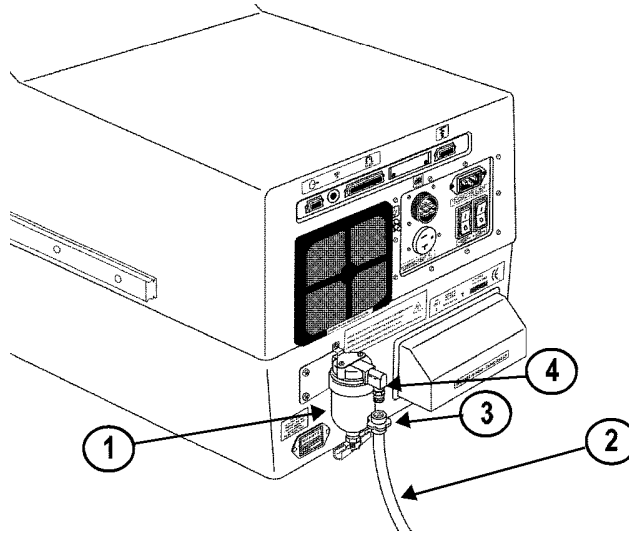

Figure 4-21: O₂ Gas Connections and Filter

WARNING: All oxygen connections should be carefully inspected to ensure that leaks are not present. Excessive leaks can result in higher than normal ambient oxygen concentrations and create a potentially hazardous oxygen-enriched environment.

WARNING: Worn/frayed oxygen hoses or oxygen hoses contaminated by hydrocarbon greases or oils should not be used since an oxygen leak or intense fire could result.

WARNING: Care in the routing of the oxygen inlet hose should be exercised to ensure it is not exposed to mechanisms that could cause damage by cutting or heating/melting.

CAUTION: The ventilator oxygen filter should be replaced annually as a part of preventive maintenance.

NOTE: The ventilator should only be connected to an appropriate medical grade 100% O₂ gas source capable of delivering a regulated 40 to 90 PSIG (276-620 kPa).

NOTE: The ventilator is shipped with the appropriate gas fittings and hoses for the intended environment, i.e. DISS (U.S.A. and Canada), Ohmeda (Germany), NIST (UK), Air Liquide (France), SIS (Australia).

Oxygen Source Connection Instructions

Refer to Figure 4-21.

1. Locate the O₂ filter with water trap (1) located in the lower left corner of the rear panel.
2. Ensure that the O₂ filter and water trap (1) are properly attached to the ventilator. Inspect the bowl (1) for cracks or potential leaks. Ensure all connections are tight.
3. Inspect the O₂ hose (2), hose connector (3) and the hose connector mate (4).
4. Check the oxygen gas supply. Clean, adjust pressure, and drain condensate from any water traps, filters, or regulators in the O₂ supply lines.
5. Connect O₂ gas connector (3) to the ventilator O₂ filter with DISS hose connector (4).
6. If gas source is not already turned on, turn it on and verify that no O₂ gas is leaking.

Patient Circuit Flex Arm Installation

A patient circuit flex arm is provided for use on the ventilator. The patient circuit flex arm may be installed on either the left or right side rail on the cart.

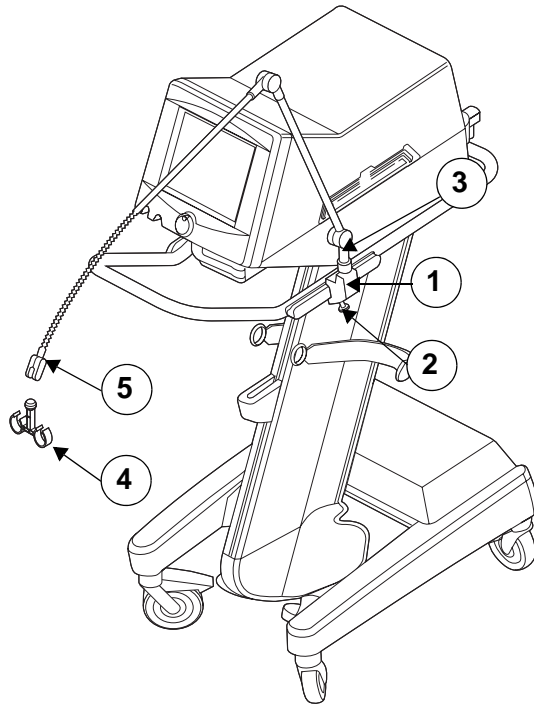

Figure 4-22: Patient Circuit Flex Arm Installation

Patient Circuit Flex Arm Installation Instructions

Refer to Figure 4-22.

1. Slide flex arm bracket (1) on to the side rail of the cart (one per side).
2. Tighten black screw knob (2) on flex arm bracket.
3. Insert base of flex arm (3) into flex arm bracket and tighten.
4. Place patient circuit hose clamp (4) into the flex arm clamp (5) and tighten.

Chapter 5. Setup

Back Panel Connections and Controls

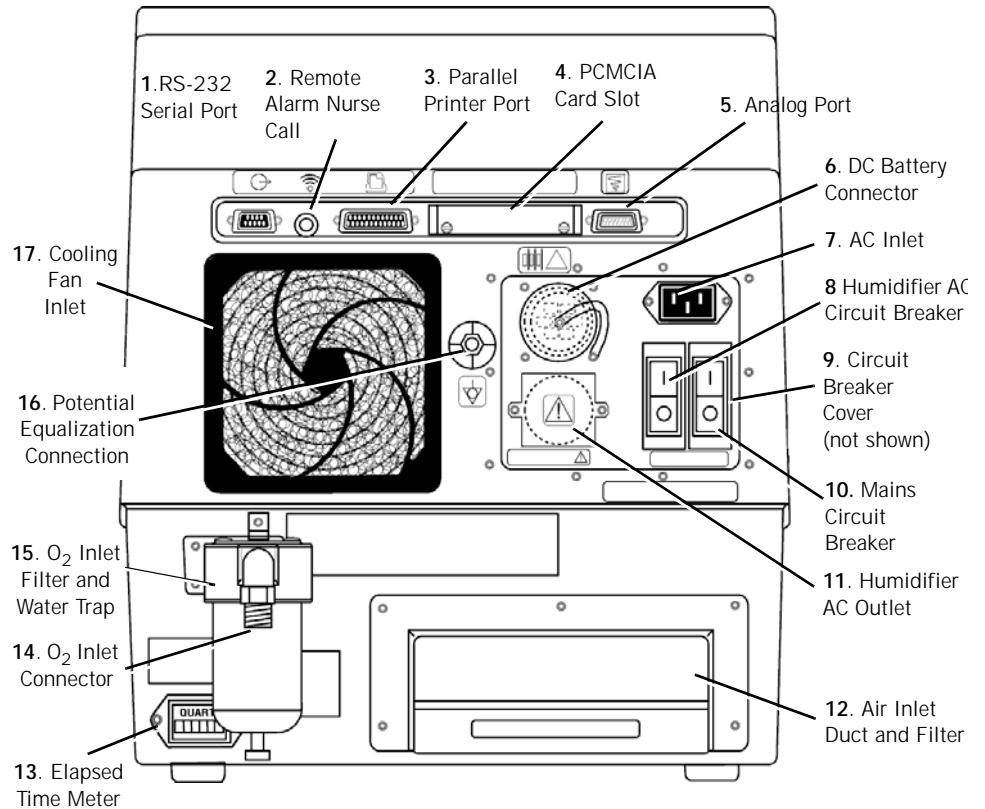

Figure 5-1: Back Panel

1. **232 Serial Port:** Connection source for devices capable of serial communication. Refer to Chapter 6, "Connecting Additional Equipment".
2. **Remote Alarm Nurse Call:** Connection source for remote alarm devices.
3. **Parallel Printer Port:** For use with the Communications Option. Refer to Chapter 13, "Options and Accessories".
4. **PCMCIA Card Slot:** (PC Card) For use with the Trending Option. Refer to Chapter 13, "Options and Accessories".

WARNING: The cover plate for the PCMCIA slot at the back of the ventilator must be replaced after the adapter and card are installed. This is to protect the ventilator.

CAUTION: The PCMCIA card should only be removed by trained service personnel once power to the ventilator is off.

5. **Analog Port:** Pin 12 signals an unsilenced high or medium urgency alarm. Other pins are used by the Communications Option. Refer to Chapter 13, "Options and Accessories".
6. **DC Battery Connector:** Connection source for battery power cord.
7. **AC Inlet:** Connection for AC power cord.
8. **Humidifier AC Circuit Breaker:** Circuit breaker for AC power applied to a humidifier.

WARNING: AC power is applied to the humidifier from the ventilator humidifier outlet (only available on 100-120 VAC ventilators). Under no circumstances does the Respirationics V200 Ventilator provide control for the humidifier. To ensure patient safety, it is important that any humidifier used with the ventilator include an acceptable temperature control and monitoring mechanism, as well as a temperature display and appropriate alarm capabilities (refer to ISO 8185).

CAUTION: To avoid the possibility of damage to the ventilator, do not connect a humidifier whose maximum rating exceeds 3 amps. Ensure that the humidifier power cord is free from defects and any obvious wear, and is properly grounded. A humidifier connection is only available on 100-120VAC ventilators.

9. **Circuit Breaker Cover:** Circuit breaker cover (not shown) protects the Humidifier AC Circuit Breaker and Mains Circuit Breaker switches.
10. **Mains Circuit Breaker:** Circuit breaker for main AC circuit.
11. **Humidifier AC Outlet:** Connection for Humidifier AC power cord.
12. **Air Inlet Duct and Filter:** Filters room air drawn into the ventilator internal air source.
13. **Elapsed Time Meter:** Records time when the Power On/Off Switch is on (⊙).
14. **O₂ Inlet Connector:** Connection for oxygen hoses.
15. **O₂ Inlet Filter and Water Trap:** Filters oxygen entering the ventilator.
16. **Potential Equalization Connection:** Common grounding point.
17. **Cooling Fan Inlet:** Allows cooling air to enter the ventilator.

NOTE: All volumes entered into the ventilator are assumed to be BTPS (Body Temperature atmospheric Pressure Saturated (with H₂O)) volumes unless otherwise noted. All volumes reported by the ventilator are reported as BTPS volumes. All pressures are assumed to be relative to atmospheric pressure unless otherwise noted.

NOTE: The Air Inlet Filter houses a reusable foam filter that should be periodically cleaned. Refer to Chapter 10, "Care and Maintenance", for more information on filter changes.

Connecting AC Power Cord

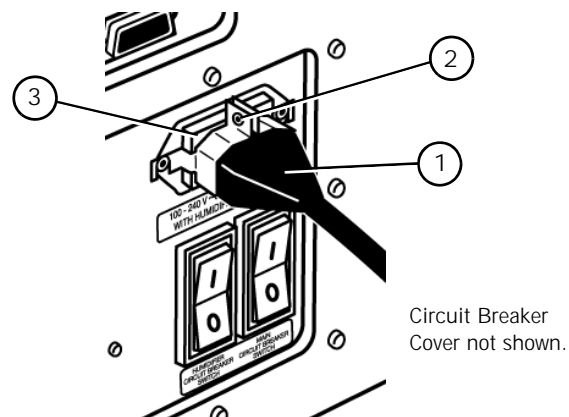

Figure 5-2: AC Power Cord Retaining Bracket

WARNING: To avoid electrical shock hazard, connect the ventilator to a properly grounded AC power outlet.

CAUTION: Before connecting the ventilator to the AC power source, ensure that the total electrical load does not exceed the ampere rating of the AC branch circuit, especially when using the ventilator with other electrical equipment. An AC branch circuit includes all outlets serviced by a single circuit breaker. If the maximum current drain through a branch circuit exceeds the circuit breaker's rating, the branch circuit will open, causing the ventilator to lose power. For further information, consult a service technician or a trained biomedical technician.

CAUTION: The ventilator is shipped with a power cord that complies with electrical safety standards. Do not use substitute power cords unless specifically instructed to do so by an authorized distributor or qualified personnel. Do not modify the power cord or connect it with electrical extension cords or outlet adapters.

Connecting AC Power Cord Instructions

Refer to Figure 5-2.

- **Tools Required:** Small Phillips screwdriver
1. Ensure that the ventilator is properly positioned on a secure table top, wall mount, or pedestal.
 2. Connect the AC Power Cord (1) to the AC inlet (3) located on the rear panel. (Refer to Figure 5-1.)
 3. After cord is fully inserted, tighten the retaining bracket screw (2) so that the power cord cannot be inadvertently disconnected from the ventilator.

Power On/Off

The ON/OFF (⊙/⊖) switch is located in the lower portion of the front panel, and is recessed to avoid inadvertent access.

When the switch is in OFF (⊖) position, the ventilator does not provide mechanical ventilation. If the AC plug is connected and the Mains circuit breaker (refer to Figure 5-1) is ON (I), AC power is active and the green Mains circuit indicator on the front panel, is illuminated.

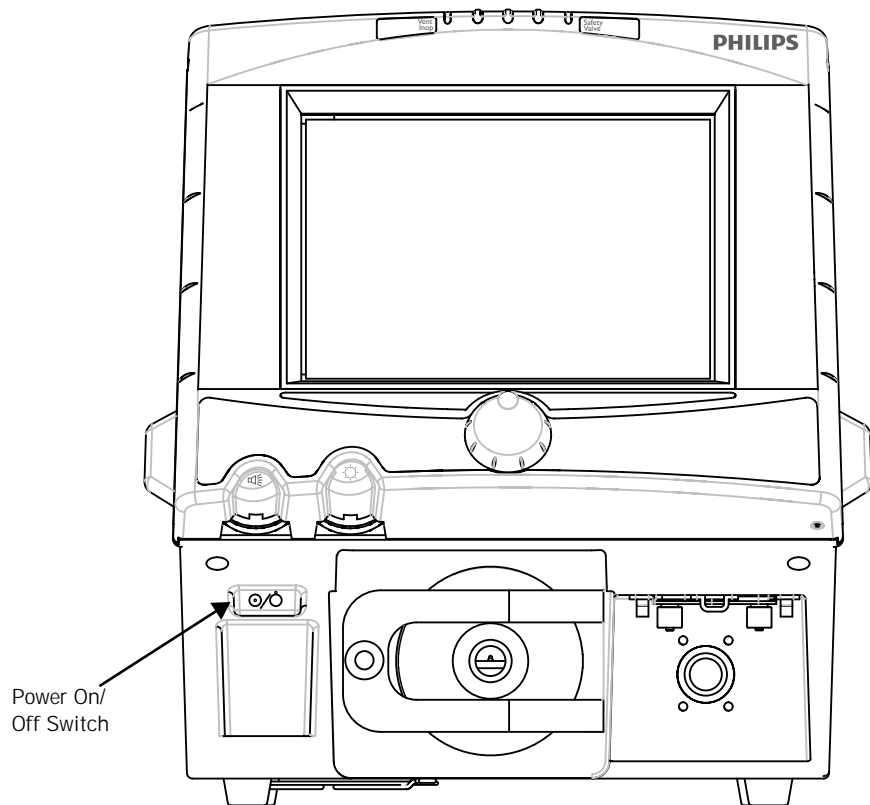

Figure 5-3: On/Off Switch

Turning the Ventilator On

1. Ensure that the Mains Circuit Breaker (refer to Figure 5-1), located on the ventilator back panel, is in the ON (I) position.
2. For 120V applications, if a humidifier is attached to the ventilator, ensure that the Humidifier AC Circuit Breaker (refer to Figure 5-1), located on the ventilator back panel, is in the ON (I) position. A humidifier connection is only available on 100-120VAC ventilators.
3. Press the Power ON/OFF switch to the ON (Ⓞ) position (left side up).

WARNING: The ventilator front panel LEDs will indicate the power source that is being used. If the ventilator is plugged in and the MAINS LED is not lit, either the circuit breaker is off or the wall power outlet is not functioning.

Turning the Ventilator Off

1. Press the Power ON/OFF Switch to the OFF (Ⓞ) position (right side up).

WARNING: The two circuit breakers (MAINS/Humidifier) located on the back of the ventilator are covered to prevent unintentional ventilator power-off. Do not use the circuit breaker to power the ventilator on/off. The power switch is located on the front of the ventilator below the front panel.

NOTE: Unless the Mains Circuit Breaker is turned OFF, electrical power is applied to the ventilator even though the front panel switch is in the OFF position. With the Mains Circuit Breaker ON, if the backup battery is connected, the ventilator will charge the battery if it requires a charge.

NOTE: To disconnect the ventilator from MAINS power, remove the AC plug from the wall power receptacle. The MAIN switch/circuit breaker is covered to prevent unintentional ventilator turn off.

Entering Diagnostic Mode

The Diagnostic Mode is used for:

1. Running tests of the operation of the ventilator that can only be run when a patient is not attached to the machine.
2. Setting altitude, time and date, and circuit compliance.
3. Other more detailed service/maintenance functions.
4. Calibration of inline Oxygen Sensor, during EST only.

Some of these functions are discussed in detail in Chapter 12, "Technical Specifications". The functions of the Diagnostic Mode that are used to make the machine ready for use as a ventilator when it is first put into service are explained here.

Entering Diagnostic Mode

1. To access the Diagnostic Mode, simultaneously press the ALARM RESET and 100% O₂ keys on the front panel for approximately five seconds while turning the ventilator power on. The following message will appear on the screen:

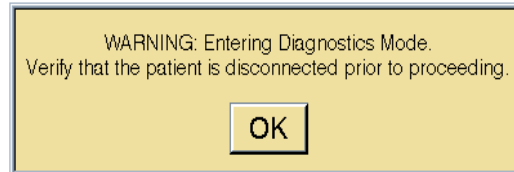

Figure 5-4: Warning in Diagnostic Mode

2. Press the OK button to enter the Diagnostic Mode. The following screen appears:

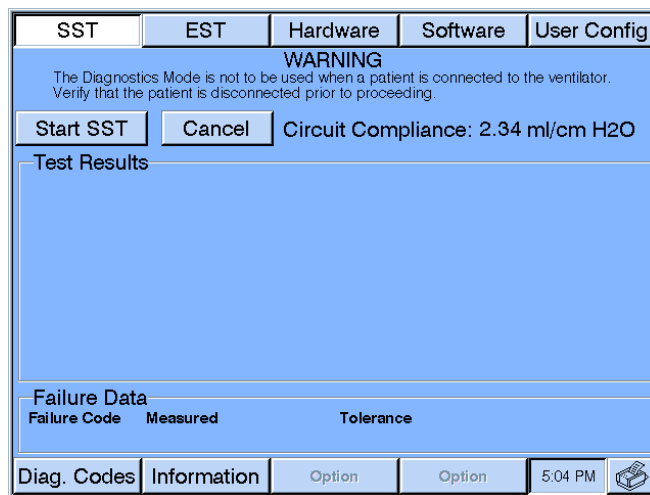

Figure 5-5: Main Screen in Diagnostic Mode

User Configuration Screen

The buttons across the top and bottom bars are used to select the Diagnostic Mode functions. To set up the machine for the first time for operation as a ventilator, USER CONFIG should be selected. When this button is pressed, the following screen appears.

SST	EST	Hardware	Software	User Config
WARNING The Diagnostic Mode is not to be used when a patient is connected to the ventilator. Verify that the patient is disconnected prior to proceeding.				
Month	12	Altitude	0	Compliance
Day	31			24hr Clock
Year	1997			Bkup Battery
Apply Date				
Hour	23			
Minute	59			
Second	59			
Apply Time				
Diag. Codes	Information	Option	Optim	3:10 PM

Figure 5-6: User Configuration Screen

The User Configuration screen allows the operator to:

- Set the date and time
- Activate or deactivate the automatic patient circuit compliance compensation feature
- Set the proper altitude
- Set 24 Hrs/AM PM time display
- Activate or deactivate backup battery check at startup

Date and Time

The real-time clock and calendar will last for approximately 2.5 years. When the ventilator is received, the clock's time will have to be changed to that of the existing time zone. The date should be checked and changed if necessary.

Setting Date and Time Format

To set time (Figure 5-8) or date (Figure 5-7):

1. Press the desired date or time button (month, day, year, hour, minute, second).
2. When the window insert appears, press the INCREASE or DECREASE button, or rotate the control knob to change the value of the selected parameter.

3. Press the ACCEPT button to confirm the change and return to the User Config screen. Press the CANCEL button to leave the value unchanged.

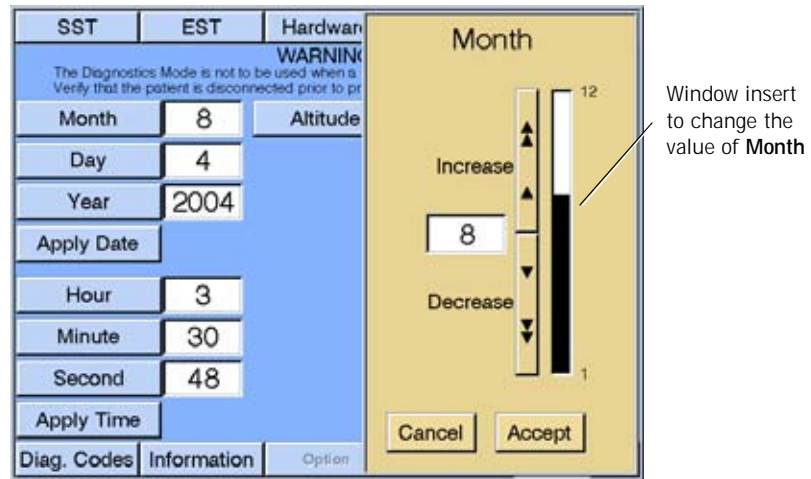

Figure 5-7: Setting the Date

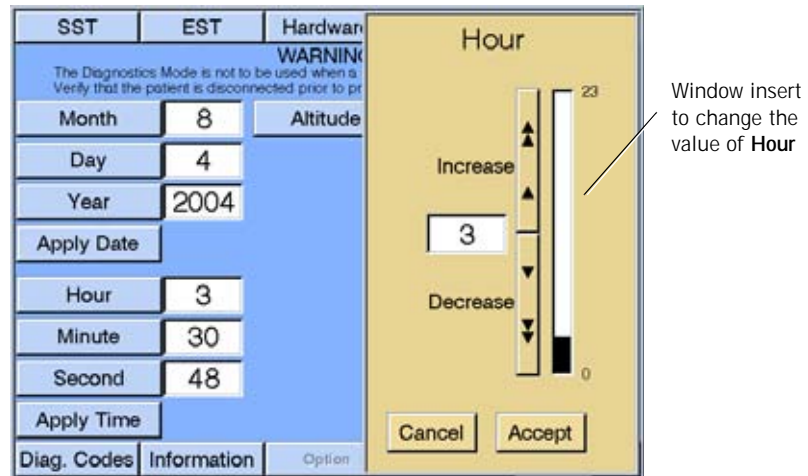

Figure 5-8: Setting the Time

4. After the date and time values have been set, the changes will be shown on the screen.
5. Press the APPLY DATE and APPLY TIME buttons to activate the change.

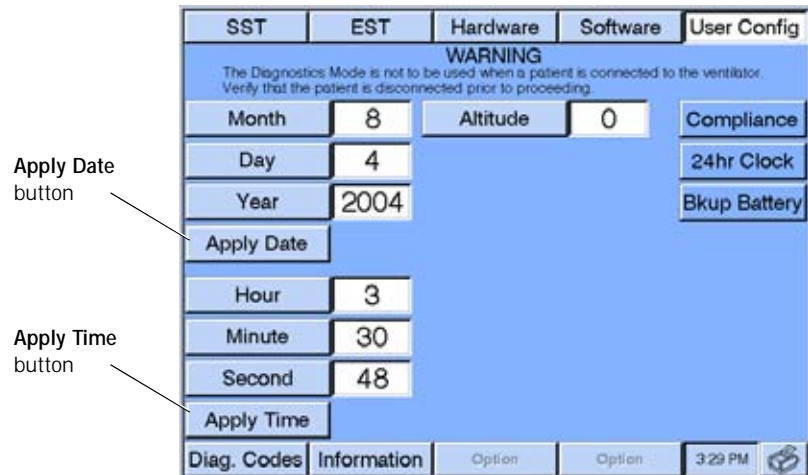

Figure 5-9: User Configuration Screen After Date and Time are Set

6. The 24 HR CLOCK button allows the operator or technician to set the displayed time in an AM/PM (e.g., 1:15 PM) or 24 Hr. (e.g., 13:15) format. When the 24 HR CLOCK button has a white background, time is displayed in the 24 Hr. format; when it has a gray background, time is displayed in the AM/PM format.
7. Press the 24 HR CLOCK button to toggle between AM/PM and 24 Hr. formats. Observe the time display in the lower right hand corner of the diagnostic screen to confirm the format.

Altitude

The User Configuration screen in the Diagnostic Mode is used to input the altitude of the location of the ventilator. To enter Diagnostic Mode, follow the instructions "Entering Diagnostic Mode" on page 5-6. At Figure 5-5 select USER CONFIG and the screen in Figure 5-10 appears. Pressing the ALTITUDE button enables you to set the altitude to that of the present geographical location of the ventilator. This factor ensures a more accurate tidal volume delivery.

Setting Altitude

To adjust the altitude:

1. Verify the altitude using an altimeter, if available, or estimate the altitude in feet (or meters) above sea level.
2. Press the ALTITUDE button.
3. When the window insert appears, select either feet or meters. Press the INCREASE or DECREASE button, or rotate the control knob, to change the value. The longer the increase and decrease are touched, the faster the value will change.

4. Press ACCEPT to accept the changed value. Press the CANCEL button to leave the value unchanged.

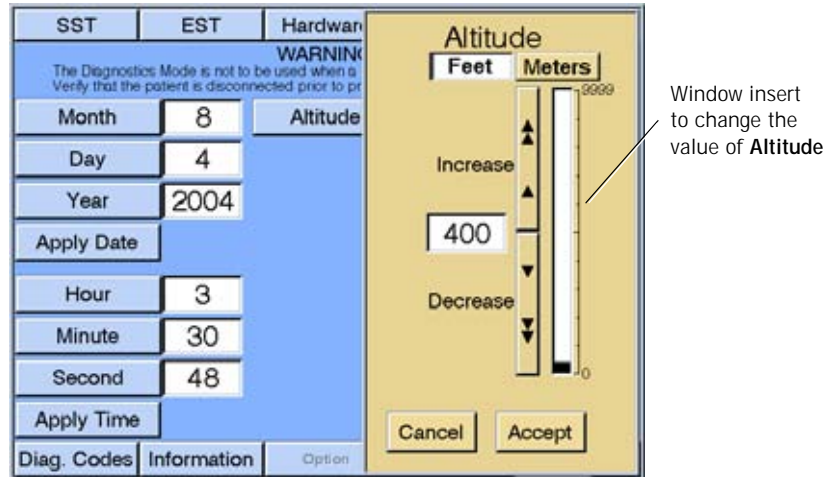

Figure 5-10: Setting Altitude

Enabling/Disabling Tubing Compliance

The operator can activate or deactivate “tubing compliance compensation” in the User Configuration screen. To enter Diagnostic Mode, follow the instructions for “Entering Diagnostic Mode” on page 5-6. At Figure 5-5, select USER CONFIG and the screen in Figure 5-11 appears.

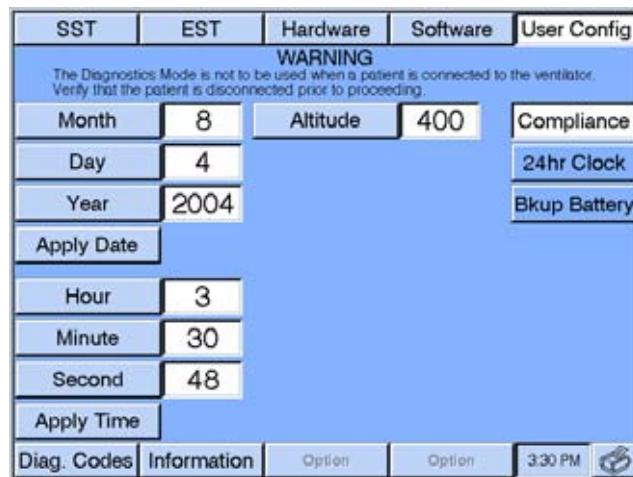

Figure 5-11: Compliance Activated

You can have the ventilator compensate the volumes delivered in volume controlled, mandatory breaths with the tubing compliance volume by activating the COMPLIANCE button (Figure 5-11). Circuit compliance is activated when this button has a white background. When the function is activated the exhaled volumes reported by the ventilator will also be tubing compliance compensated.

Backup Battery

You can have the ventilator confirm the backup battery is connected each time that the machine powers on. Pressing the BKUP BATTERY button (Figure 5-12) allows this confirmation feature, which is identified by an active button with a white background.

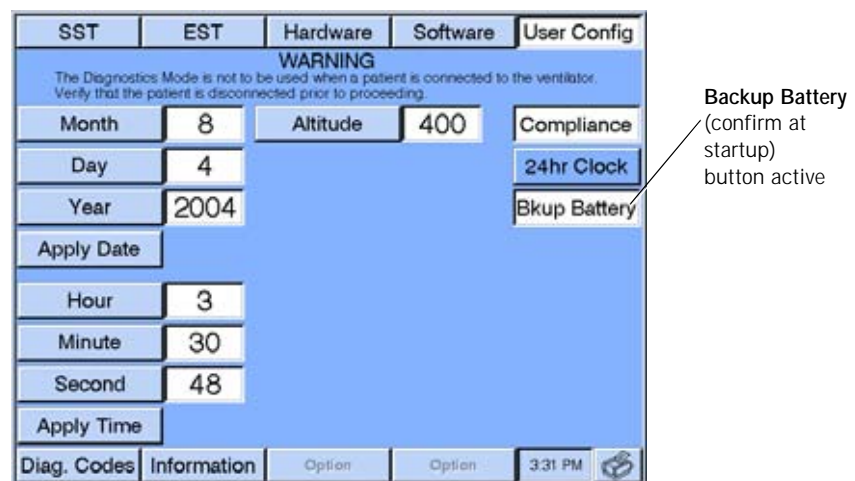

Figure 5-12: Backup Battery Activated

From then on when the machine powers on, it searches for a backup battery. If the backup battery is connected to the ventilator, the startup is normal. If the backup battery is not connected, the ventilator displays a message at startup and a 5002 Diagnostic Code will be logged.

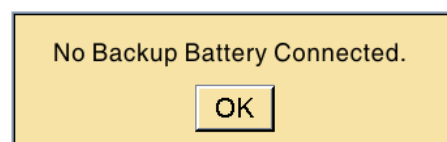

Figure 5-13: No Backup Battery Connected message

Press the OK button to clear the message from the screen. You may continue to use the ventilator without the backup battery or power off the ventilator and reconnect the backup battery.

WARNING: Always turn the ventilator power OFF before connecting additional equipment.

To turn this feature off, enter Diagnostic Mode and deactivate the messaging feature by pressing the BKUP BATTERY button.

1. Power off the ventilator.
2. Power on the ventilator while holding down the ALARM RESET and 100% O₂ keys simultaneously for approximately 5 seconds.
3. A message appears on the ventilator screen asking the user to 'Verify that the patient is disconnected prior to proceeding.' Press OK to enter Diagnostic Mode.
4. Once you've entered Diagnostic Mode, select USER CONFIG button, which takes you to the User Config screen.
5. Press the BKUP BATTERY button. The background color should return to blue signifying that this feature has been deactivated.

Extended Self Test (EST)

We recommend that you run an Extended Self Test (EST) upon receipt of the ventilator to ensure that there has been no shipping damage to the system. We also recommend that you run EST between patients to verify the overall functional integrity of the ventilator. Refer to chapter 11 for instructions on running EST.

If EST was run successfully and all configuration information has been entered, the ventilator is ready to be used. Follow the recommended "Preoperational Procedure" on page 8-32 once a patient has been selected.

To exit the Diagnostics Mode you must turn the Power On/Off switch OFF (⏻) and then turn it ON (⏻).

Chapter 6. Connecting Additional Equipment

WARNING: Always turn the ventilator power OFF before connecting additional equipment.

Communication Interface

CAUTION: To prevent the risk of excessive leakage due to external equipment being connected to the ventilator via the communication ports, a means for external separation of the conductive earth paths must be provided.

CAUTION: All equipment used and connected to the ventilator communications ports (analog, parallel, and serial) must comply with the medical electrical equipment (IEC601-1) or other applicable standards.

The ventilator provides three communications interfaces: one serial RS-232 port, an analog output port, and a parallel port. (The parallel port is reserved for use by the Communications Option.)

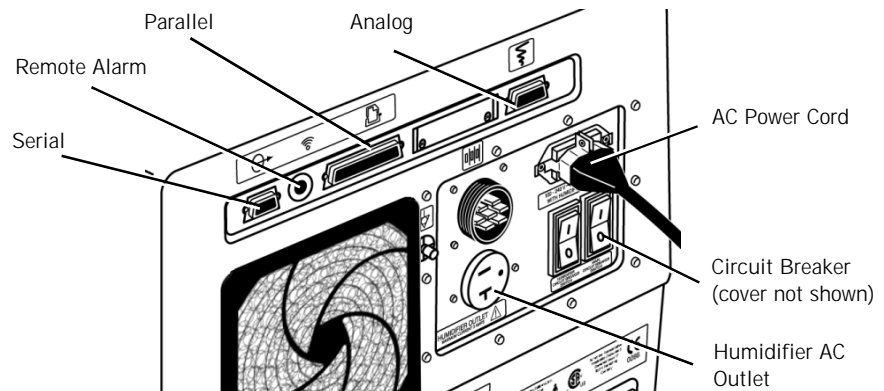

Figure 6-1: Ports and Outlets on the Rear Panel

Connecting Additional Equipment

Connecting Serial Communications Devices

The serial port is designed to transmit data on a one device to one device serial communications channel. In the connection between the two devices, the ventilator assumes the "slave" role and responds to commands transmitted to it via the serial port by the external "master." The serial communications port uses a standard RS-232, null modem, pin configuration. The ventilator assumes the serial communications is set up for:

- 19,200 bits/second baud rate
- 8 data bits
- no parity bit
- 1 stop bit

The ventilator is sent commands that are 4 ASCII characters from the external device and responds with a fixed format message. The commands and the responses are specified in Appendix A, "RS-232 Communications Protocol".

Connecting Remote Alarm Port

The ventilator is equipped with a remote alarm port enabling ventilator alarm conditions to be sounded at remote locations away from the ventilator. Pressing ALARM SILENCE deactivates the remote alarm. The ventilator signals an alarm using a normally open or normally closed relay contact. The de-energized state of the relay represents an alarm state (any Medium or High Priority alarm) and the energized state represents no alarms.

The remote alarm port is a standard ¼ inch, female, phono jack (ring, tip, sleeve) connector.

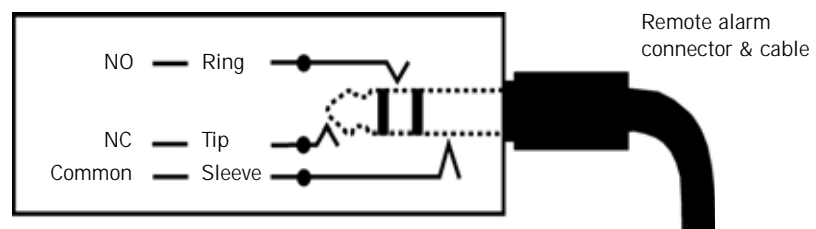

Figure 6-2: Remote Alarm Port

The port is configured to work with the Normally Open (NO), Normally Closed (NC), and Respiration (LifeCare) systems. Each requires specific cabling identified in Table 6-1:.

Connecting Additional Equipment

Remote Alarm Cable Kits	
System	Part Number
Remote Alarm Cable Kit (Normally Open Protocol)	1003741
Remote Alarm Cable Kit (Normally Closed Protocol)	1003742
Remote Alarm Cable Kit — Respironics (LifeCare)	1003743

Table 6-1: Remote Alarm Cable Kits

WARNING: Use only Respironics approved cables when connecting to the remote alarm port. Be sure to fully insert the cable into the remote alarm port and into the remote alarm.

WARNING: When using the Remote Alarm Port, be sure to fully test the Remote Alarm Port and cable by:

- Verifying that annunciated alarms on the ventilator are also annunciated on the remote alarm.
- Verifying that disconnecting the cable from the Remote Alarm port results in an alarm notification at the Remote Alarm.
- Verifying that disconnecting the cable from the remote alarm results in an alarm notification at the Remote Alarm.

CAUTION: The remote alarm port is intended to connect only to SELV (safety extra low voltage and ungrounded system with basic insulation to ground), in accordance with IEC60601-1. To prevent damage to the remote alarm, the signal input should not exceed the maximum rating of 24 VAC or 36 VDC at 500 mA with a minimum current of 1 mA.

Connecting Humidifier

We recommend only those humidifiers that comply with ISO 8185 for use on the ventilator.

You should consult with the manufacturer(s) of the active humidification system (humidifier and patient circuit components) for their most recent recommendations regarding circuit configurations. Additionally, unless specifically contraindicated by these manufacturers' recommendations, we recommend the use of a drop-down tube and water collection vial (water trap) placed between the expiratory filter and the expiratory limb of the patient circuit. This is necessary to prevent damage to the expiratory filter. Reference P/N 1006241 Water Collection System, or equivalent.

CAUTION: Failure to protect the expiratory filter from damage by using inappropriate patient circuit configurations may cause damage to delicate ventilator components, such as the expiratory flow sensor, which may lead to inaccurate spirometry or a Vent Inop condition.

Connecting Additional Equipment

WARNING: Vent Inop is a serious condition, which is indicated by both visual and audible alarms. If the ventilator is attached to a patient when Vent Inop occurs, the patient must be supported with another means of life support ventilation.

When connecting a humidifier to the patient circuit, follow the setup procedure supplied by the humidifier manufacturer. The following steps should be followed to electrically connect the humidifier to the ventilator (for 100-120 VAC ventilators). For ventilators using voltage other than 100-120 VAC, the humidifier must be connected to another AC outlet.

1. Remove the cover of the humidifier AC power outlet on the back of the ventilator (Figure 6-3).

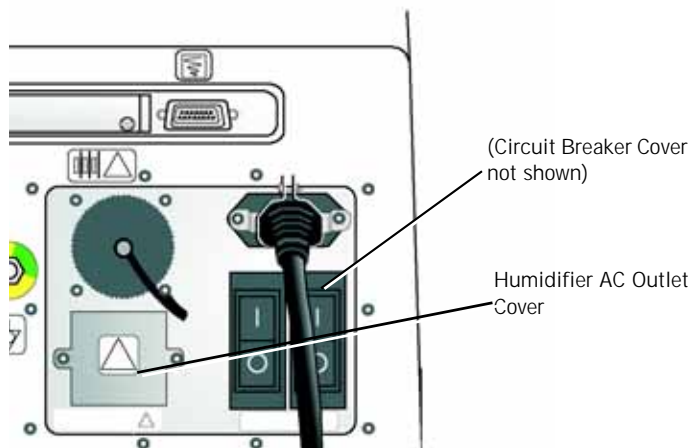

Figure 6-3: Humidifier AC Outlet Cover

2. Connect the humidifier AC plug to the humidifier AC power outlet.

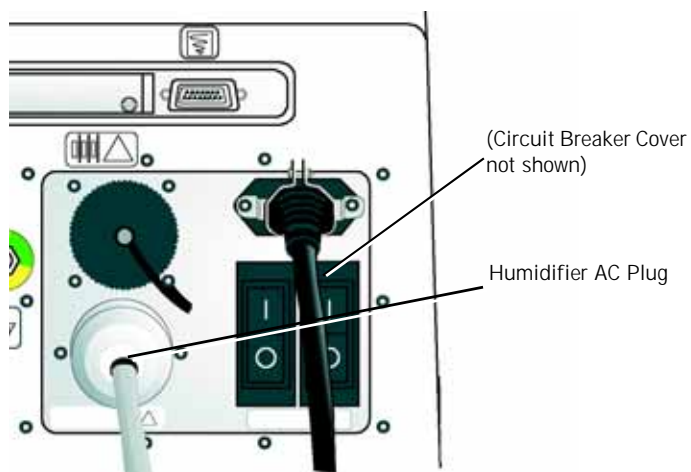

Figure 6-4: Humidifier AC Plug

3. Run any test procedures recommended by the humidifier manufacturer before the ventilator and humidifier are used on a patient.

WARNING: AC power is applied to the humidifier from the ventilator humidifier outlet (only available on 100-120 VAC ventilators). Under no circumstances does the Resprionics V200 Ventilator provide control for the humidifier. To ensure patient safety, it is important that any humidifier used with the ventilator include an acceptable temperature control and monitoring mechanism, as well as a temperature display and appropriate alarm capabilities (refer to ISO 8185).

Connecting the Patient Circuit

1. The humidifier should be connected between the inspiratory bacteria filter (Figure 6-5) and the inspiratory limb of the patient circuit that leads to the patient wye (Figure 6-6).
2. Follow steps illustrated by Figure 6-5, Figure 6-6, and Figure 6-7.



Figure 6-5: Ventilator Gas Outlet Port to Humidifier Patient Circuit Connection

Connecting Additional Equipment



Figure 6-6: Humidifier Outlet to Patient Wye Connection



Figure 6-7: Expiratory Limb of Patient Circuit to Water Trap Connection (Shows Down Tube between Ventilator and Water Trap)

Connecting Additional Equipment

When connecting a patient circuit without a humidifier (for example, when using a heat and moisture exchanger), refer to Figure 6-8.



Figure 6-8: Patient Circuit Connections Without Humidifier

Connecting the Analog Port

The analog output port adds a second remote alarm output. Pin 12 (fourth pin from the top left is pin 12) signals an unsilenced high or medium urgency alarm:

- 0 VDC = active alarm
- 1.5 VDC = no alarm or silenced alarm

Connecting Additional Equipment

The Communications option provides additional signals on this port. Refer to Chapter 13, "Options and Accessories".

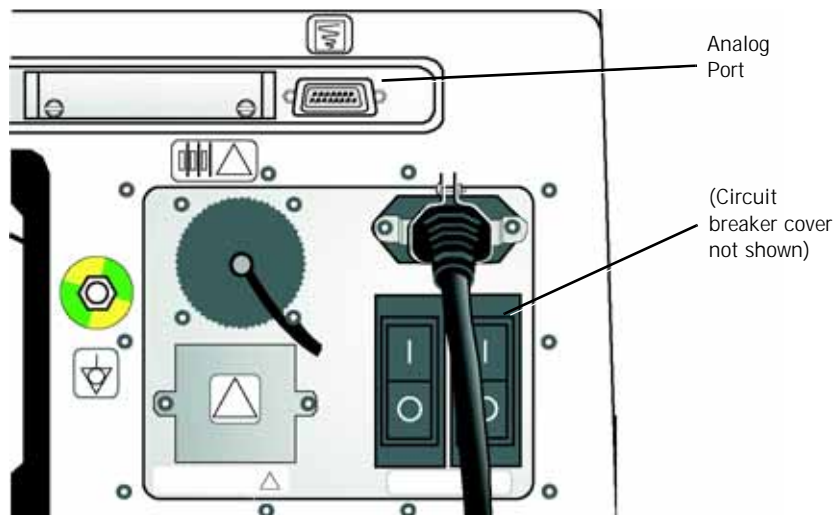

Figure 6-9: Analog Port

Chapter 7. Operating Theory

Introduction

This chapter describes the ventilator's breath delivery capabilities. It includes a system overview and descriptions of the ventilation modes and available breath types. For descriptions of button settings and general operating instructions, refer to Chapter 8, "Operating Instructions".

System Overview

The ventilator is a microprocessor-controlled ventilator capable of delivering a mixture of air and oxygen to a patient's lungs in a predetermined manner to augment or replace the work normally performed by the patient's respiratory system. The ventilator performs breath delivery via two different patient interfaces:

- endotracheal tube or tracheostomy tube (invasive ventilation)
- face mask, nasal mask, nasal pillows, or mouthpiece with a seal (non-invasive ventilation)

Ventilator Breath Types

The ventilator provides the following ventilation breath types:

- Volume Control Ventilation (VCV) – invasive ventilation
- Pressure Control Ventilation (PCV) – invasive ventilation
- Non-Invasive Positive Pressure Ventilation (NPPV) – non-invasive ventilation

During mechanical ventilation, the operator selects one of the ventilation modes. The selected ventilation breath type, along with the selected mode, the patient breathing effort, and the ventilator settings determine the type of breath delivered. Each ventilation breath type has its own settings, alarms, and monitor screens. (Refer to Chapter 8, "Operating Instructions".)

Volume Control Ventilation (VCV)

In Volume Control Ventilation, breaths may be controlled by the ventilator (mandatory) or triggered by the patient (spontaneous). When controlled by the ventilator, breaths will be flow controlled and time cycled, thus delivering an operator (TIDAL VOLUME) set volume. In Volume Control Ventilation, the flow pattern can be selected between square and descending ramp waveforms. Refer to Figure 7-1.

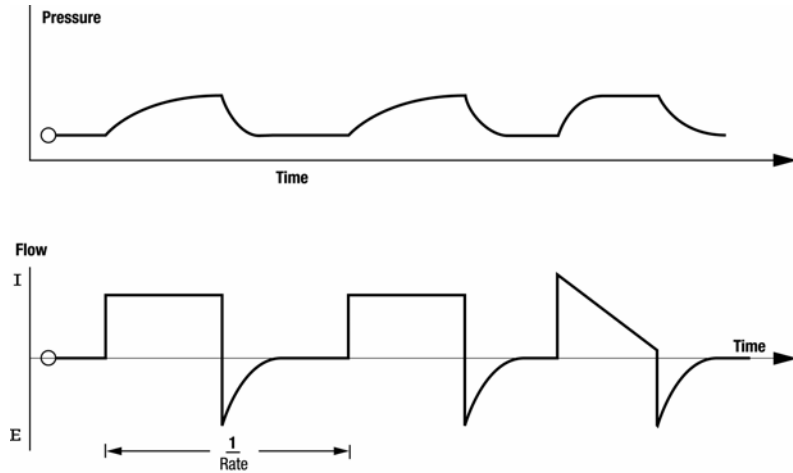

Figure 7-1: Volume Control Ventilation (VCV) Waveform

Pressure Control Ventilation (PCV)

In Pressure Control Ventilation, breaths may be controlled by the ventilator (mandatory) or by the patient (spontaneous). When controlled by the ventilator, breaths are pressure limited and time cycled, resulting in an operator set (PRESSURE) pressure being delivered for an operator set (I-TIME) period of time. Refer to Figure 7-2.

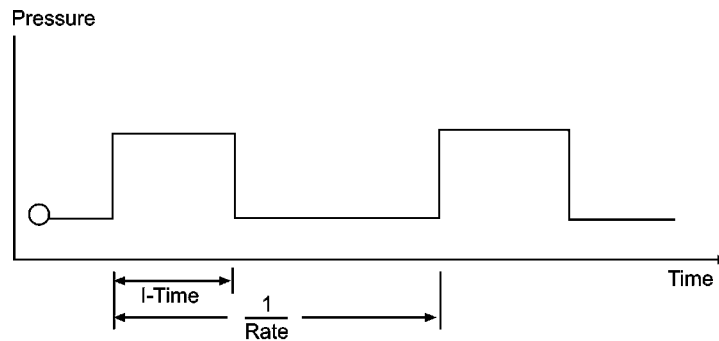

Figure 7-2: Pressure Control Ventilation (PCV) Waveform

Ventilation Modes Common to VCV and PCV

In Volume Control Ventilation and Pressure Control Ventilation, the operator can select between ventilation modes of Assist/Control, SIMV, and CPAP.

Assist Control Ventilation (A/C)

With the Assist/Control mode (refer to Figure 7-1 or Figure 7-2), a minimal rate and tidal volume (or inspiratory pressure) are set by the operator. The patient can trigger the ventilator at a more rapid rate, but the operator set tidal volume (or inspiratory pressure) is delivered during each breath. The ventilator delivers only mandatory breaths. Assisted breaths may be either pressure or flow triggered. If the trigger setting is adjusted so that the patient cannot trigger the ventilator, all breaths will be delivered by the ventilator at the operator set rate and tidal volume (or pressure).

Synchronized Intermittent Mandatory Ventilation (SIMV)

SIMV is a ventilation mode where the patient is allowed to breathe spontaneously and the machine attempts to deliver volume (VCV) or pressure (PCV) mandatory breaths in synchrony with the patient's effort at the operator set rate and volume (or pressure). This is accomplished by a combination of spontaneous and mandatory windows that open and close. The type of breath delivered depends upon whether the event during the window is patient initiated, operator initiated or time initiated. This logic is illustrated in Table 7-1: "SIMV Logic".

SIMV Logic			
Current SIMV State	Inputs	Ventilator Response	Next SIMV State
Mand Window	Time Trigger (breath period timer expires)	Deliver mandatory breath using operator settings for mandatory breath type; Restart breath period	Mand Window
Mand Window	Patient Trigger; Operator Trigger	Deliver mandatory breath using operator settings for mandatory breath type	Spont Window
Spont Window	Patient Trigger	Deliver a spontaneous breath using operator settings for spontaneous breath type	Spont Window
Spont Window	Operator Trigger	Deliver a mandatory breath using operator settings for mandatory breath type	Spont Window
Spont Window	Time Trigger (breath period elapses)	Restart breath period timer	Mand Window

Table 7-1: SIMV Logic

Continuous Positive Airway Pressure (CPAP)

CPAP is a spontaneous mode of ventilation. No mandatory breaths are delivered. Throughout the breath cycle, an operator set pressure is provided. The level of pressure delivered during CPAP is the baseline pressure, or PEEP (Positive end Expiratory Pressure). Refer to Figure 7-3.

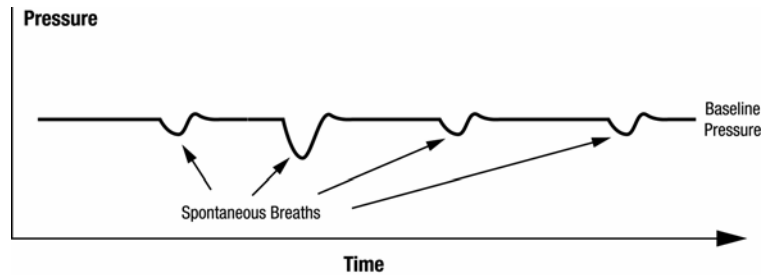

Figure 7-3: Continuous Positive Airway Pressure (CPAP)

Pressure Support Ventilation (PSV)

In Pressure Support Ventilation, the patient's spontaneous efforts are assisted by the ventilator at an operator set level of inspiratory pressure. Inspiration is initiated by the patient and terminated when the inspiratory flow falls below an operator set percentage of the peak flow during this breath. During Pressure Support, the patient determines the respiratory rate, and the patient and ventilator determine the inspiratory time and tidal volume. Refer to Figure 7-4.

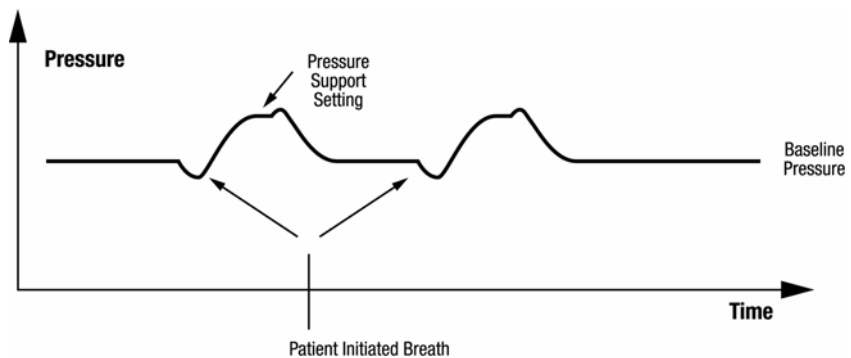

Figure 7-4: Pressure Support Ventilation (PSV)

Positive End Expiratory Pressure (PEEP)

The PEEP pressure is the operator set baseline pressure maintained during exhalation. All breaths are referenced to this baseline pressure and the resulting pressure is in addition to the baseline pressure. Refer to Figure 7-5.

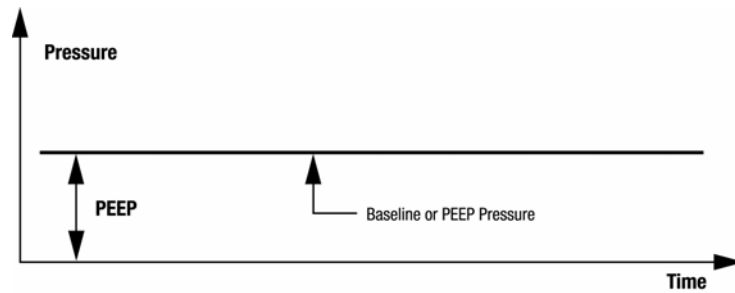

Figure 7-5: Positive End Expiratory Pressure (PEEP)

Rise Time Setting

Rise Time applies to all pressure targeted breaths — PSV, PCV, and IPAP in NPPV. The operator can adjust the velocity of pressurization to better match the patient's demand for flow. Refer to Figure 7-6.

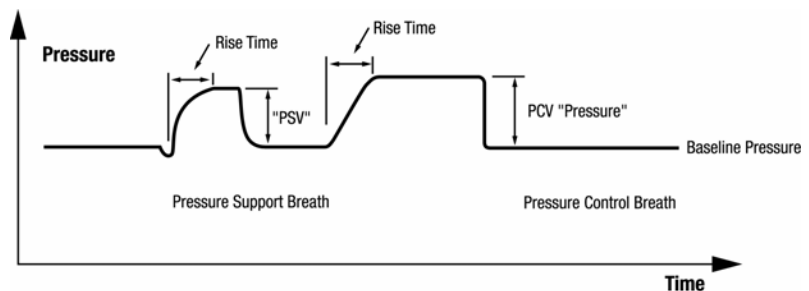

Figure 7-6: Rise Time

Patient Initiated Breath Triggering

Patient initiated breaths can be flow or pressure triggered in A/C, SIMV, CPAP for Pressure or Volume breath types, or flow triggered in NPPV. The pressure trigger level determines the amount of pressure below the baseline pressure that the patient must create in order for the ventilator to deliver a breath. The Flow Trigger level is the amount of flow that the patient must inspire from the base flow in order for the ventilator to deliver a breath.

Patient Leak Display

Estimated patient leak (Pt Leak) is displayed in LPM and updated at each breath. Pt Leak is the average leak rate during a breath (delivered volume minus exhaled volume divided by the breath time).

Pt Leak is estimated breath by breath. If the physical characteristics of the leak change, there will be a corresponding change in the actual leak flow, which will be detected and leak estimation will be updated in subsequent breaths. Physical characteristics of leaks are determined by a number of factors, for example, the size and shape of the leak (such as a gap in the seal between the mask and face). Leaks that may occur during invasive ventilation are usually undesirable and are not compensated to allow easier leak detection.

**Ventilation Modes
Common to NPPV****Non-Invasive Positive Pressure Ventilation (NPPV)**

In Non-Invasive Ventilation, gas is delivered to the patient via a nasal mask, full face mask, nasal pillows, or mouthpiece with a lip seal. The operator determines whether the mode is totally spontaneous (Spont Ventilation Mode) or spontaneous with a backup rate (Spont/T Ventilation Mode).

Spontaneous Ventilation Mode (Spont)

In Spontaneous Ventilation Mode, the operator sets the pressure during exhalation (EPAP) and the target pressure during inspiration (IPAP). The patient triggers the breath based on the Flow Trigger setting. Exhalation is determined by the setting E-Trigger, which is a percentage of peak flow during the breath. Refer to Figure 7-7.

Spontaneous/Timed Ventilation Mode (Spont/T)

In the Spontaneous/Timed Ventilation Mode, the patient can breathe spontaneously, or receive machined controlled breaths. The machine controlled breaths are delivered for a set inspiratory time at a set breath rate. In Spont/T mode, every patient initiated breath is spontaneous and restarts the breath period timer. If the patient triggers a breath before the breath period elapses, the ventilator delivers a spontaneous supported breath (based upon the settings). If the breath period elapses without a patient trigger, the ventilator delivers a ventilator initiated mandatory breath at the set IPAP level. Patient initiated, time cycled breaths are not delivered in Spont/T mode. Refer to Figure 7-7.

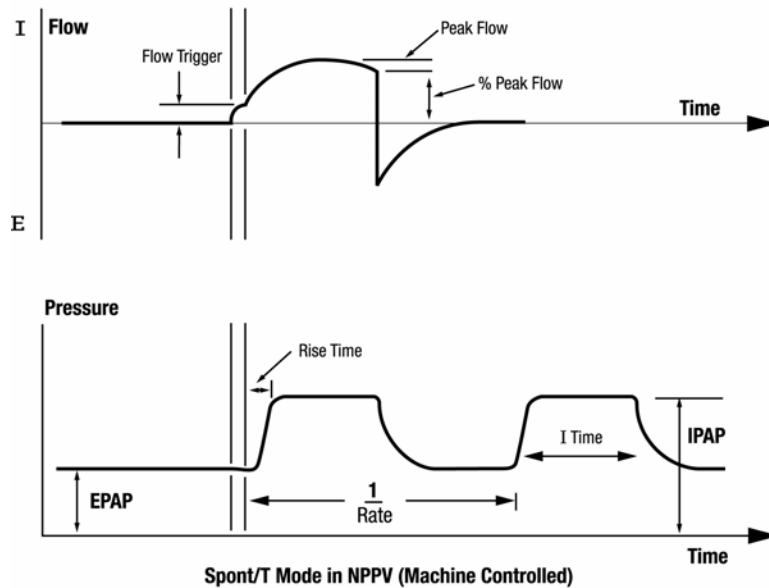

Figure 7-7: Spont/T Mode

Emergency Modes of Ventilation

The ventilator has the following two emergency modes of ventilation that are entered in response to certain alarm conditions:

- Apnea Ventilation
- Safety Valve Open

Apnea Ventilation

Apnea ventilation provides an emergency mode of ventilation if the ventilator does not deliver a breath for an operator set interval of time. The apnea time can be set between 10 and 60 seconds. Upon entering this mode of ventilation, the ventilator will alarm and immediately start using the Apnea Rate setting specified by the operator. In PCV and VCV, the ventilator will begin delivering breaths in Assist/Control (A/C), but with the operator set Apnea Rate. In NPPV, the ventilator will deliver only machine controlled breaths either at the operator set Apnea Rate or in response to patient effort. In Apnea ventilation, the alarms used are the ones used for machine controlled breaths for the ventilation breath type (VCV, PCV and NPPV) the ventilator was using when Apnea occurred.

Parameters Used in Apnea Ventilation, Settings, and Alarm Limits			
	VCV	PCV	NPPV
Settings	Tidal Volume	Inhalation Pressure	IPAP
	Peak Flow	Inhalation Time	EPAP
	PEEP	PEEP	Inhalation Time
	I-Trigger (pressure/flow)	I-Trigger (pressure/flow)	Rise Time
	Flow pattern	Rise Time	I-Trigger (flow)
	O ₂ %	O ₂ %	E-Cycle
	Insp Hold	Apnea Rate	O ₂ %
	Apnea Rate		Apnea Rate
Alarm Limits	High Pressure	High Pressure	Low Pressure
	Low Insp Pressure	Low Insp Pressure	Low EPAP
	Low PEEP	Low PEEP	Low Tidal Volume
	Low Mandatory Tidal Volume	Low Mandatory Tidal Volume	High Rate
	High Rate	High Rate	Low Exhaled Minute Volume
	High Exhaled Minute Volume	High Exhaled Minute Volume	High Leak
	Low Exhaled Minute Volume	Low Exhaled Minute Volume	

Table 7-2: Parameters Used in Apnea Ventilation, Settings, and Alarm Limits

The ventilator will reset out of Apnea Ventilation if the operator presses the Alarm Reset button, or if the patient triggers two successive breaths.

Safety Valve Open (SVO)

Safety valve open is an emergency mode of ventilation that allows the patient to breathe through the system whenever any of the following occur:

1. An occlusion is detected.
(The ventilator resumes normal breathe delivery if the occlusion is removed.)
2. Loss of both the air supply and the oxygen supply occurs.
(The ventilator resumes normal breath delivery if the gas supply is made available.)
3. The Ventilator Inoperative state (Vent InOp) is entered due to a hardware malfunction that prevents breath delivery.
(The ventilator will not resume normal breath delivery in this case. Call for service.)

During SVO:

1. The safety valve is opened,
2. The exhalation valve is opened,
3. The air and oxygen valves remain closed,
4. A high priority alarm is activated,
5. The Safety Valve Open indicator is illuminated,
6. The Normal indicator is turned off.

Chapter 8. Operating Instructions

Overview

-
- WARNING:** Ensure that an alternative means of ventilation (that is, a resuscitator or similar device) is available while the ventilator is in use on a patient.
- WARNING:** The ventilator complies with the requirements of IEC 601-1-2 (EMC collateral standard), including the E-field susceptibility requirements at a level of 10 volts per meter. However, even at this level of immunity, certain transmitting devices (cellular phones, walkie-talkies, etc.) emit radio frequencies that could disrupt ventilator operation if operated in a range too close to the ventilator.
- WARNING:** DO NOT operate the ventilator in a Magnetic Resonance Imaging (MRI) environment.
-

There are three ventilation breath types:

- Volume Control Ventilation (VCV)
- Pressure Control Ventilation (PCV)
- Non-Invasive Ventilation (NPPV)

Each has mandatory or machine controlled breaths and each has patient controlled or spontaneous breaths.

Each ventilation breath type has its own settings that are mutually exclusive from the other ventilation modes.¹

- In VCV, you can select either A/C, SIMV, or CPAP mode.
- In PCV, you can select either A/C, SIMV, or CPAP mode.
- In NPPV, you can select Spont/T or Spont mode.

Alarms are specific to the ventilation breath type. Alarm limits in one ventilation breath type are mutually exclusive from the alarm limits of the other ventilation breath types.

The ventilator is easy to use because all mode settings and alarm limits are selected using the same three-step process:

1. Select the parameter to be changed by pressing the associated button. The screen shown in Figure 8-1 appears.

1. Set O₂ and patient type are exceptions that can be changed only in the active mode and applies to all modes.

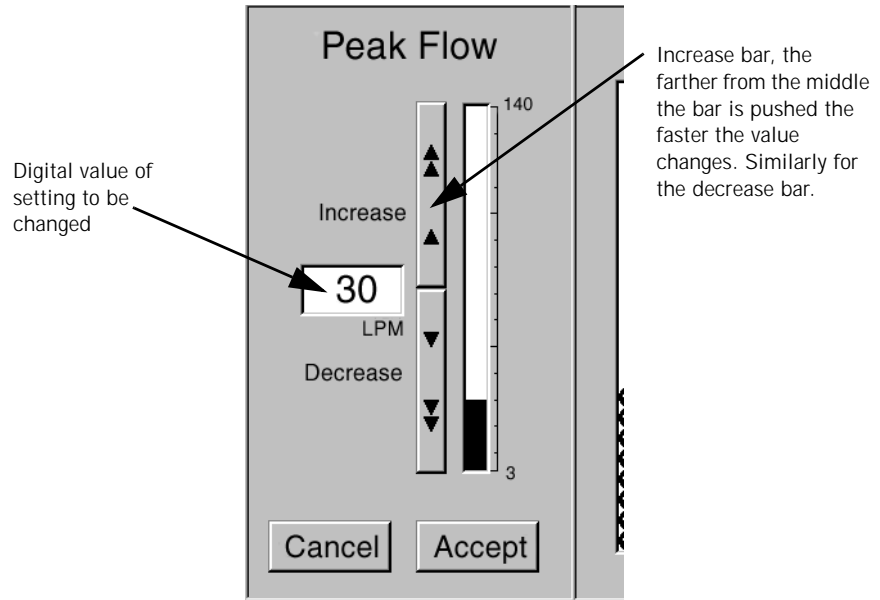

Figure 8-1: Entering Settings and Alarm Parameters

2. Press the INCREASE bar or DECREASE bar until the desired value appears in the digital window, or use the front panel control knob to increase or decrease the displayed value.
3. Press the ACCEPT button (or FRONT PANEL ACCEPT key) to enter the value and return to the previous display. Press the CANCEL button to leave the value unchanged.

NOTE: All volumes entered into the ventilator are assumed to be BTPS (Body Temperature atmospheric Pressure Saturated (with H₂O)) volumes unless otherwise noted. All volumes reported by the ventilator are reported as BTPS volumes. All pressures are assumed to be relative to atmospheric pressure unless otherwise noted.

The Front Panel

The text version of the ventilator's front panel includes the indicators and controls shown in Figure 8-2. The symbol version of the front panel is shown in Figure 8-3.

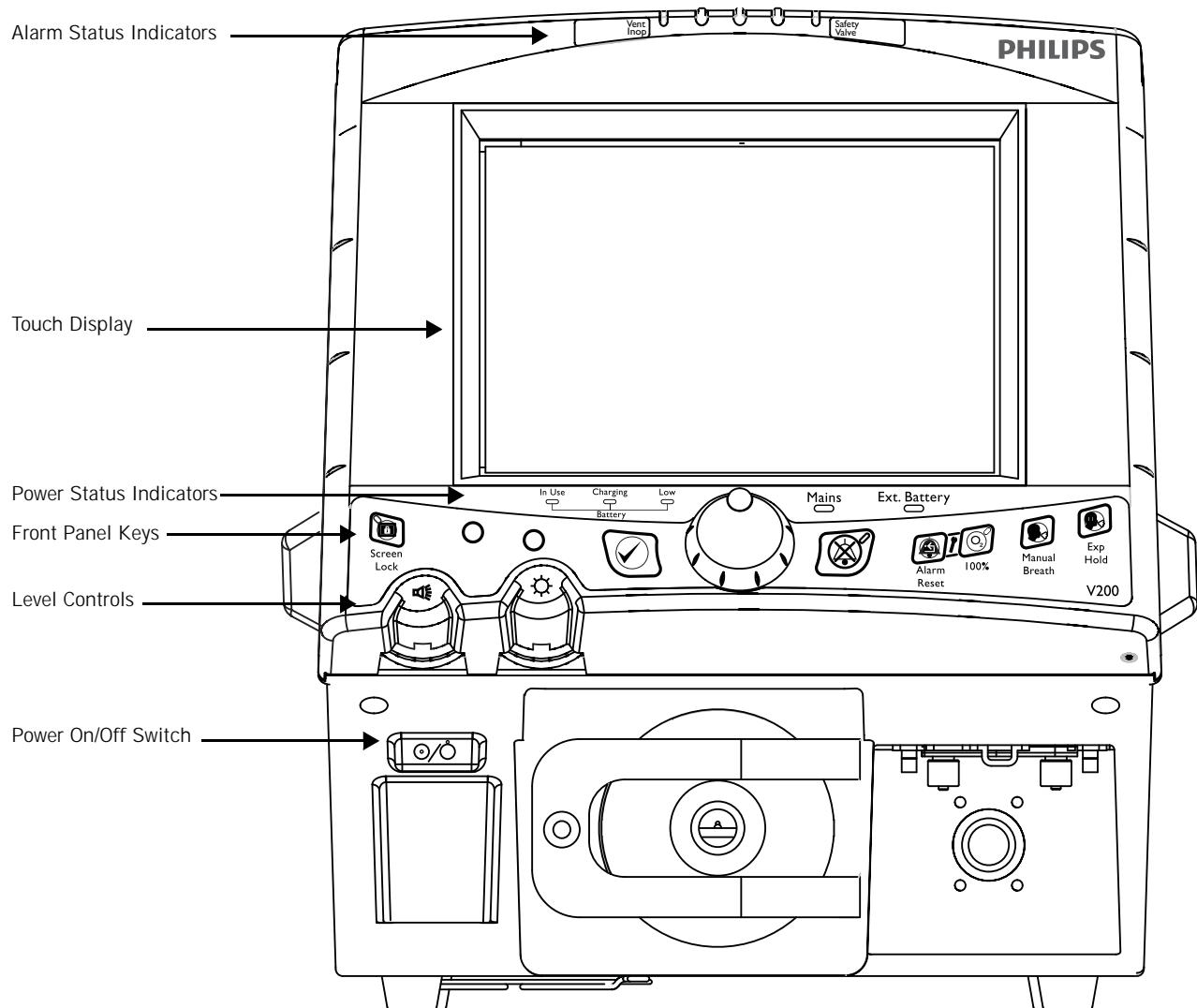

Figure 8-2: Front Panel — Text Version

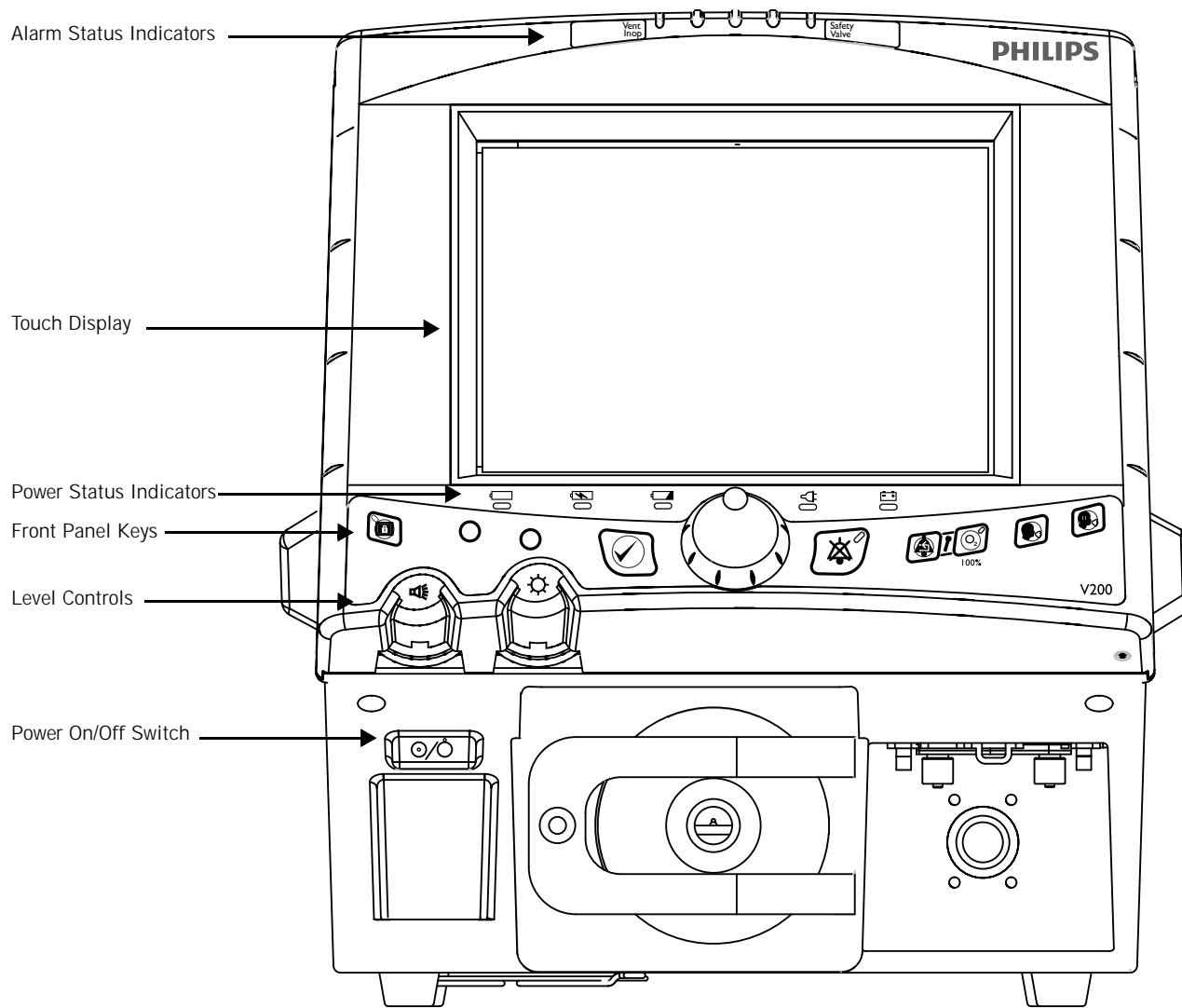

Figure 8-3: Front Panel — Symbol Version

Alarm Status Indicators

The alarm status indicators located at the top of the ventilator alert you to the ventilator's alarm conditions. (Refer to Chapter 9, "Alarms" for more detailed descriptions.)

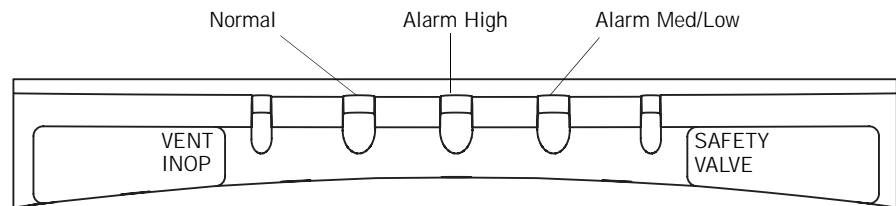

Figure 8-4: Alarm Status Indicators

Alarm Status Indicators		
Alarm Indicator	Status	Description
Normal	Green	No active or auto reset alarm condition exists.
High	Flashing red	A high priority alarm condition exists.
Med/Low	Flashing yellow	A medium priority alarm condition exists.
	Continuous yellow	A low priority alarm condition exists. In addition, indicates auto reset conditions
Vent Inop	Red (active)	The ventilator is not capable of supporting mechanical ventilation and requires service. During Vent Inop, the ventilator opens the safety valve to enable the patient to breathe room air spontaneously. The ventilator also discontinues detection of new alarm conditions during Vent Inop. WARNING: Vent Inop is a serious condition, which is indicated by both visual and audible alarms. If the ventilator is attached to a patient when Vent Inop occurs, the patient must be supported with another means of life support ventilation.
Safety Valve	Red (active)	The safety valve is open and the ventilator is not in operation. This is a high priority alarm condition. When the Safety Valve indicator is illuminated, the ventilator is not providing ventilatory support to the patient. The safety valve opens to allow the patient to breathe spontaneously through the ventilator circuit. The patient must be capable of creating a spontaneous breath in order to breathe through the safety valve.

Table 8-1: Alarm Status Indicators

Power Status Indicators

Power status indicators alert you to the status of the backup battery. The text version of the power status indicators is shown in Figure 8-5. The symbol version of the power status indicators is shown in Figure 8-6.

NOTE: The ventilator selects its power source based on the following prioritization: AC power (if present), external battery, then backup battery.

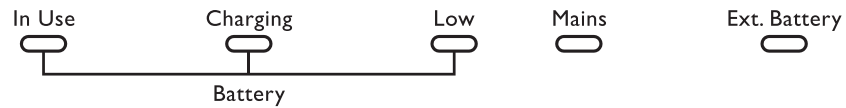

Figure 8-5: Power Status Indicators — Text Version



Figure 8-6: Power Status Indicators — Symbol Version



Power Status Indicators		
Battery Indicator	Status	Description
In Use 	Yellow (active)	The ventilator is running on backup battery power. The backup battery is used when there is no AC power and no other battery is available.
Charging 	Yellow (active)	The backup battery is charging. The battery should not be considered a fully charged power source when this indicator is illuminated. The Charging indicator will stay on for the duration of the charging cycle, which can last up to ten hours. Once the battery has fully charged, the Charging indicator will turn off.
Low 	Flashing red	The backup battery has approximately 5 minutes of power remaining. WARNING: When the battery low indicator is flashing red, operation of the ventilator from battery power should be discontinued.

Table 8-2: Power Status Indicators (Sheet 1 of 2)



Power Status Indicators (Continued)		
Battery Indicator	Status	Description
Mains 	Green	The ventilator is connected to an AC power source and the rear panel Mains circuit breaker is on (I).
Ext. Battery 	Yellow	Continuously illuminated when the external battery is in use. NOTE: The external battery is an optional accessory. See "Options and Accessories" on page 13-1 for more information.

Table 8-2: Power Status Indicators (Sheet 2 of 2)

Front Panel Keys

The front panel keys enable you to initiate ventilator functions. The keys that include an indicator (🔘) also provide operational status of the function that it performs. The text version of the front panel keys is shown in Figure 8-7. The symbol version of the front panel keys is shown in Figure 8-8. (Refer to Chapter 9, “Alarms” for more detailed information on the alarm keys and buttons).

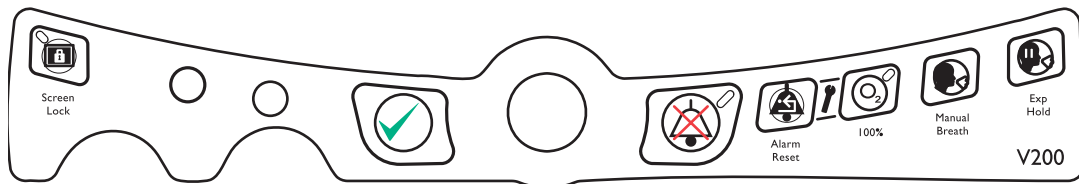

Figure 8-7: Front Panel Keys — Text Version

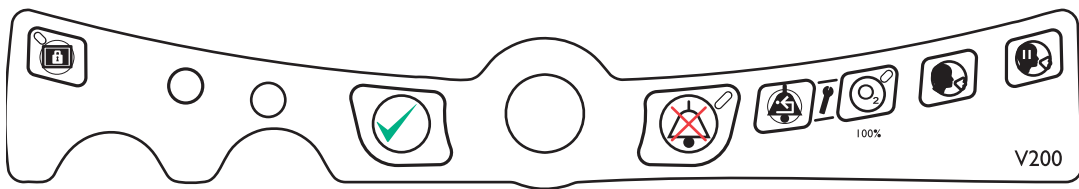

Figure 8-8: Front Panel Keys — Symbol Version

Front Panel Keys		
Key Symbol	Definition	Description
	Screen Lock	<p>Function: Locks and unlocks the graphic display (touch screen). When the screen lock is activated, all on-screen buttons are disabled until the touch screen is unlocked. This prevents inadvertent setting and display changes via the touch screen. MANUAL BREATH, 100% O₂, EXP. HOLD, ALARM RESET, and ALARM SILENCE keys are still active keys.</p> <p>Indicator: Illuminates green when active.</p>
	Accept	<p>Function: Enables you to accept selected settings on the front panel graphical display.</p>

Table 8-3: Front Panel Keys (Sheet 1 of 3)



Front Panel Keys (Continued)		
Key Symbol	Definition	Description
	Alarm Silence	<p>Function: Disables the audio alarm for two minutes. When Alarm Silence is pressed before the end of a two-minute period, the two-minute timer is reset. Alarms that cannot be silenced are listed in Table 9-1: "Alarm Alert Messages" on page 9-5.</p> <p>Indicator: Illuminated yellow when the audible alarm has been disabled; is active and stays on for two minutes when the ALARM SILENCE button is pressed. If ALARM SILENCE is active, and a new alarm condition occurs, which involves exceeding an active alarm limit, the visual alarm functions will be active. (Refer to "Alarm Silence" on page 9-2.) ALARM RESET clears ALARM SILENCE. If a medium or high priority alarm exists after ALARM RESET clears ALARM SILENCE, the audible alarm will begin.</p>
	Alarm Reset	<p>Function: Clears the visual indicator for auto reset alarms, certain active alarms (see "Alarm Reset" on page 9-3), and reset of apnea ventilation back to the active mode of ventilation (see "Apnea Ventilation" on page 8-27). Alarm Reset also terminates ALARM SILENCE.</p> <p>NOTE: The ventilator may automatically reset certain types of alarm conditions once the causes of the alarms are corrected. After an automatic reset, the ventilator will clear the audible alarm and will display a Low Urgency Alarm alert in the Alert Message Insert to inform the operator that an alarm condition existed. When this situation occurs, use ALARM RESET to clear the visual alarm indicator.</p>
	100% O ₂	<p>Function: Press once to deliver 100% O₂ to the patient for two minutes. Subsequent button presses will reset the timer to two minutes.</p> <p>NOTE: If the 100% O₂ key is pressed and a 100% O₂ gas source is not available, the Low O₂ alarm will be active for the two-minute 100% O₂ delivery period.</p> <p>Indicator: Illuminated green; is active only when the 100% O₂ front panel button has been pressed and the ventilator is delivering 100% O₂ to the patient; remains on for the duration of 100% O₂ delivery (two minutes).</p> <p>NOTE: If the operator sets the %O₂ setting to 100%, the 100% O₂ indicator does not light. The 100% O₂ indicator only lights when the 100% O₂ front panel key has been pressed..</p>

Table 8-3: Front Panel Keys (Sheet 2 of 3)



Front Panel Keys (Continued)		
Key Symbol	Definition	Description
	Manual Breath	<p>Function: Delivers an operator-initiated, mandatory (OIM) breath. Delivery of the breath is based on the current ventilation breath type settings.</p> <p>NOTE: Manual breaths are not permitted during the inspiratory phase of a breath (whether manual or spontaneous). Pressing the MANUAL BREATH key during these times will not result in the delivery of a manual breath.</p>
	Expiratory Hold	Enables calculations of Auto-PEEP from an expiratory hold maneuver. (See "Special Procedures" on page 8-31.)

Table 8-3: Front Panel Keys (Sheet 3 of 3)

Front Panel Level Controls

The front panel level controls enable you to adjust ventilator settings, brightness, and volume.





Front Panel Controls		
Control	Definition	Description
	Adjust Control	Used in conjunction with the front panel graphical display and touch screen to enter operator-selected values for ventilator settings and alarms.
	Display Brightness	Increases or decreases the brightness of the touch screen display
	Audible Alarm Volume	Increases or decreases the audible alarm volume. The minimum audible alarm volume is dictated by international standards. The audible alarm volume control will not turn the audible alarm volume lower than the minimum decibel level dictated by these standards. It is not possible to turn the audible alarm volume off.
	On/Off Switch	Located near the front panel, the On/Off switch is recessed to avoid inadvertent or accidental access. When the switch is in off (⊙) position, the ventilator does not provide mechanical ventilation, although AC power is active and the green Mains indicator is illuminated.

Table 8-4: Front Panel Controls

Ventilator Screens

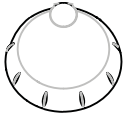
Front Panel Touch Display

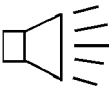
The front panel display allows you to select ventilation modes, breath types, settings, alarms, and access patient data. The front panel display is a touch screen that lets you select settings and data so you can monitor the status of the patient, ventilator, and control ventilator operation.

There are two different categories of screens:

- Ventilator Screens that appear when the machine is functioning as a ventilator
- Diagnostic Screens that appear when the machine is not functioning as a ventilator and is running internal tests

(Refer to Chapter 11, "Diagnostics", for more information about displaying ventilator diagnostic information.)

Common Ventilator Screen Components

Except for the patient data screen, screen configurations are determined by the selected ventilation breath type. Figure 8-9 shows the elements that are common to all ventilator (non-diagnostic) screens: the top bar, bottom bar, and manometer.

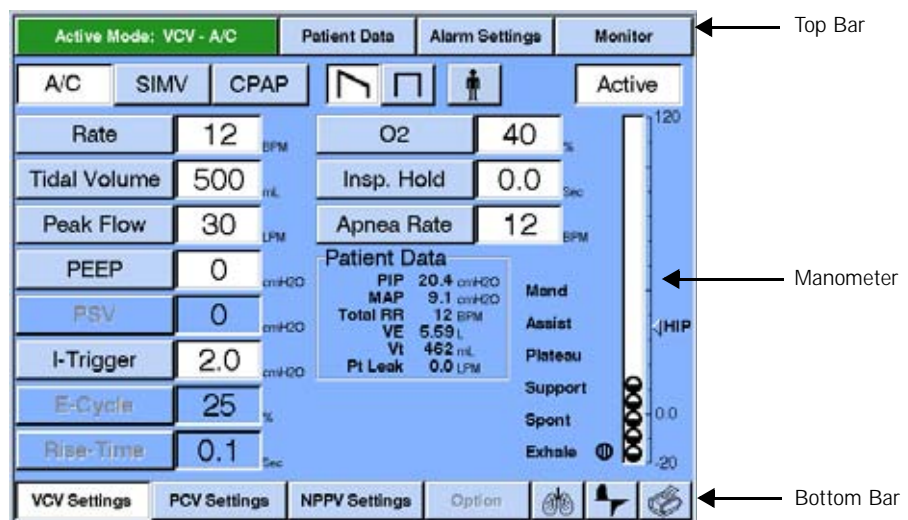

Figure 8-9: Elements Common to All Operational Screens (VCV settings shown)

Operating Instructions

Figure 8-10 shows the top bar and describes its buttons.

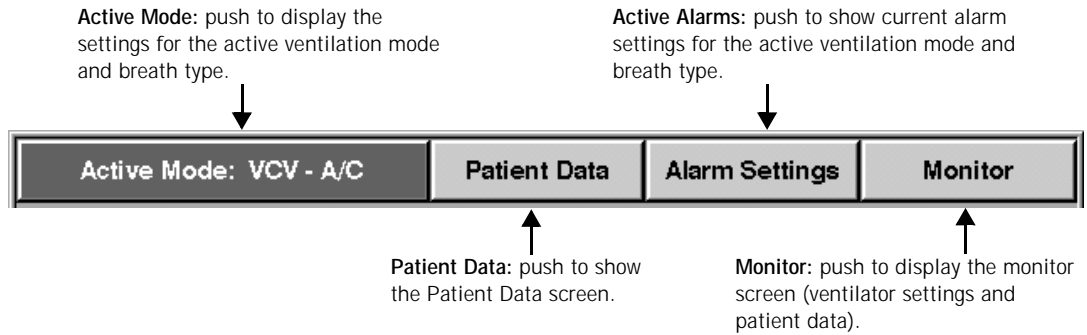

Figure 8-10: Top Bar (common to all operational screens)

Figure 8-11 shows the bottom bar and describes its buttons.

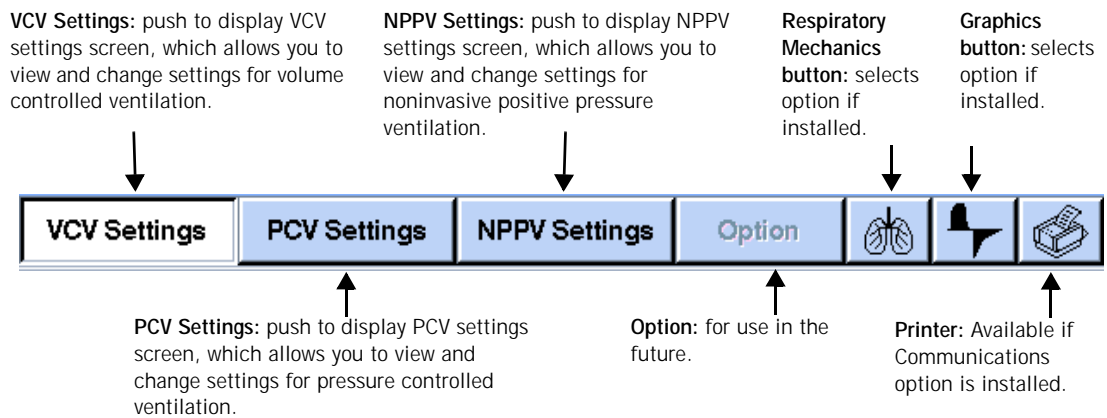

Figure 8-11: Bottom Bar (common to all operational screens)

Buttons in the bottom bar have two states, "selected" and "not selected". In the "selected" state, the button has a white background and black letters (see VCV SETTINGS in Figure 8-11). In the "not-selected" state the button has a gray background and black letters (see PCV SETTINGS, and NPPV SETTINGS in Figure 8-11). In the upper bar the buttons PATIENT DATA, ALARM SETTINGS, and MONITOR are also the "selected/not-selected" type.

When one of these "selected/not-selected" buttons is selected, it indicates that the screen is being used to display the information described by the name of the button on the screen. Making a setting screen "selected" (for a breath type that is not active), is the first step to activate that ventilation breath type (Refer to "Selecting a New Ventilation Breath Type (VCV, PCV, or NPPV)" on page 8-23.)

Figure 8-12 shows the real time manometer displays.

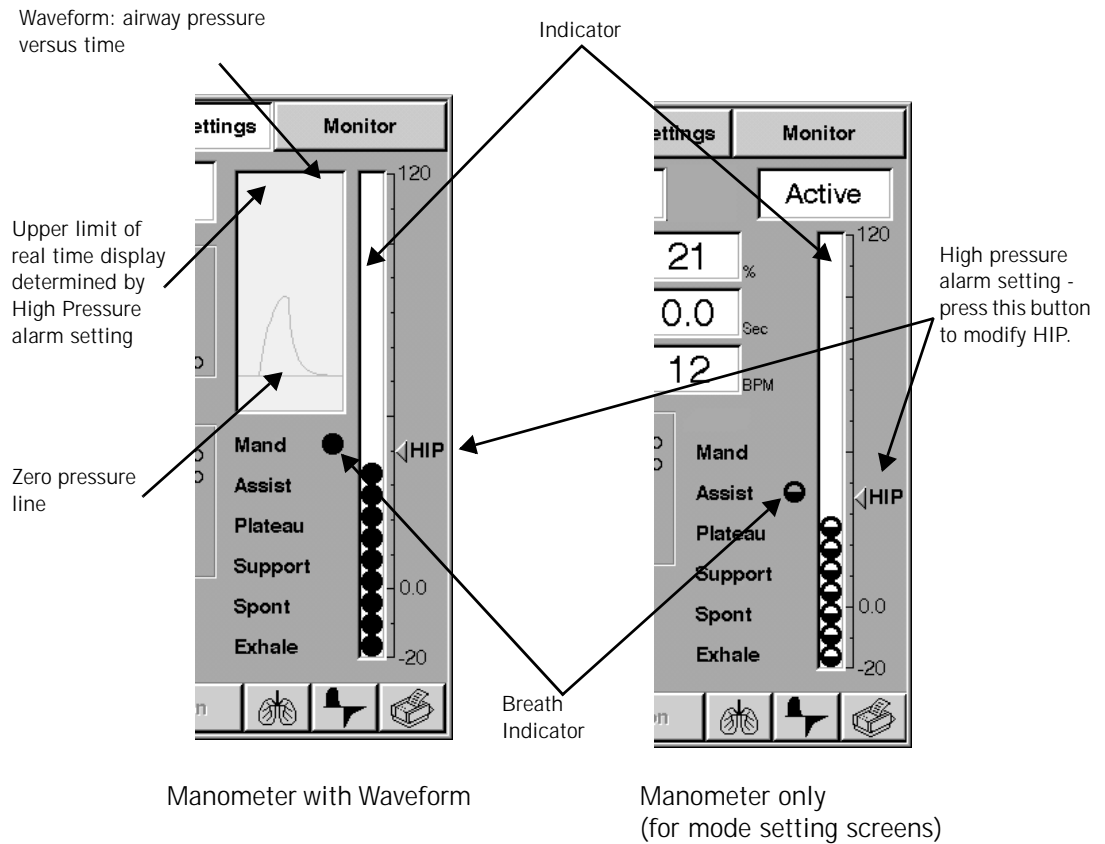

Figure 8-12: Manometer (common to operational screens)

Table 8-5: "Breath Indicator" describes the breath indicator.

Breath Indicator		
Breath	Symbol	Description
Mand	●	Operator or ventilator triggered mandatory breath.
Assist	◐	Patient triggered mandatory breath.
Plateau	●	Inspiratory hold, can be set at the end of the inspiratory phase of a VCV breath type.
Support	◐	Patient triggered spontaneous breath with PSV>0 or IPAP>EPAP.
Spont	○	Patient triggered spontaneous breath, PSV=0 or IPAP = EPAP.
Exhale	⊘	Indicates exhalation phase of any breath.

Table 8-5: Breath Indicator

◀ **HIP** Pressing the HIP indicator on the screen (Figure 8-12) will immediately allow the operator to modify the high pressure limit for VCV or PCV. In NPPV, the high pressure limit is automatically set to 10 cmH₂O (hPa) above IPAP. The HIP indicator does not appear near the manometer in NPPV.

Settings Screens

The buttons in the middle of the settings and alarm limit screens all have two states: active and inactive. Active settings have a gray background with black letters (Figure 8-13). An active setting is currently being used to control ventilation or as an alarm limit. Inactive setting buttons have a gray background with gray letters. Inactive settings are not currently being used to control ventilation or as an alarm limit. In both states the button can be pressed and an insert window will appear that will allow the operator to change the value of the setting (Figure 8-1).

NOTE: Some settings buttons appear active despite the fact they are not being used in the ACTIVE MODE. This is because the setting is used in Apnea Ventilation or when manual inspiration is pressed. The operator should always choose a value for an active button that is appropriate for the patient being ventilated..

Pressing the ACTIVE MODE button displays the settings screen for the currently selected ventilation breath type and mode (Chapter 7, “Operating Theory”, for more information on ventilation modes, breath types, and controls).

For example, in Figure 8-13 the current breath type is VCV and the mode is A/C. Because A/C does not allow the ventilator to deliver any spontaneous breaths, any settings that apply to spontaneous breaths are not active and are grayed out. In Figure 8-13, PSV is grayed out, indicating that it isn't active, but you can still push this button and change the PSV value. The PSV value will become active only if the SIMV or CPAP mode is selected.

Ventilation mode: A/C, SIMV, or CPAP. Spont or Spont/T are available during NPPV

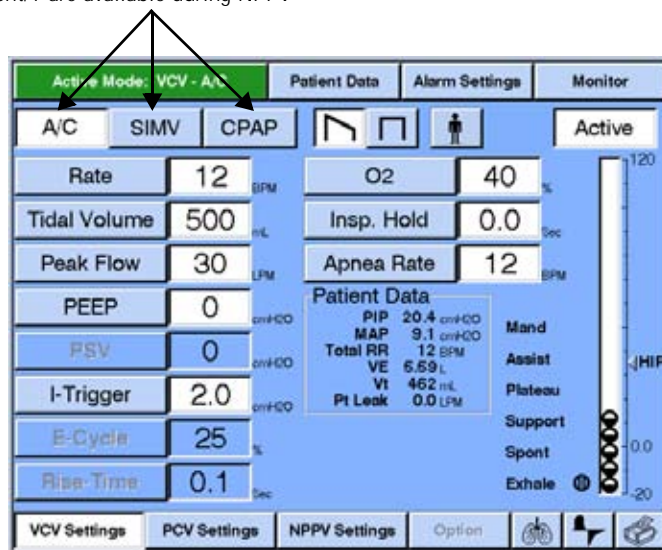

Ventilation control settings: VCV, PCV, or NPPV

Figure 8-13: VCV Settings Screen (VCV active)

Selecting Settings

Follow these steps to adjust ventilator control settings:

1. Push VCV SETTINGS, PCV SETTINGS, or NPPV SETTINGS.
2. Push the button for the control settings you want to select. The ventilator displays the current value for that parameter in an insert that allows the operator to adjust the settings value. (Figure 8-14).
3. Press the bar to increase or decrease the setting to the value you want or use the front panel knob to adjust the value of the setting.
4. Press the screen ACCEPT button or the front panel ACCEPT button to activate the new setting or CANCEL to leave the setting unchanged.

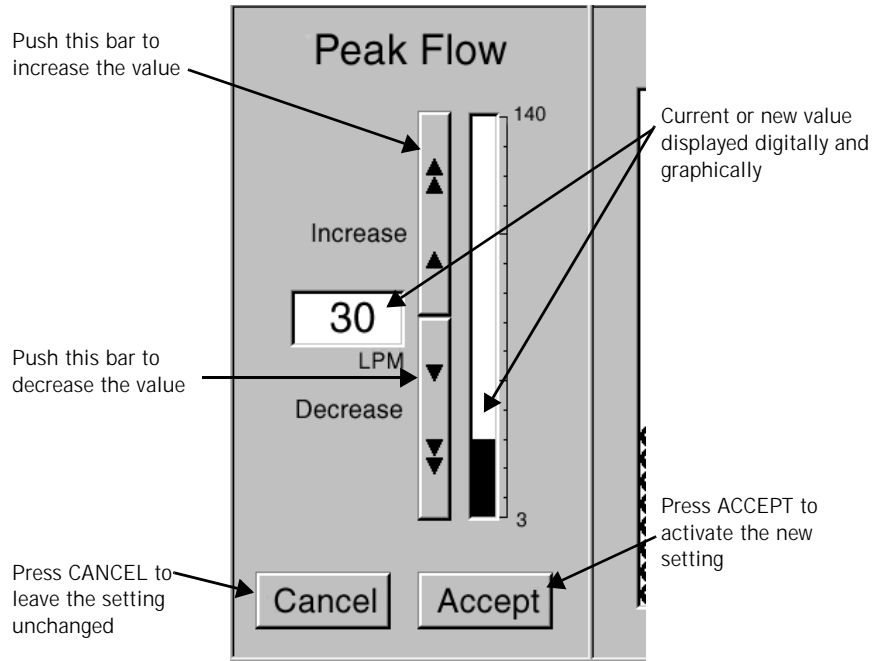

Figure 8-14: Changing a Setting

When a value is entered, as shown in Figure 8-14, the ventilator checks to assure that the value has been accepted by the operator, is within limits, and will not cause other settings to be out of limits. If the new value causes these limits to be exceeded, a diagnostic message will be displayed. (Refer to "Value Entry Message" on page 12-4 for more details about the diagnostic messages).

Selecting Alarm Limits

Follow these steps to adjust currently active alarm limits:

1. Push ALARM SETTINGS. The ventilator displays the alarm limits for the currently active ventilation mode (Figure 8-15).
2. Push the button for the alarm limit you want to adjust. The ventilator displays the current value for that alarm limit in a display insert, similar to Figure 8-14.
3. Press the bar or use the front panel knob to adjust the value.
4. Press ACCEPT to activate the new alarm limit or CANCEL to leave it unchanged.

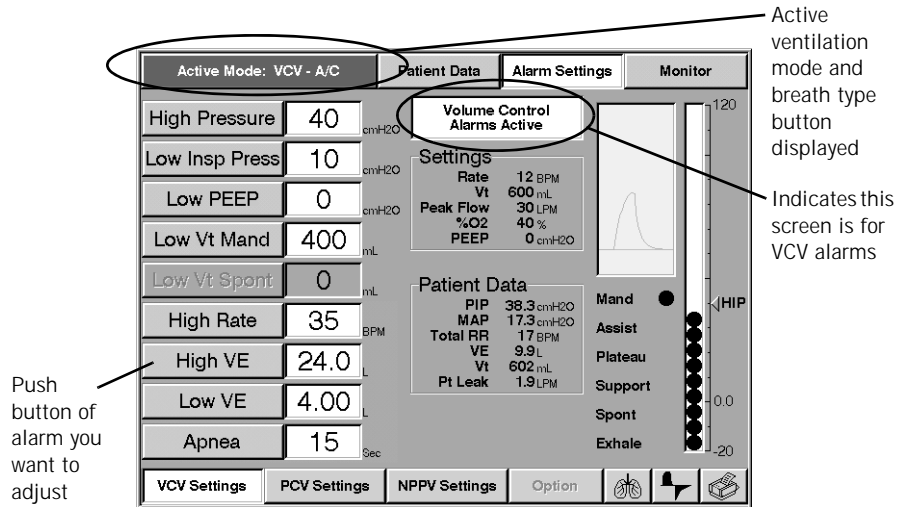

Figure 8-15: Setting Alarm Limits That Are Currently Active

The High Pressure Alarm Setting may be accessed through the Alarms Settings Screen or through the HIP Indicator adjacent to the manometer in the PCV and VCV Settings, Alarm Settings, Patient Data, and Monitor Screens.

-
- WARNING:** For patient safety the HIP Limit Setting should be set as close to the peak inspiratory pressure as patient conditions allow.
- CAUTION:** If clinical conditions do not require setting the HIP Limit above 60 cmH₂O, we recommend the setting normally be adjusted to 60 cmH₂O or less in order to prolong the operating life of the blower and to maximize backup battery run time.
- NOTE:** When the active mode is set to NPPV, the HIP Limit Setting will automatically be adjusted to 10 cmH₂O above the current IPAP setting.
-

Follow these steps to adjust alarm limits that are not currently active:

1. Depending on the alarm limits you wish to review, push the VCV SETTINGS, PCV SETTINGS, or NPPV SETTINGS button that has a gray background and black letters (not active).

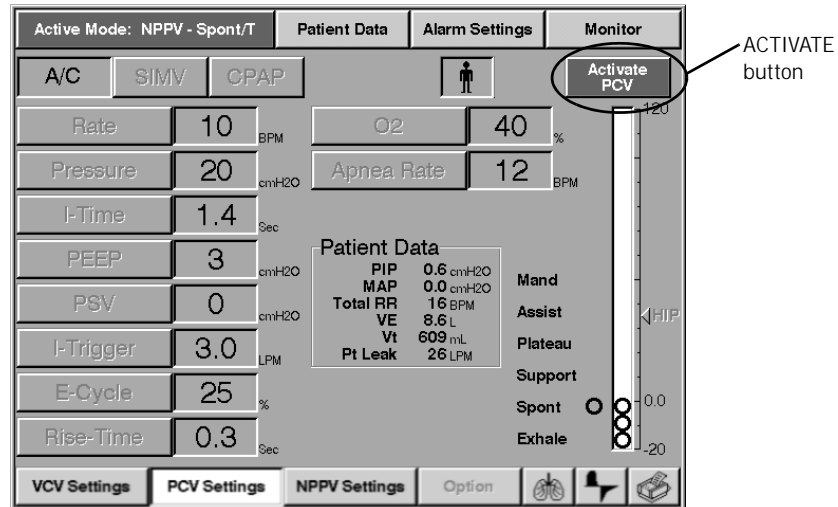

Figure 8-16: PCV Setting while NPPV is the active breath type

- From the control settings screen, push the ACTIVATE button. Refer to Figure 8-16. The ventilator displays a prompt insert (Figure 8-17).

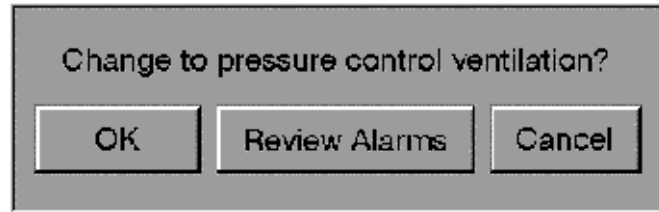

Figure 8-17: Change Breath Type Insert Window for PCV

- Select the REVIEW ALARMS button to display the alarm settings for PCV (Figure 8-18).
- Notice that all the alarm buttons (Figure 8-18) are grayed out, indicating that the alarm limits are not currently active. The ventilator displays the current value for that set of alarm limits. Push the button for the alarm limit you want to adjust.

NOTE: The ventilator keeps a distinct set of alarm limits for each ventilation breath type (VCV, PCV and NPPV).

- Press the bar or use the front panel knob to adjust the value (as shown in Figure 8-14).
- Press ACCEPT to activate the new alarm limit or CANCEL to leave it unchanged.

Grayed out buttons indicate that the alarm limits are not active

Push button of alarm setting to adjust

Press this ACTIVATE button to switch to the ventilation breath type indicated. The ventilation breath type on this button indicates which alarm set is shown on this

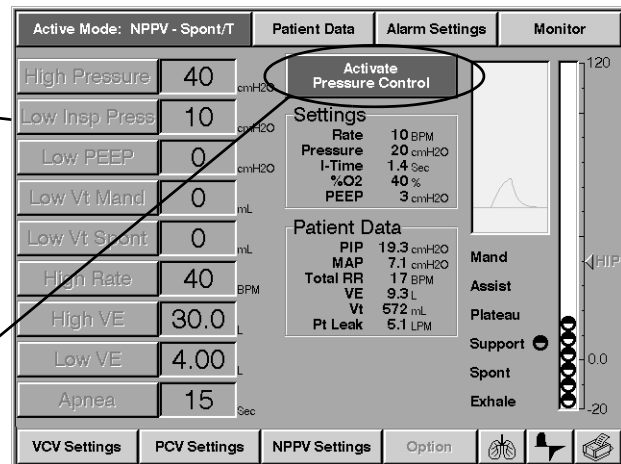

Figure 8-18: Setting Alarm Limits That Are Not Currently Active

NOTE: Any of the changes made in the screen shown in Figure 8-18, do not take effect until the operator switches to the new ventilation breath type (in this case Pressure Control).

Selecting Waveforms (VCV only)

Two inspiratory flow waveforms for mandatory VCV breaths are available: descending ramp and square wave (Figure 8-19). The selected waveform is highlighted and defines the inspiratory flow for all mandatory VCV breaths, whether they are initiated by the patient, the ventilator, or the operator. The waveform selection is not applicable to PCV or NPPV.

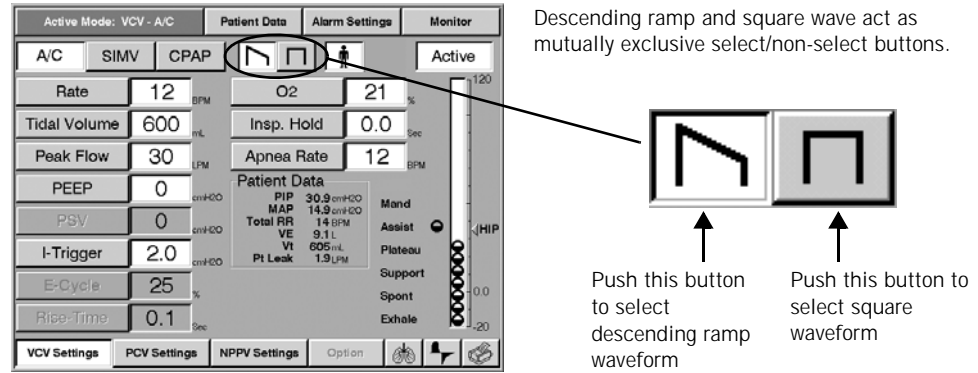

Figure 8-19: Selecting Waveforms (descending ramp selected)

Selecting Adult/Pediatric Buttons

You can configure ventilation for adult or pediatric patients (Figure 8-20) from the active ventilation type screen. Selecting adult or pediatric tailors the ventilator's breath delivery algorithms to the selected adult/pediatric patient type. Selecting adult or pediatric does not change how the screens work, and does not change ventilator or alarm settings. The patient type selection determines flow output at various rise time settings for PCV, PSV, and IPAP. In addition, the "I-Time too long" alarms and time out for spontaneous breaths are set to 3.5 seconds for the adult setting and 2.5 seconds for the pediatric setting. Peak flow is limited to 100 LPM in all pressure-based breaths when using the pediatric setting.

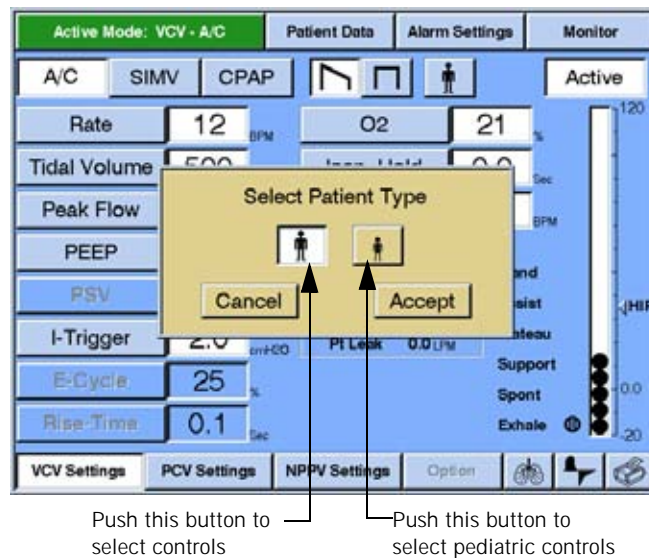

Figure 8-20: Selecting Adult/Pediatric Controls (adult selected)

Selecting the Inspiratory Trigger (I-Trigger)

The I-Trigger setting determines how inspiratory effort is detected (by measuring a drop in airway pressure or an increase in patient inspiratory flow) and when inspiration begins.

- In VCV and PCV, you can select a pressure or flow I-Trigger.
- In NPPV, the I-Trigger is always Flow.

Follow these steps to set the I-Trigger:

1. Push the VCV SETTINGS, PCV SETTINGS, or NPPV SETTINGS button.
2. Push the I-TRIGGER button. The inspiratory trigger window insert (Figure 8-21) appears.
3. In VCV and PCV: select Pressure or Flow. (Because only the flow trigger is available in NPPV, the Pressure and Flow buttons do not appear in this insert in NPPV.)
4. Adjust and change the value as described above.

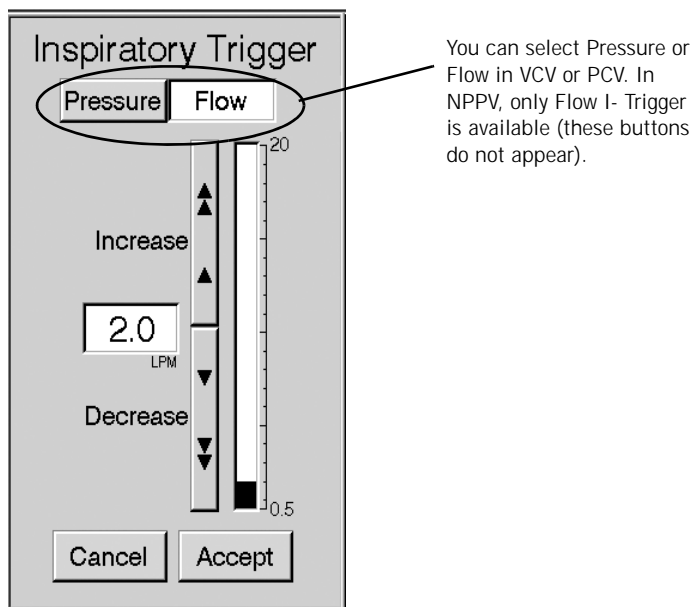

Figure 8-21: Inspiratory Trigger Window

Settings with Calculated Values

Certain window inserts that are used to modify values of settings can also have calculated results in them (Figure 8-22).

When the settings window insert being displayed is VCV Rate, the calculated minute volume that results from the rate and tidal volume settings is displayed along with the rate value. This is also the case when the tidal volume setting window insert is displayed. When the setting window insert for PCV Rate is

displayed, the calculated value for the I:E ratio that will result from the PCV rate value is also displayed.

When the setting window insert for VCV Apnea Rate is displayed, the calculated minute ventilation that will exist if the ventilator goes into Apnea Ventilation in VCV is shown. When the setting window insert for PCV Apnea Rate is displayed, the I:E Ratio shown is the I:E Ratio that will exist if the ventilator goes into Apnea Ventilation in PCV.

PCV Settings Window Insert

VCV Settings Window Insert

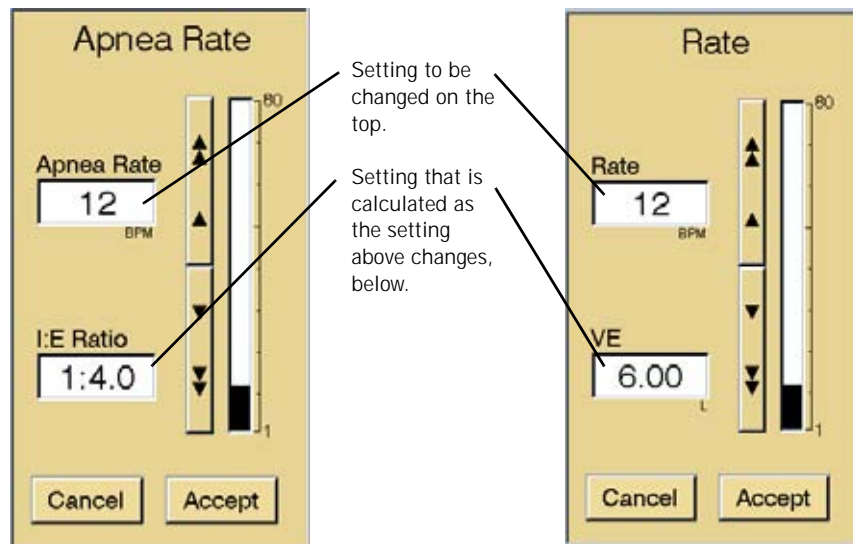

I:E Ratio is the parameter that is calculated and displayed in certain PCV setting window inserts. These are PCV Rate, PCV I-Time, and PCV

VE is the parameter that is calculated and displayed in certain VCV setting window inserts. These

Figure 8-22: Settings Window Inserts With Calculated Results

Rate and Apnea Rate Settings Relationship

For all breath types, VCV, PCV, and NPPV, the ventilator ensures the Apnea Rate setting is equal to or greater than the set Rate up to 20 BPM. When set rate is equal to the Apnea Rate and less than 20 BPM increasing the Set Rate increases the Apnea Rate equally up to 20 BPM. Above 20 BPM the Apnea Rate can be greater than or less than the Set Rate, down to 20 BPM.

Changing IPAP or EPAP in NPPV

When changing the IPAP or EPAP settings in NPPV, the difference between IPAP and EPAP is displayed in the window insert as PSV.

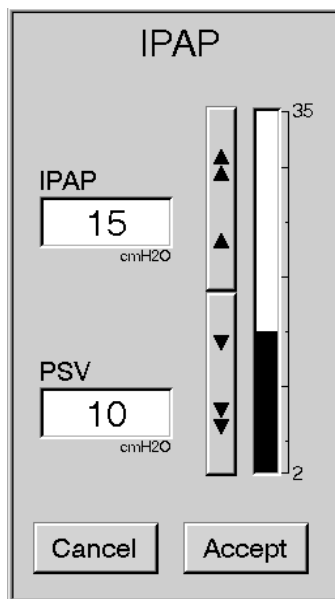

Figure 8-23: Changing IPAP or EPAP in NPPV

Selecting a New Ventilation Breath Type (VCV, PCV, or NPPV)

Follow these steps to select the ventilation breath type:

1. Press the button for the new breath type you want to select from the bottom bar (Figure 8-24) [PCV in this example].



Figure 8-24: Ventilation Control Buttons (PCV settings selected)

2. The setting screen for the selected breath type appears. All of the settings are grayed out, indicating that they are not currently active. However, you can use the grayed out buttons to change the settings as necessary, (with the exception of Set O₂ and patient type, which can be changed only in the active mode).

For example, if you press PCV SETTINGS when the current breath type is NPPV, all the PCV settings are grayed out (Figure 8-25) because NPPV is currently active.

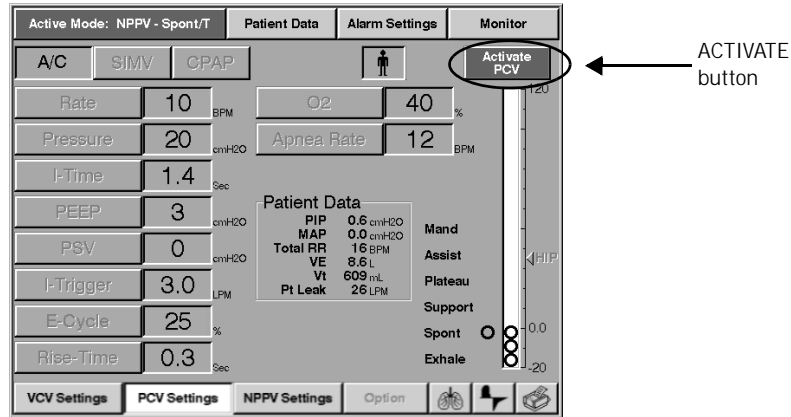

Figure 8-25: Settings Screen (PCV settings, PCV not currently active)

3. Press the ACTIVATE button. The prompt in Figure 8-26 is displayed on the screen.

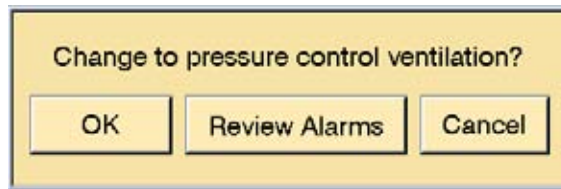
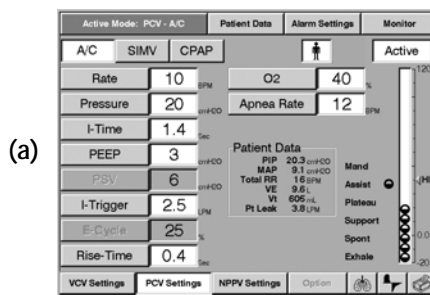

Figure 8-26: Prompt when Activate is pressed and PCV settings selected

4. At this prompt the operator can:
 - Move directly into PCV by pressing the OK button, or
 - Review the PCV alarm settings, or
 - Change nothing and return to the PCV settings screen by pressing the CANCEL button.

If the OK button is pressed, the ventilator immediately begins operations in PCV, the PCV settings become active and screen in Figure 8-27(a) appears.



Press the **OK** button and go to this screen.



Press the **Review Alarms** button to go to this screen.



Press the **Cancel** button and return to this screen.

Figure 8-27: Destination Screens after Activate Prompt

If the REVIEW ALARMS button is pressed the ventilator immediately displays the screen shown in Figure 8-27(b) appears. If the CANCEL button is pressed, the ventilator returns to the settings screen for the selected breath type as shown in Figure 8-27(c).

5. If the operator elects to review alarm settings, the alarm settings screen for the destination mode is shown (Figure 8-28). All the alarm limits are grayed out in this screen, because the selected breath type (PCV), is not yet active. However the grayed out buttons can be used to adjust values as seems appropriate for the patient.

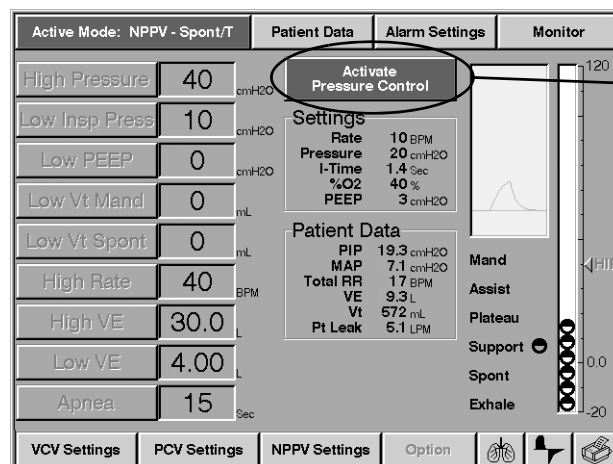

Press to **activate** new breath type.

Figure 8-28: Alarm Limits Screen (PCV active)

6. If the operator reviews alarm settings and then activates the new breath type, the ventilator uses the new breath type and displays the alarm settings of the new breath type (Figure 8-29).

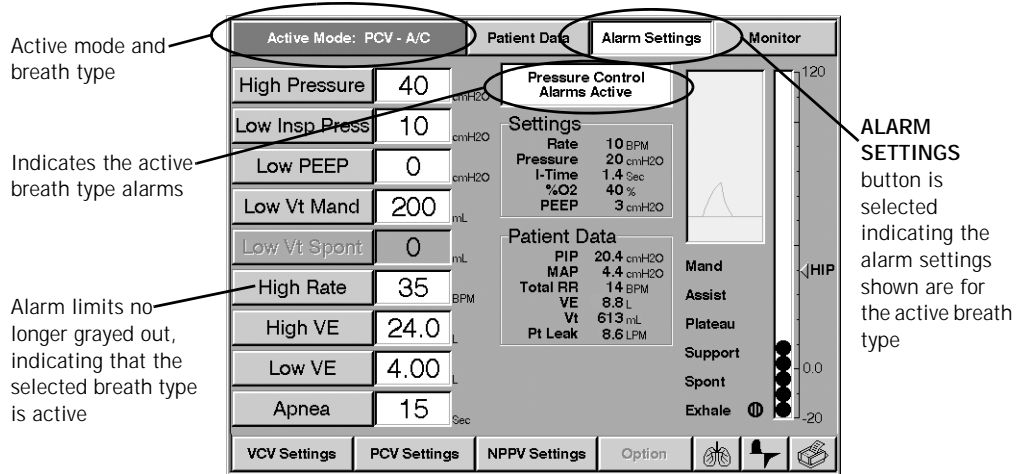

Figure 8-29: Alarm Limits Screen (PCV inactive)

Selecting the Mode (A/C-SIMV-CPAP or Spont-Spont/T)

Summary—Ventilation Modes and Availability		
Ventilation Mode	Available during...	Description
A/C	VCV or PCV	Assist/control: all breaths are mandatory, and are triggered by operator, patient, or ventilator.
SIMV	VCV or PCV	Synchronous intermittent mandatory ventilation: breaths can be mandatory or spontaneous. Mandatory breaths are triggered by operator, patient, or ventilator. PSV is available.
CPAP	VCV or PCV	Continuous positive airway pressure: all patient triggered breaths are spontaneous, and can be pressure supported. PSV is available. The MANUAL BREATH key can be used to initiate a mandatory breath.
Spont	NPPV	Spontaneous ventilation: all breaths are spontaneous and patient triggered. The MANUAL BREATH key can be used to initiate a mandatory breath.
Spont/T	NPPV	Spontaneous Timed ventilation: breaths can be spontaneous or mandatory. The MANUAL BREATH key can be used to initiate a mandatory breath.

Table 8-6: Summary—Ventilation Modes and Availability

The ventilation mode buttons are the selected/not-selected type.

Follow these steps to select the mode:

1. Press the button for the mode you want to select (the active mode is highlighted) from the top bar:
 - If VCV or PCV breath types are active, you can select A/C, SIMV, or CPAP mode (Figure 8-30).
 - If NPPV is active, you can select Spont/T or Spont.



Figure 8-30: Ventilation Mode buttons (A/C and Spont/T active as shown)

2. The ventilator asks you to confirm the mode change (Figure 8-31). Press YES to confirm, or press NO to leave the mode as is.

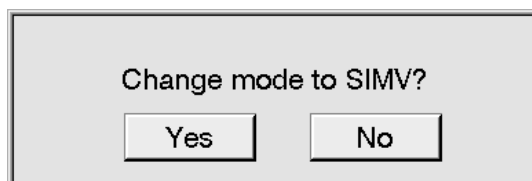

Figure 8-31: Mode Change Confirmation Message

3. Once you confirm a mode change, the ventilator changes the mode selected to active (Figure 8-32).



Figure 8-32: Ventilation Mode buttons (SIMV and Spont shown as active)

Apnea Ventilation

Apnea ventilation provides an emergency mode of ventilation if the ventilator does not deliver a breath for an operator set interval of time. The apnea time can be set between 10 and 60 seconds. Upon entering this mode of ventilation, the ventilator will immediately start using the Apnea Rate setting specified. In PCV and VCV, the ventilator will begin delivering breaths in Assist/Control (A/C), but with the operator set Apnea Rate. In NPPV, the ventilator will deliver only machine controlled breaths either at the set Apnea Rate or in response to patient effort. In Apnea ventilation, the alarms used are the ones used for machine controlled breaths in the active breath type (VCV, PCV and NPPV) that the ventilator was in, when Apnea occurred.

Patient Data Screen

You can view the patient data screen (Figure 8-33) by pressing the PATIENT DATA button in the top bar. The format of this screen is the same in VCV, PCV, and NPPV. Table 8-7: “Patient Data Definitions: Range, Units & Resolution” summarizes the definitions, display ranges, and resolution for patient data parameters.

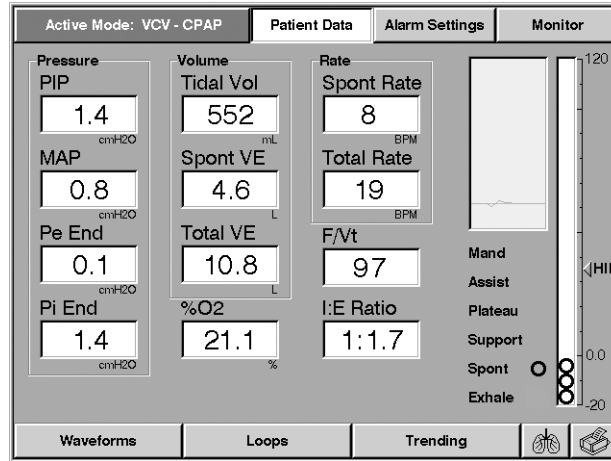

Figure 8-33: Patient Data Screen

Patient Data Definitions: Range, Units & Resolution			
Parameter	Description	Display Range	Resolution
PIP	Peak Inspiratory Pressure The maximum airway pressure during inspiration.	-20.0 to 130 cmH ₂ O (hPa)	0.1 for -20.0 to 99.9 1 for 100 to 130
MAP	Mean Airway Pressure The average of airway pressure during one full breath cycle.	-20.0 to 120 cmH ₂ O (hPa)	0.1 for -20.0 to 99.9 1 for 100 to 130
Pe End	Pressure at End Expiration The pressure measured at the end of expiration.	-20.0 to 99.9 cmH ₂ O (hPa)	0.1
Pi End	Pressure at End Inspiration The pressure measured at the end of inspiration (or at the end of Insp Hold if it is >0).	-20.0 to 130 cmH ₂ O (hPa)	0.1 for -20.0 to 99.9 1 for 100 to 130
Tidal Vol.	Exhaled Tidal Volume The volume exhaled at each breath. Compliance compensated (if enabled).	0 to 9999 ml (BTPS)	1

Table 8-7: Patient Data Definitions: Range, Units & Resolution (Sheet 1 of 2)

Patient Data Definitions: Range, Units & Resolution (Continued)			
Parameter	Description	Display Range	Resolution
Spont VE	Spontaneous Minute Volume The spontaneous ventilation normalized to one minute. Compliance compensated (if enabled).	0.00 to 99.9 L (BTPS)	0.01 for 0.00 to 9.99 0.1 for 10.0 to 99.9
Total VE	Exhaled Minute Volume The total volume exhaled by the patient in one minute. Compliance compensated (if enabled.)	0.00 to 99.9 L (BTPS)	0.01 for 0.00 to 9.99 0.1 for 10.0 to 99.9
% O ₂	Delivered O₂ One second average of O ₂ sensor reading (if O ₂ sensor is installed).	0.0 to 110%	0.01 for 0.00 to 9.99 1 for 100 to 110
Spont Rate	Spontaneous Respiratory Rate The respiratory rate of spontaneous breaths.	0.0 to 150 Bpm	0.1 for 0.0 to 9.9 1 for 10 to 150
Total Rate	Total Respiratory Rate The respiratory rate for all breaths.	0.0 to 150 Bpm	0.1 for 0.0 to 9.9 1 for 10 to 150
F/V _t	Rapid Shallow Breathing Index The ratio of the respiratory rate to exhaled tidal volume for spontaneous breaths.	0 to 150 Bpm/L	1
I:E Ratio	I:E Ratio The ratio of inspiratory time to expiratory time.	9.9:1 to 1:99	0.1 for 9.9:1 to 1:9.9 one (1) for 1:10 to 1:99

Table 8-7: Patient Data Definitions: Range, Units & Resolution (Sheet 2 of 2)

NOTE: Pt. Leak only appears on Patient Data block on Settings screen.

Monitor Screen

The monitor screen (Figure 8-34) is the default screen, and is automatically displayed if the screen has not been touched for 15 minutes. The screen can also be viewed by pressing the MONITOR button. The screen is shown in Figure 8-34. The patient data and settings displayed on this screen depend on the active breath type (Refer to Table 8-8: "Monitor Screen Settings Displayed" and Figure 8-34.)

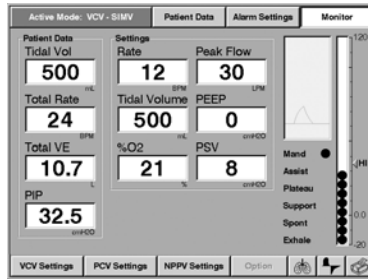

This screen is displayed in VCV.



This screen is displayed in PCV.

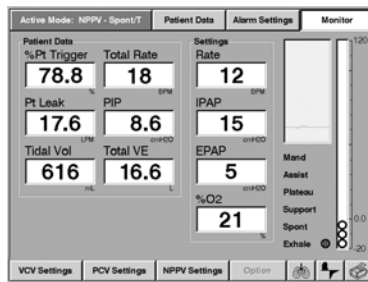

This screen is displayed in NPPV.

Figure 8-34: Monitor Screen

Monitor Screen Settings Displayed	
Ventilation Breath Type	Monitor Screen Settings Displayed
VCV	Rate, Peak Flow, Tidal Volume, PEEP, %O ₂ , Pressure Support
PCV	Rate, Inspiration Time, Pressure, PEEP, %O ₂ , Pressure Support
NPPV	Rate, IPAP, EPAP, %O ₂

Table 8-8: Monitor Screen Settings Displayed

Special Procedures

Auto-PEEP Calculation

The ventilator allows the operator to calculate Auto-PEEP from an expiratory hold procedure. This function is active only at the end of a mandatory breath and is not available in the emergency ventilation mode. Expiratory hold is initiated by pressing the EXP HOLD key on the front panel. When exhalation ends in the breath during which the EXP HOLD key is being pressed, an expiratory hold maneuver will begin and will continue only as long as the key is pressed. During the expiratory hold maneuver, the screen shown in Figure 8-35 below will appear.

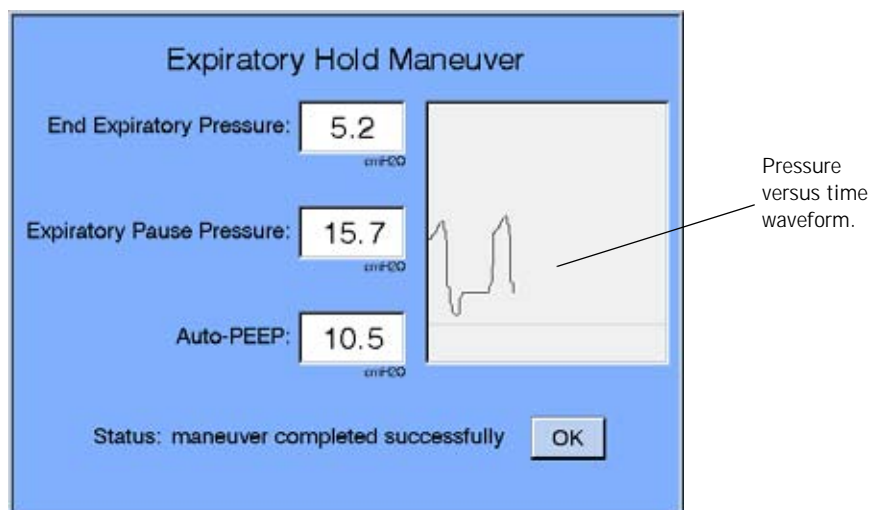

Figure 8-35: Expiratory Hold Maneuver

While the EXP HOLD key is held, the exhalation valve and the air and O₂ valves will be closed. During this period there is no flow of gas into or out of the patient circuit from the ventilator. You can monitor the airway pressure by watching the EXPIRATORY PAUSE PRESSURE digital display, and by watching the pressure versus time waveform. When you determine the airway pressure has stabilized, the EXP HOLD key should be released. If the key is held for 5 seconds, the ventilator will automatically terminate the maneuver and perform the calculation if stability was achieved. The ventilator then calculates Auto-PEEP as shown in the equation below:

- $\text{Auto-PEEP} = \text{Expiratory Pause Pressure} - \text{End Expiratory Pressure}$

NOTE: If the EXP HOLD key is held continuously, and the expiratory hold maneuver exceeds 5 seconds, the ventilator automatically terminates the expiratory hold maneuver and begins a new inspiratory period.

NOTE: If Auto PEEP as calculated in Equation 1: $\text{Auto-PEEP} = \text{Expiratory Pause Pressure} - \text{End Expiratory Pressure}$, is negative, Auto-PEEP will be displayed as "—."

Preoperational Procedure

The preoperational procedure verifies that the ventilator is ready for use on a patient.

WARNING: Ensure that an alternative means of ventilation (that is, a resuscitator or similar device) is available while the ventilator is in use on a patient.

WARNING: DO NOT perform the preoperational procedure when the ventilator is on a patient.

Follow these steps:

1. Follow the setup procedures in Chapter 5, "Setup", to prepare the ventilator for use.
2. Connect the patient circuit to be used on the next patient.
3. Install any components that are to be used in line with the patient circuit (for example, humidifier, O₂ monitor, or airway temperature monitors).

NOTE: All components of the patient circuit must not have leaks in order to pass SST.

4. **Ensure that the ventilator is not on a patient!**
5. Hold down the ALARM RESET and 100% O₂ keys while the ventilator is powered up. The operator must confirm that the machine should be in Diagnostic Mode (Figure 8-36).

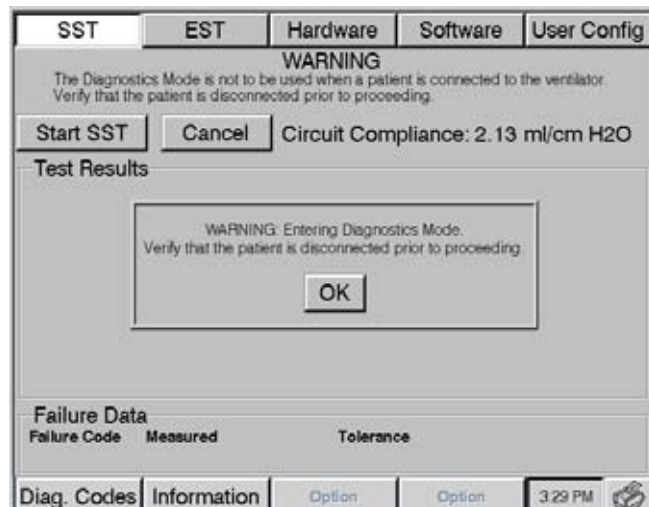

Figure 8-36: Entering Diagnostic Mode

6. Press OK to clear the Warning message and enter Diagnostic Mode.

7. Push USER CONFIG to check time, time format, date and altitude and set compliance compensation as required (Figure 8-37).

NOTE: If time is found to be incorrect more than once in the preoperational procedure, an internal battery may have to be replaced. Contact qualified service personnel or call Respirationics Customer Service at 1-800-345-6443.

8. Press START SST to begin Short Self Test, and follow the screen prompts. Use a cap to plug the patient port of the patient circuit wye at the prompt.
9. During SST, as each test is performed, the ventilator displays test results (Figure 8-37). Do not proceed until the ventilator completes SST without failures.

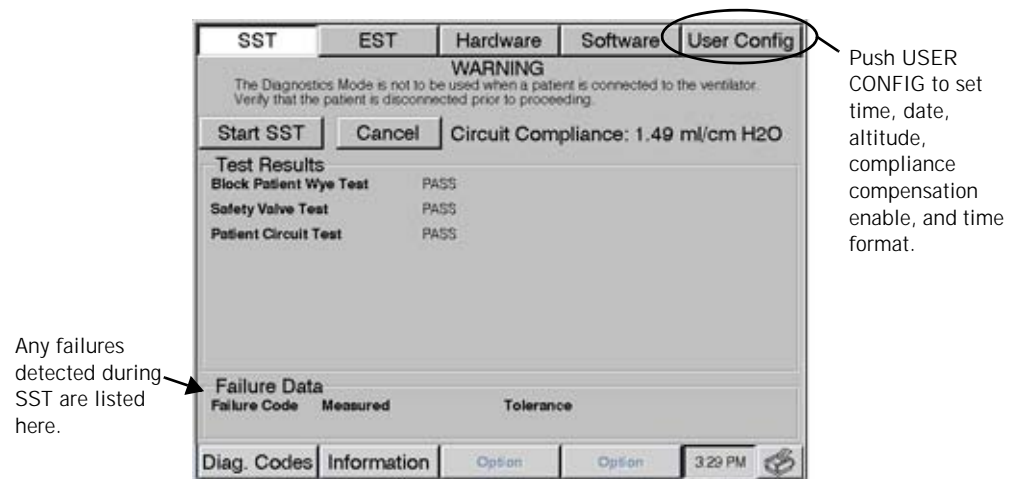

Figure 8-37: SST Results

WARNING: You will be warned if the compliance is 9.0 ml/cmH₂O (hPa) or larger. Patients should not be put on a patient circuit that does not meet this requirement.

Operating Instructions

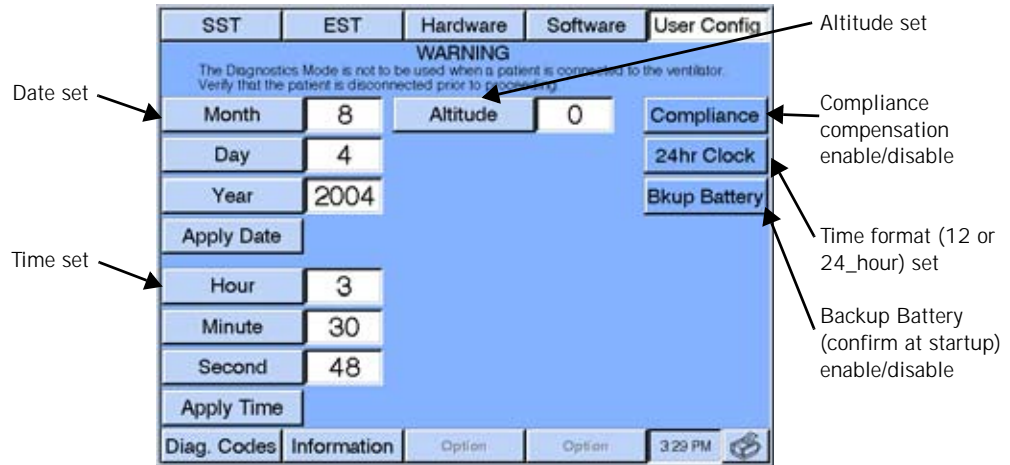

Figure 8-38: User Config Screen

10. Once you have reviewed all the parameters on the User Config screen, the ventilator is ready for patient use. Turn the ventilator off, then on, without holding down any front panel keys.
11. Ventilator settings from the previous use are in effect at power up. Select appropriate settings for the next patient as described in this chapter.

Alarm Testing Procedure

A procedure is available if the operator wants to test the operation of alarms. We recommend following the preoperational procedure. (Refer to C, "Alarm Testing Procedure".)

Where To Go For Help

For clinical or technical support, contact Respirationics Customer Service at 1-800-345-6443.

Chapter 9. Alarms

Introduction

The Respironics V200 Ventilator provides an easy-to-use hierarchical alarm system that includes both visual and audible alarms. When the ventilator detects an operating condition that requires attention, it generates an alarm. The alarm system communicates three levels of urgency and priority:

- **High Urgency:** Alerts the operator that immediate response is required. (red flashing indicator)
- **Medium Urgency:** Alerts the operator that prompt response is required. (yellow flashing indicator)
- **Low Urgency:** Alerts the operator to a change in the ventilator status. (yellow continuous indicator)

In most cases, the alarm will have the following audible and visual components:

- an indicator is illuminated
- a sequence of tones sounds
- a screen alert window appears with a message in it

Visual Alarms

The ventilator includes alarm and status indicators located on the front panel to provide a visual summary of active alarm conditions. Each of these indicators is illuminated by either a red, green, or yellow light, which will flash or remain illuminated, depending on the alarm condition.

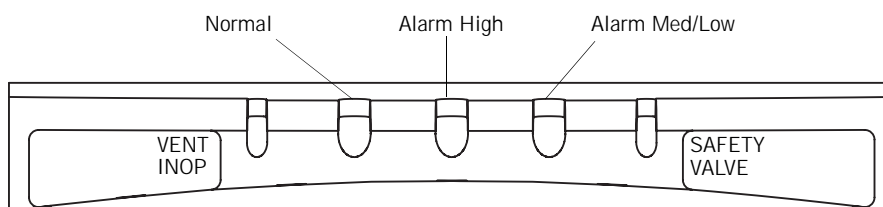

Figure 9-1: Alarm Status Indicators

Pressing the ALARM RESET key on the front panel clears the visual indicators for active or auto-reset alarms. If the alarm condition reoccurs, the visual indicator illuminates again.

Alarm messages also appear in an Alert insert that appears in any screen whenever there is a low, medium, or high urgency alarm active (Figure 9-2).

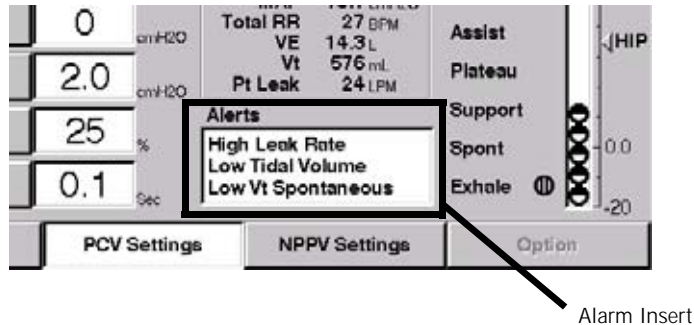

Figure 9-2: Alarm Alerts

Audible Alarms

When an alarm condition exists, the ventilator will generate a sequence of audible tones to alert the operator. The sequence varies according to the urgency and priority level of the alarm:

- **High Urgency:** The ventilator emits a repeating sequence of five tones.
- **Medium Urgency:** The ventilator emits a repeating sequence of three tones.
- **Low Urgency:** No audible tone emitted. (Med/Low indicator illuminates and alarm messages appear in the front panel Alerts window)

When more than one alarm is active, only the highest urgency level alarm is audibly annunciated. Procedures for silencing audible alarms are described below.

Alarm Silence

To silence alarms, perform the following:

- Press the ALARM SILENCE key on the front panel. The audible tone will cease and the alarm silence indicator will illuminate and remain lit for two minutes. Specific alarms that cannot be silenced are listed in Table 9-1: "Alarm Alert Messages".

When ALARM SILENCE is pressed before the end of the two-minute period, the two-minute timer is reset, and alarm silence begins anew. Pressing ALARM SILENCE multiple times does not give multiple two-minute silence periods.

If new alarms occur during alarm silence, all visual alarm annunciation continues. If the Alerts insert is not present, it will appear. The message for any alarms that occur during the alarm silence period will appear in the Alerts insert if there are fewer than three messages currently displayed or the new

message is higher priority than one of the currently displayed messages. The highest three priority messages will be displayed.

ALARM SILENCE is immediately terminated if ALARM RESET is pressed. Any medium or high priority alarm that is active will immediately begin audible annunciation.

CAUTION: The ventilator alarm indicators and the Alerts insert should be monitored closely during the Alarm Silence period to ensure that unexpected alarms are noticed.

Alarm Reset

Automatic Alarm Reset (Auto-Reset)

When the alarm conditions that have caused a medium or high level alarm clear, the audible alarm will terminate automatically (auto-reset). However, after an alarm condition has been corrected, you must press the ALARM RESET key to clear all visual alarm indicators.

Operator-Initiated Alarm Reset

You can clear active and auto-reset alarms by pressing the ALARM RESET key. This clears the alarm messages in the Alerts insert for active and auto-reset alarms. If the alarm condition reoccurs, the alarm restarts at its initial level of urgency and elevates as described in Table 9-1: "Alarm Alert Messages" on page 9-5.

For you to clear an apnea alarm, the ALARM RESET key may be pressed. Once it has been pressed, the ALARM RESET will cancel an existing apnea alarm and return ventilation to the active mode. If the condition that triggered the apnea alarm persists after the ALARM RESET key has been pressed, the apnea alarm will re-trigger. If the patient triggers two successive breaths in apnea ventilation, the ventilator will automatically reset out of apnea ventilation.

CAUTION: If an alarm persists for no apparent reason, contact Respirationics Customer Service at 1-800-345-6443.

Alarm Reset Terminates Alarm Silence

If ALARM SILENCE is active when ALARM RESET is pressed, the ALARM SILENCE period will terminate and any active medium or high priority alarms will become audible.

Alarm Volume Control

Under the left hand bottom edge of the front panel is a partially exposed round control that enables you to control the volume of audible alarms (Figure 9-3).

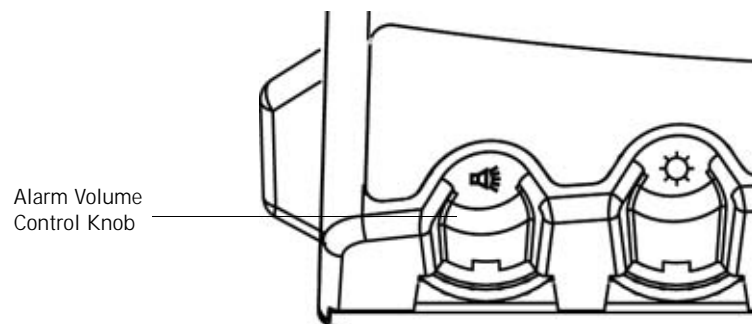

Figure 9-3: Alarm Volume Control

The volume control can be adjusted between a minimum and maximum setting to suit the particular clinical situation.

Alert Messages

When the ventilator detects an alarm condition, it presents an Alert insert below the Patient Data box in the middle of the screen.

While the alarm is active (i.e. visual and audible alarms are still present), the message in the Alert insert appears in bold-faced type. Once the alarm condition has been corrected, the message automatically switches to regular face type. Pressing ALARM RESET clears alarm messages.

When the operator presses the ALARM RESET button (described above), the alarm messages disappear from the alert window.

When the ventilator detects more than three alarm conditions, the three highest priority alert messages will be displayed.

Alert messages, along with the corresponding alarm descriptions, are listed in Table 9-1: "Alarm Alert Messages".

Alarm Alert Messages	
Alert Message	Description
Air Source Fault	A high urgency alarm indicates the internal air source is not functioning properly, patient ventilation continues using the 100% O ₂ gas source if available. Call for service. Cannot be silenced or manually reset.
Apnea	The ventilator triggers a medium urgency alarm condition and enters Apnea Ventilation mode if no inspiration is started within the operator set apnea interval while in a non-emergency breathing mode. It is elevated to high urgency after one minute of Apnea Ventilation.
Audible Alarm Failed	Primary audible alarm is defective. Alarm cannot be manually reset.
Bad ADC Wrap Sensor	Alarm cannot be silenced or manually reset. Call for service.
Bad Bat Volt Sensor	Alarm cannot be silenced or manually reset. Call for service.
Bad Int O ₂ Sensor	Alarm cannot be silenced or manually reset. Call for service.
Bad Int Temp Sensor	Alarm cannot be silenced or manually reset. Call for service.
Battery Backup On	Indicates the backup battery is the power source for ventilator operation. Alarm cannot be silenced.
Exp Valve Stuck Open	Alarm cannot be silenced or manually reset. Call for service.
Gas Supplies Lost - SVO	A high urgency alarm indicates the oxygen and air source are no longer operable. Safety valve opens. Check O ₂ source and internal air source. Call for service. Cannot be silenced or manually reset.
High Inspiratory Pressure	Indicates that circuit pressure exceeds the high pressure limit. When High Inspiratory Pressure condition occurs, the ventilator immediately cycles into the exhalation phase and illuminates the low priority indicator. Then on the second consecutive breath with a pressure violation, sounds the audible alarm, lights the Alarm High indicator, and displays High Inspiratory Pressure message.
High Internal O ₂	Oxygen concentration internal to the enclosure is beyond allowable levels. Indicative of an internal O ₂ leak. Alarm cannot be silenced or manually reset.
High Leak Rate	The average estimated leak from the previous breath has exceeded the set High Leak alarm limit (alarm applies to NPPV mode only). Medium urgency, escalates to high urgency after 60 seconds. The alarm cancels when the estimated leak from the previous breath equals or falls below the alarm setting, if the ventilation type changes from NPPV to another ventilation mode or if the alarm is reset by the clinician.

Table 9-1: Alarm Alert Messages (Sheet 1 of 4)

Alarm Alert Messages (Continued)	
Alert Message	Description
High Minute Volume	Indicates total minute ventilation (VE) measured in exhalation is higher than the set limit. This alarm is available in Volume Control and Pressure Control modes. It is elevated to high urgency after one minute.
High O ₂	A high urgency alarm indicates that the monitored O ₂ concentration is at least 6% above the set value (%O ₂) for 30 seconds. Verify operation of the O ₂ sensor. Alarm cannot be manually reset.
High Respiratory Rate	The ventilator triggers a medium urgency alarm if the total respiratory rate is greater than the operator-set High Respiratory Rate limit. The ventilator evaluates this alarm condition at the start of inspiration, after calculating the total respiratory rate including the just completed breath. It is elevated to high urgency after one minute.
High Temperature	Internal temperature monitor detects higher than allowed temperatures inside the enclosure. Alarm cannot be silenced or manually reset.
I-Time Too Long	The ventilator triggers a medium urgency alarm to indicate that a spontaneous breath has exceeded the maximum allowed inspiratory time of 3.5 seconds (2.5 seconds in Pediatric mode). The alarm is elevated to high urgency after two consecutive breaths that meet the alarm criteria.
Low Backup Battery	If the backup battery is low, a high priority alarm will be triggered. Immediately connect an AC power source to avoid a loss of power. Provide AC power and/or replace the backup battery. Alarm cannot be silenced or manually reset. 5 minutes or less of battery run time remains.
Low EPAP	If the Exhalation Positive Airway Pressure is less than the operator set Low EPAP Pressure limit for one second, the ventilator signals a medium urgency condition. If the Low EPAP alarm remains active for one minute, the ventilator elevates the alarm to high urgency.

Note: A Low EPAP setting of zero (0) will disable this alarm.

Note: If an inspiration is triggered immediately after the mandatory minimum exhalation time of 200 msec, this alarm will not be activated unless this condition occurs for three consecutive breaths.

Table 9-1: Alarm Alert Messages (Sheet 2 of 4)

Alarm Alert Messages (Continued)	
Alert Message	Description
Low Insp Pressure	<p>If the peak airway pressure during any mandatory inhalation is less than the Low Insp Pressure limit, the ventilator will immediately signal a high priority alarm.</p> <p>Note: If an inspiration is triggered immediately after the mandatory minimum exhalation time of 200 msec, this alarm will not be activated unless this condition occurs for three consecutive breaths.</p>
Low Minute Volume	<p>Indicates the measured patient minute ventilation (VE) is below the set limit. It is elevated to high urgency after one minute.</p> <p>Note: A Low Minute Volume setting of zero (0) will disable this alarm.</p>
Low O ₂	<p>A high urgency alarm indicates that the monitored O₂ concentration is 18% or at least 6% below set value for 30 seconds. Verify operation of the O₂ sensor. Alarm cannot be manually reset.</p>
Low O ₂ Supply	<p>A high urgency alarm indicates that O₂ gas supply is below acceptable levels and the %O₂ setting is above 21%. Check O₂ gas connections and inlet filter. Alarm cannot be manually reset.</p>
Low PEEP	<p>If PEEP is less than the operator set Low PEEP limit for one second during exhalation, triggers a medium priority alarm. If the Low PEEP alarm remains active for one minute, the alarm moves to high priority.</p> <p>Note: A Low PEEP setting of zero (0) will disable this alarm.</p> <p>Note: If an inspiration is triggered immediately after the mandatory minimum exhalation time of 200 msec, this alarm will not be activated unless this condition occurs for three consecutive breaths.</p>
Low Tidal Volume	<p>The ventilator triggers a medium urgency alarm to indicate that the NPPV (mandatory or spontaneous breath) tidal volume is less than the set limit. It is elevated to a high urgency alarm after one minute.</p> <p>Note: A Low Tidal Volume setting of zero (0) will disable this alarm.</p>

Table 9-1: Alarm Alert Messages (Sheet 3 of 4)

Alarm Alert Messages (Continued)	
Alert Message	Description
Low Vt Mandatory	<p>The ventilator triggers a medium urgency alarm to indicate that the VCV or PCV mandatory tidal volume is less than the set limit. It is elevated to high urgency after one minute.</p> <p>Note: A Low Vt setting of zero (0) will disable this alarm.</p> <p>Note: If an inspiration is triggered immediately after the mandatory minimum exhalation time of 200 msec, this alarm will not be activated unless this condition occurs for three consecutive breaths.</p>
Low Vt Spontaneous	<p>The ventilator triggers a medium urgency alarm to indicate that the VCV or PCV spontaneous tidal volume is below the set alarm limit. It is elevated to high urgency after one minute.</p> <p>Note: A Low Vt setting of zero (0) will disable this alarm.</p>
O ₂ Valve Stuck Closed	Alarm cannot be silenced or manually reset. Call for service.
Occlusion - SVO	Safety Valve opens. The ventilator triggers a high urgency alarm to indicate that an occlusion has been detected in the patient circuit. Check circuit tubing for crimped hoses or blockage. Check filters and humidification devices to ensure they are functioning properly. Alarm cannot be manually reset.
Restart	The ventilator has restarted. If the ventilator repeatedly restarts on its own, call for service.
Using Default Altitude	Ventilator is using default altitude.
Using Default Compliance	Ventilator is using default compliance.
Using Default Settings	Ventilator is using default settings.

Table 9-1: Alarm Alert Messages (Sheet 4 of 4)

Alarm Indicators

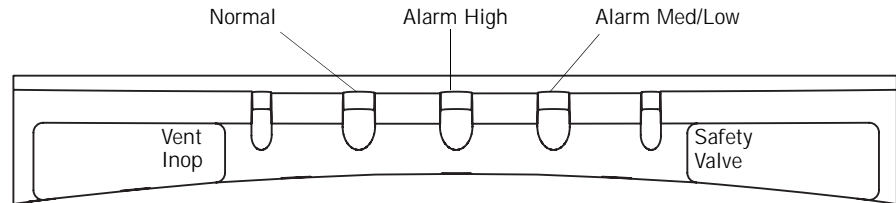

Figure 9-4: Alarm and Status Indicators

Normal

The Normal indicator remains lit with a steady green light as long as there are no active or auto reset alarm conditions present.

Alarm High

The Alarm High indicator visually indicates a high priority alarm. When a high priority alarm condition exists, this indicator flashes red and an audible five tone sequence sounds until the condition is corrected or reset.

WARNING: A high priority, visual and audible alarm indicates a potentially life-threatening condition and immediate response is required.

Alarm Med/Low

The Alarm Med/Low indicator visually indicates a medium or low priority alarm. When a medium priority alarm condition exists, this indicator will flash yellow and an audible three tone sequence will be heard until the condition is corrected. When a low priority alarm condition exists, this indicator remains lit with a steady yellow light, until the alarm is reset.

Vent Inop

The Vent Inop indicator signals the operator that the ventilator is not capable of supporting ventilation and requires service. During a ventilator inoperative condition, the ventilator enters a safe state, where the safety valve is opened and new alarm condition detection is discontinued. If the ventilator is attached to a patient when this condition is detected, the ventilator must be replaced immediately.

WARNING: Vent Inop is a serious condition, which is indicated by both visual and audible alarms. If the ventilator is attached to a patient when Vent Inop occurs, the patient must be supported with another means of life support ventilation.

When a ventilator inoperative condition is detected, the Vent Inop indicator will display a steady red light, and the ventilator will sound a five-tone audible alarm sequence.

The Vent Inop alarm cannot be reset by an operator. It cannot be auto-reset or silenced. The ventilator must be serviced by a qualified service representative, in order for the Vent Inop audible and visual alarms to be cleared.

Safety Valve

This indicator signals that the Safety Valve is open and the ventilator is not providing breath support to the patient. It is accompanied by a five-tone audible alarm sequence and a Safety Valve Open message in the touch screen display.

The Safety Valve opens automatically whenever the ventilator is not able to provide breath support to the patient. It allows the patient to spontaneously breathe room air through the ventilator system.

The Safety Valve Open condition is normal during start-up and restart, and it automatically turns off when the start-up sequence is complete. If this condition occurs at any other time, it cannot be reset. Immediately use an alternative ventilation source and call for service.

WARNING: When the safety valve open indicator is lit, the ventilator does not provide any ventilatory support to the patient. Immediately use a backup means of ventilatory support.



Alarm Silence

The indicator (🔔) on the Alarm Silence key will illuminate with a steady yellow light whenever the operator presses the alarm silence control. The indicator remains lit for two minutes after the Alarm Silence key is pressed. If Alarm Silence is active and an alarm takes place that involves an operator alarm limit being exceeded, the alarm will be announced visually, but Alarm Silence will continue to be active and the Alarm Silence timer will continue to time out. Alarms that can not be silenced are listed in Table 9-1: "Alarm Alert Messages" on page 9-5. If Alarm Reset is pressed at any time during the Alarm Silence period, the Alarm Silence period is terminated. If any high or medium priority alarm condition exists after pressing Alarm Reset, an audible alarm sounds.

WARNING: Visually monitor the patient and ventilator during the Alarm Silence period to ensure that alarms do not go undetected. Allowing alarm conditions to continue without intervention may result in harm to the patient and/or ventilator.

Chapter 10. Care and Maintenance

General Information

Procedures for ventilator cleaning, sterilizing, and periodic maintenance must be performed to ensure consistent ventilator operation. Institutional policies may also provide guidelines, procedures, and schedules for cleaning and sterilizing equipment before, during and after patient use.

In addition, recommended methods and time frames for performing all necessary care and maintenance procedures for the ventilator are presented in this section.

Respironics recognizes that cleaning, sterilization, sanitation and disinfecting practices vary widely among health care institutions. It is not possible for Respironics to specify or require specific practices that will meet all needs, or to be responsible for the effectiveness of cleaning, sterilization, and other practices carried out in the patient care setting.

General procedures for cleaning and sterilizing the ventilator are described in the following sections. Some ventilator parts must be disassembled before cleaning and sterilizing. (Refer to "Removing and Replacing Internal Air Source Inlet Filter" on page 10-10.)

Cleaning

When cleaning parts, avoid the use of hard brushes or other instruments likely to cause surface damage.

CAUTION: Care should be taken when cleaning the touch display. (Refer to Figure 8-2 on page page 8-3). A soft moist cloth should be used that does not drip water and/or soap solution when in contact with the display. After cleaning and rinsing with a damp cloth, remove all moisture with a dry, soft cloth. Never allow solutions of any kind to collect on the bottom bezel of the display. Never use a brush or device that can cause abrasion to clean the touch display or its bezel; they will cause irreparable damage.

CAUTION: Follow the detergent manufacturer's instructions. Exposure to detergent solution stronger than necessary can shorten the useful life of the product. Rinse parts thoroughly to remove all detergent residues. Wipe parts dry. Detergent residue can cause blemishes or fine cracks, especially on parts exposed to elevated temperatures during sterilization.

Sterilization

WARNING: Do not expose expiratory and inspiratory bacteria filters or reusable patient tubing to ETO gas.

NOTE: Because conditions and practices in health care institutions vary, this manual can only describe general guidelines. It is the user's responsibility to ensure the validity and effectiveness of the methods used.

Do not clean, disinfect, sterilize or reuse disposable products.

Steam Autoclaving

The O₂ sensor tee (P/N 1001736) and the O₂ sensor coupling (P/N 1002505) may be steam autoclaved. The PVC O₂ sensor tee, P/N 8-100498-00 (gray in color), cannot be autoclaved.

CAUTION: Autoclavable parts will withstand repeated steam autoclaving at temperatures not to exceed 135° C (275°F).

1. Ensure that the part has been disassembled, cleaned, and partially reassembled, as applicable.
2. Separately wrap the part in muslin or equivalent paper wrapper.
3. Steam autoclave according to the autoclave manufacturers instructions. In many institutions it may be routine to place a biological indicator in the autoclave load as a subsequent test for sterility.
4. Aseptically store parts until used.

CAUTION: DO NOT autoclave the ventilator.

Chemical Disinfecting

The O₂ sensor tee (P/N 1001736) and the O₂ sensor coupling (P/N 1002505) may be chemically disinfected. The PVC O₂ sensor tee, P/N 8-100498-00 (gray in color), cannot be chemically disinfected.

For chemically disinfected parts, reassemble after disinfecting.

CAUTION: Formaldehyde, phenol-based, and quaternary ammonium compound (QUATS) disinfectants are not recommended because these agents can cause cracking and crazing of plastic parts. Exposure of components to disinfectant concentrations stronger than required or for excessive time may shorten product life. Parts should be thoroughly rinsed and dried to prevent spotting and blemishes when exposed to elevated temperatures.

1. Separately immerse each part in the chemical disinfectant, i.e. ammonia (15% solution), bleach (10% solution) or commercial, hospital grade disinfectant, etc. Follow the disinfectant manufacturers directions for the solution concentration, immersion times, and other conditions for disinfecting. The use of a laminar air flow hood during the chemical disinfecting process is recommended.
2. Thoroughly rinse and dry each part.
3. Aseptically reassemble (as required) and store the part until use.

Ventilator Exterior

Wipe the ventilator exterior clean with a damp cloth and mild detergent. Do not use liquid or aerosol bactericide. Do not allow moisture to come in contact with the touch panel screen or to collect between the keypad and front bezel assembly.

CAUTION: DO NOT allow liquid to penetrate the ventilator rear or front panel. DO NOT attempt to sterilize the ventilator by exposing to ETO gas. DO NOT steam-autoclave.

CAUTION: Care should be taken when cleaning the touch display. (Refer to Figure 8-2 on page page 8-3). A soft moist cloth should be used that does not drip water and/or soap solution when in contact with the display. After cleaning and rinsing with a damp cloth, remove all moisture with a dry, soft cloth. Never allow solutions of any kind to collect on the bottom bezel of the display. Never use a brush or device that can cause abrasion to clean the touch display or its bezel; they will cause irreparable damage.

Patient Circuit Support Arm

Wipe the patient circuit support arm clean with alcohol or bactericide.

O₂ Gas Supply Filter/Water Trap

Wipe the exterior of the O₂ gas supply filter/water trap with a mild solution of soap and water. Rinse and dry parts. Do not steam-autoclave, chemically disinfect, or expose to ETO gas. Do not allow liquid to migrate into the inlet port.

Reusable Patient Circuit Tubing, Couplings, and Connectors

Disassemble and clean manually followed by steam-autoclave. Follow all institutional guidelines for autoclaving.

Visually inspect tubing for nicks, cuts and holes prior to use with the ventilator.

Reusable In-line Water Traps

Disassemble and clean water traps as per the manufacturers instructions. Inspect for cracks or leaks prior to use with the ventilator. Replace if cracked or leaking.

Bacteria Filters

Bacteria filters are typically used on the inspiratory and expiratory port connections on the front of the ventilator. Filter locations are illustrated below.

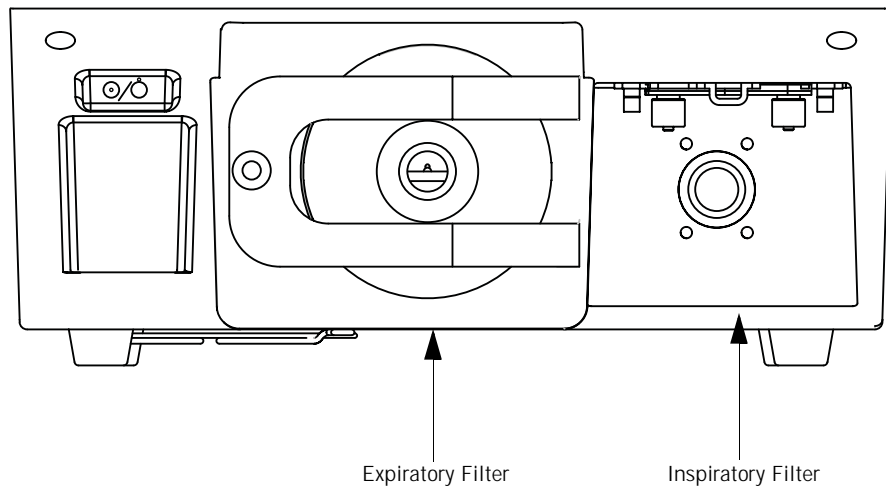

Figure 10-1: Inspiratory and Expiratory Bacteria Filter Locations

The inspiratory filter port is a 22mm standard connector. Use the filter supplied with the ventilator.

The expiratory port includes a heated exhalation compartment. Use the filter supplied with the ventilator.

WARNING: Disposable or single-patient filters must be discarded between patients. Do not chemically disinfect or expose single patient use bacteria filters to ETO gas.

Removing and Replacing Inspiratory Bacteria Filter

Follow the steps outlined below to remove and replace the inspiratory bacteria filter.

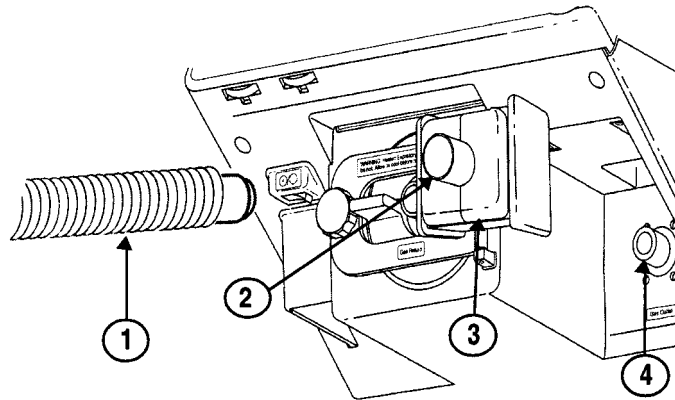

Figure 10-2: Removing and Replacing Inspiratory Bacteria Filter

1. Disconnect circuit tubing (1) from inspiratory bacteria filter outlet (2).
2. Disconnect filter (3) from the gas outlet (4). If optional O₂ sensor is installed, ensure it is not dislodged. When used, O₂ sensor is located between gas outlet (4) and filter (3).
3. Insert new filter onto the gas outlet (4) with flow direction indicator (on the filter) pointing away from the ventilator.
4. Reconnect circuit tubing (1) to new filter outlet (2).

Removing and Replacing Expiratory Bacteria Filter

Refer to the illustration below and follow the steps outlined below to remove and replace the expiratory bacteria filter.

WARNING: The expiratory filter housing may be hot if removed from the ventilator immediately after use. Wait 15 minutes after turning off ventilator power before removing the heated expiratory bacteria filter. Exercise caution when handling the filter housing.

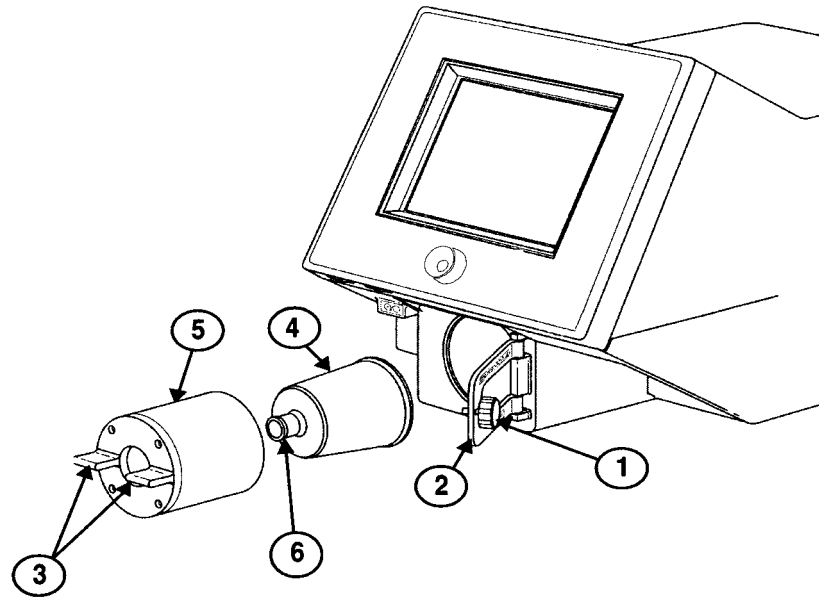

Figure 10-3: Removing and Replacing Expiratory Bacteria Filter

1. Disconnect circuit tubing from filter inlet (not shown).
2. Unscrew knob (1) to unlatch retaining bracket (2).
3. Open retaining bracket (2).
4. Use tabs (3) to gently remove heater housing (5) and filter (4) from the ventilator.
5. Do not touch heater housing. If ventilator has not been turned off and heater housing has not been allowed to cool, it may be hot to the touch.
6. Carefully remove filter (4) from heater housing (5).
7. Tap filter input port (6) if filter (4) cannot be easily removed from housing (5).
8. Insert new filter into housing (5).
9. Reinstall housing (5) and new filter and close retaining bracket (2).
10. Connect circuit.

Periodic Maintenance

This section includes detailed operator maintenance.

Schedule for Periodic Maintenance		
Frequency	Component	Maintenance
During ventilator setup	<ul style="list-style-type: none"> Inspiratory bacteria filter Ventilator and patient circuit components Inspiratory and expiratory filters 	<ul style="list-style-type: none"> Check filter for occlusions, cracks and tears. Perform SST (Short Self-Test) whenever circuit components are changed Perform EST (Extended Self-Test) between patient uses Ensure that the ventilator functions normally with both filters in place
At least daily, and as recommended by filter manufacturers	<ul style="list-style-type: none"> Inspiratory and expiratory filters <p>CAUTION: Do not operate the ventilator without a properly functioning expiratory filter and heater. Doing so may cause damage to delicate ventilator components, such as the expiratory flow sensor, which may lead to inaccurate spirometry or a Vent Inop condition.</p> <p>WARNING: Vent Inop is a serious condition which is indicated by both visual and audible alarms. If the ventilator is attached to a patient when Vent Inop occurs, the patient must be supported with another means of life support ventilation.</p>	<ul style="list-style-type: none"> Monitor performance of filters and replace as needed. Review ventilator patient graphics frequently for changes in expiratory resistance which may indicate degradation of expiratory filter. Follow filter manufacturer recommendations regarding duration of use, maintenance (for reusable filters), removal and disposal. Note that high humidity and aerosol medications may reduce expiratory filter life, increase expiratory resistance, and/or cause filter damage.
At least daily	<ul style="list-style-type: none"> Oxygen supply water trap and filter 	<ul style="list-style-type: none"> Check and empty as required every shift
At least every 250 hours	<ul style="list-style-type: none"> Air Inlet & Fan Filters 	<ul style="list-style-type: none"> Inspect and clean. Some environments cause a quicker collection of lint and dust than others, requiring maintenance more frequently than every 250 hours.
Annually	<ul style="list-style-type: none"> Annual preventive maintenance kit (P/N 1034840). Kit contents are subject to change. <p>CAUTION: The annual preventive maintenance procedure is to be performed only by a qualified service technician</p>	<ul style="list-style-type: none"> Install annual preventive maintenance kit. Clean ventilator interior and exterior Complete performance verification procedure

12,500 hours	<ul style="list-style-type: none"> 12,500 hour preventive maintenance kit (P/N 1001733). Kit contents are subject to change. 	<ul style="list-style-type: none"> Install 12,500 hour preventive maintenance kit Clean ventilator interior and exterior Complete performance verification procedure
<p>CAUTION: The 12,500 hour preventive maintenance procedure is to be performed only by a qualified service technician.</p>		
As required	<ul style="list-style-type: none"> External oxygen sensor Backup Battery 	<ul style="list-style-type: none"> Replace and recalibrate new sensor by running Extended Self-Test For charging and maintenance instructions, see "Backup Battery" on page 4-4.

Table 10-1: Schedule for Periodic Maintenance

Removing Cooling Filter



Figure 10-4: Removing Cooling Filter

Refer to Figure 10-4.

1. Remove black filter retaining bracket (1). (Pry off if necessary.)
2. Wash filter (2) in soapy water.
3. Dry thoroughly before reinstalling.

CAUTION: Do not remove any screws from the cooling filter area. Removing screws from this area will result in damage to internal components.

Removing and Replacing O₂ Input Filter Element

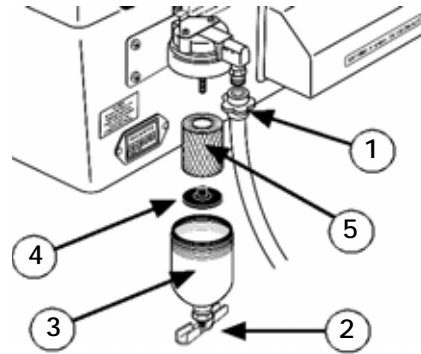

Figure 10-5: Removing and Replacing O₂ Input Filter Element

Refer to Figure 10-5.

1. Disconnect O₂ Hose (1).
2. Unscrew filter housing (3).
3. Unscrew filter element retaining screw (4).
4. Remove and replace filter element (5).
5. Reconnect filter element retaining screw (4).
6. Reinstall filter housing (3).
7. Reconnect O₂ hose (1).
8. Check system for leaks prior to patient use.

Removing and Replacing Internal Air Source Inlet Filter

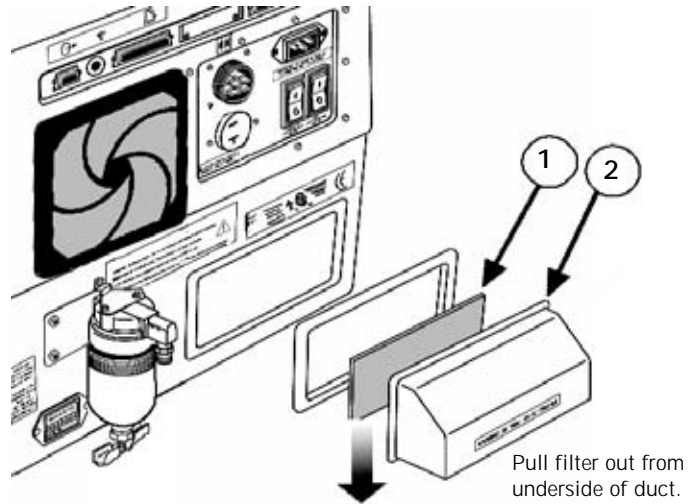

Figure 10-6: Removing and Replacing Internal Air Source Inlet Filter

Refer to Figure 10-6. Figure 10-6 shows exploded view of the duct (2) and filter (1), but it does not have to be disassembled.

1. Move the ventilator so that there is easy access to the underside of the internal air source duct (2).
2. The internal air source filter (1) can be removed manually. The filter can be reached from under the internal air source duct (2) as indicated by the arrow.
3. Wash internal air source filter (1) with mild soap and water.
4. Rinse thoroughly then pat dry.
5. Reinstall internal air source filter (1) from underneath the duct (2) in the same fashion it was removed.

Storage

If you need to store the ventilator for fifteen days or more, ensure that the altitude, temperature and humidity of the storage site fall within the following ranges:

- Environmental Temperature: -20 to 60°C (-4 to 140° F)
- Relative Humidity: 10 to 100% noncondensing
- Maximum Altitude: 6,560 m (20,000 ft.)

Repairs

For technical service or repairs not included in this chapter, refer to the Esprit/V200 Ventilator Service Manual, P/N 580-1000-02 or contact Respirationics Customer Service at 1-800-345-6443.

Chapter 11. Diagnostics

The Diagnostic Mode allows you to:

- Run short self test (SST)
- Run extended self test (EST)
- Run hardware diagnostics to help you troubleshoot SST or EST failures
- Check the software revision of the ventilator
- Set user configuration, including:
 - time and date
 - compliance compensation enable/disable
 - local altitude and time format
 - backup battery (confirm at startup) enable/disable
- Check diagnostic codes.

WARNING: The patient must be disconnected from the ventilator before entering the Diagnostic Mode since normal ventilation is suspended.

CAUTION: Troubleshooting and repair should be performed only by a qualified service technician.

NOTE: The “Hardware” function and EST in the Diagnostics Mode should only be run by qualified personnel.

Entering Diagnostic Mode

To enter Diagnostic Mode, hold down the ALARM RESET and 100% O₂ keys for approximately 5 seconds while you turn on the ventilator. A message appears on the ventilator prompting you to confirm that the patient is disconnected before entering Diagnostic Mode (Figure 11-1). Press OK to enter Diagnostic Mode.

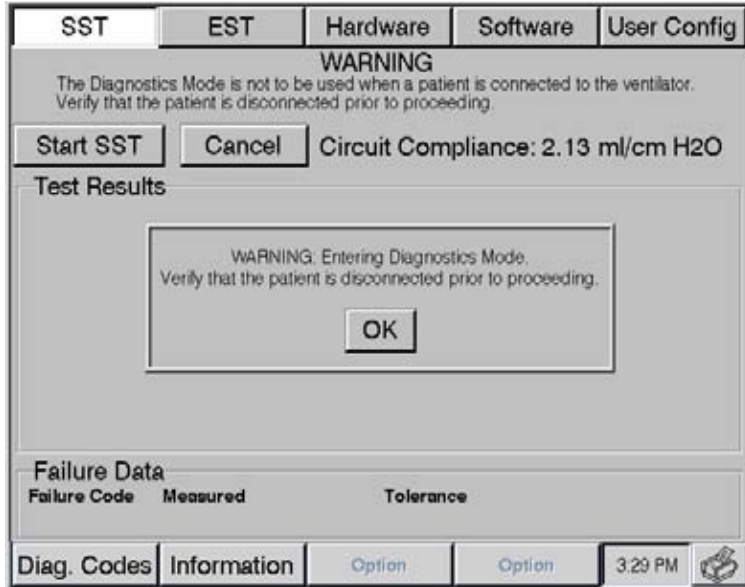

Figure 11-1: Entering Diagnostic Mode

Once you've entered Diagnostic Mode, you can select any of diagnostic functions by pressing its button. Change values in Diagnostic Mode the same way you change ventilator settings.

Diagnostic Functions

Short Self Test (SST)

SST verifies the integrity of the patient circuit tubing by measuring its leak rate and compliance. SST also tests critical hardware components, including the safety valve, flow sensors, and autozero solenoids. Perform SST before every patient circuit change. If SST passes, the ventilator and all attached components are ready for use.

WARNING: Do not use a ventilator that has failed SST without verifying operational readiness by other means. Doing so may place a patient at risk.

WARNING: Never initiate SST while the patient is connected to the ventilator. The high airway pressures generated during SST can injure a patient.

Equipment required to run SST:

- Patient circuit to be used on the next patient including any devices installed in line with the circuit (such as a humidifier, O₂ sensors, and/or temperature sensor).
- Plug or cap for the patient wye

Follow these steps to run SST:

1. Connect the circuit to be used on the next patient to the ventilator.
2. Press the SST button (Figure 11-1) on the diagnostic screen.
3. Press the Start SST button to begin the test.
4. When prompted, unplug the patient wye and press the OK button.
5. When prompted, plug the patient wye and press the OK button.
6. When SST completes successfully, press the OK button.

When SST is completed, the calculated circuit compliance is displayed on the screen.

Extended Self Test (EST)

EST verifies the overall functional integrity of the ventilator by testing all critical hardware subsystems and components. Perform EST between patients as part of preventive maintenance, a performance verification, or if the operational integrity of the ventilator is in question. EST is typically run by qualified trained personnel.

WARNING: Never initiate EST while the patient is connected to the ventilator. The high airway pressures and gas flows generated during EST can injure a patient.

WARNING: Do not use a ventilator that has failed EST without verifying operational readiness by other means. Doing so may place a patient at risk.

CAUTION: If the optional external O₂ sensor is in-line, it must be calibrated during EST.

Equipment required to run EST:

- Patient circuit
- Plug for the patient wye
- High pressure O₂ source

Follow these steps to run EST:

1. Enter Diagnostic Mode as described "Entering Diagnostic Mode" on page 11-2.
2. Connect a patient circuit to the ventilator.
3. Press the EST button on the diagnostic screen (Figure 11-1).
4. Press START EST to begin EST.
5. Follow the prompts.
6. When EST completes successfully, press the OK button.

Hardware

The hardware function allows a trained service technician to operate critical components separately to help identify a faulty component in the event that the ventilator fails SST, EST, or performance verification testing. For more information on the Hardware function, see the Esprit/V200 Ventilator Service Manual, P/N 580-1000-02.

Software

The software function displays the ventilators serial number, software part numbers, and version numbers and the part numbers of other critical components.

User Config

The User Config function allows you to:

- Set the date and time when first setting up the ventilator.
- Set the altitude for the location of the ventilator. This setting allows for more accurate tidal volume delivery.
- Enable or disable the automatic patient circuit compliance compensation feature. Compliance compensation corrects the delivered volumes of VCV mandatory breaths for patient circuit compliance. It also corrects all exhaled volume for patient circuit compliance volume. The COMPLIANCE button is grey when compliance compensation is disabled and white when compliance compensation is enabled.
- Set the time format (AM/PM or 24 hour).
- Enable or disable the confirmation that the backup battery is connected each time that the machine powers on.

Diagnostic Codes

The Diagnostic Codes function allows you to review the diagnostic log in ventilator memory.

To view the diagnostic codes, press the DIAGNOSTIC CODE button on the diagnostic screen. The ventilator displays the following information:

- Number: Diagnostic codes are numbered in reverse order of occurrence (most recent first).
- Code: The number assigned to a specific diagnostic code; used in determining the cause of a possible failure.
- Repeat: If the same code occurs consecutively, this parameter will be incremented rather than creating a new entry in the log. For example, if the diagnostic code 1002 occurs three consecutive times, it is logged as diagnostic code 1002 and the repeat column is 2. The repeat column increments until a different diagnostic code occurs.
- Time: Diagnostic codes are time stamped in hour:minute:second format (for example: 09:15:23). When the same diagnostic code repeats, the time stamp represents the most recent occurrence of the diagnostic code.
- Date: Diagnostic codes are date stamped in month/day/year format (for example: 03/12/98). When the same diagnostic code repeats, the date stamp represents the most recent occurrence of the diagnostic code.
- Corrupted: The microprocessor cross checks the data in memory prior to display. If it determines that the memory contents have been corrupted, it logs a YES indicating that the memory contents validity is suspect.

Diagnostic codes associated with EST and SST are only recorded the first time the failure is encountered.

The log holds the last 20 diagnostic codes. The screen can only display 10 codes at a time. Press NEXT PAGE button to see the next group of codes or PREV PAGE to view the previous group.

The CLEAR CODES button allows a qualified service technician to delete codes from the log. Because diagnostic codes provide the primary means of fault diagnosis, they should only be cleared by or under the advice of qualified personnel.

CAUTION: Diagnostic codes should only be cleared by qualified personnel.

Table 11-1: "Diagnostic Codes and Descriptions", summarizes some diagnostic codes and their descriptions. The codes and descriptions for SST and EST are identical except that SST codes are preceded by a 2 and EST codes are preceded by a 3. For example, if code 106 occurred during an SST, it would be logged as 2106. If it occurred during an EST, it would be logged as 3106.

WARNING: Remove the ventilator from service and contact trained service personnel if any diagnostic codes appear with the exception of: 1, 3, 2000, 3000, 5000, 5002, 8003, or 8004.

WARNING: Use of a ventilator that has not passed SST or EST is against the strongest recommendation of Respirationics.

Diagnostic Codes and Descriptions	
Code	Description
1	Normal mode startup
3	Diagnostic Startup
2XXX	Short Self Test
2000	SST Passed
2106	Patient Circuit Leak
2107	Inh Pressure Too Low
2110	Check Valve 3 Leak
2125	Inhalation Pressure/Exhalation Pressure Disagreement
2128	Circuit Compliance Out of Range
2129	Pressure Leak Out of Range
2130	Safety Valve Cannot Open
2131	Patient Wye Not Blocked

Table 11-1: Diagnostic Codes and Descriptions (Sheet 1 of 4)

Diagnostic Codes and Descriptions (Continued)	
Code	Description
2134	Cannot Calibrate Air Flow Sensor
2135	Cannot Calibrate O ₂ Flow Sensor
2136	Cannot Calibrate Exh Flow Sensor
2137	Verify Failure—Air Flow Sensor Cal
2138	Verify Failure—O ₂ Flow Sensor Cal
2139	Verify Failure—Exh Flow Sensor Cal
2140	Cannot Erase Flow Sensor Tables
2141	Cannot Open Inh Autozero Solenoid
2142	Cannot Open Exh Autozero Solenoid
2152	Patient Wye Not Unblocked
3XXX	Extended Self Test
3000	EST Passed
3100	Canceled By User
3101	Air Stepper Motor Outside Range
3102	O ₂ Stepper Motor Outside Range
3103	Air Flow Outside Range
3104	O ₂ Flow Outside Range
3105	Exh Flow Outside Range
3106	Patient Circuit Leak
3107	Inh Pressure Too Low
3108	Exh Pressure Outside Range
3109	Check Valve 2 Leak
3110	Check Valve 3 Leak
3111	O ₂ Not Connected
3112	O ₂ Not Disconnected
3113	FiO ₂ Sensor Sample Out of Range
3114	FiO ₂ Sensor Average Out of Range
3115	Primary Audio Not Sounding
3116	Backup Audio Not Sounding
3117	Crossover Circuit Fault
3118	Blower Off Switch Failure
3119	Blower DAC Failure
3120	Pressure Relief Valve Cracking Pressure Too High
3121	Pressure Relief Valve Cracking Flow Not Stable
3122	Pressure Relief Valve Cracking Pressure Too Low

Table 11-1: Diagnostic Codes and Descriptions (Sheet 2 of 4)

Diagnostic Codes and Descriptions (Continued)	
Code	Description
3123	O ₂ Valve Cracking Flow Outside Range
3124	O ₂ Valve Full Flow Outside Range
3125	Air Flow Sensor/Exh Flow Sensor Disagreement or Inhalation Pressure/Exhalation Pressure Disagreement
3126	O ₂ Flow Sensor/Exh Flow Sensor Disagreement
3127	Heated Filter Backpressure Out of Range
3128	Circuit Compliance Out of Range
3129	Pressure Leak Out of Range
3130	Safety Valve Cannot Open
3131	Patient Wye Not Blocked
3132	keyboard Failure
3133	Rotary Knob Failure
3134	Cannot Calibrate Air Flow Sensor
3135	Cannot Calibrate O ₂ Flow Sensor
3136	Cannot Calibrate Exh Flow Sensor
3137	Verify Failure—Air Flow Sensor Cal
3138	Verify Failure—O ₂ Flow Sensor Cal
3139	Verify Failure—Exh Flow Sensor Cal
3140	Cannot Erase Flow Sensor Tables
3141	Cannot Open Inh Autozero Solenoid
3142	Cannot Open Exh Autozero Solenoid
3143	Air Step Position for Open—Outside Range
3144	Air Step Position for Midpoint—Outside Range
3145	Air Step Position for Close—Outside Range
3146	O ₂ Step Position for Open—Outside Range
3147	O ₂ Step Position for Midpoint—Outside Range
3148	O ₂ Step Position for Close—Outside Range
3149	Exh Step Position for Open—Outside Range
3150	Exh Step Position for Midpoint—Outside Range
3151	Exh Step Position for Close—Outside Range
3152	Patient Wye Not Unblocked
3153	Touchscreen Failure
3154	LED Indicator Failure
3155	Remote Alarm Not Sounding
3156	Inh. Transducer Autozero Failure
3157	Exh. Transducer Autozero Failure

Table 11-1: Diagnostic Codes and Descriptions (Sheet 3 of 4)

Diagnostic Codes and Descriptions (Continued)	
Code	Description
3158	Exhalation Valve initial pressure —Outside Range
3159	Exhalation Valve final pressure —Outside Range
3160	Exhalation Valve flow —Outside Range
5XXX	Safety Valve Open or Backup Battery Not connected
5000	Occlusion - Safety Valve Open Alarm
5001	Gas Supplies Lost - Safety Valve Open Alarm
5002	Backup Battery Not Connected
8XXX	Software Diagnostic information
8003	Software Option Button Failure
8004	Insufficient Blower Current

Table 11-1: Diagnostic Codes and Descriptions (Sheet 4 of 4)

WARNING: Please contact Respironics Customer Service at 1-800-345-6443 or consult your service manual if any diagnostic codes are encountered.

Information

The Information function is reserved for future expansion.

Option

The Option function is reserved for future expansion.

Self Test

Introduction

The Respironics V200 ventilator has an extensive system of checks designed into the system to ensure that it operates safely and detects fault conditions that can compromise the performance of the system as a ventilator. These checks include hardware that checks the integrity of the software and software that checks the hardware to ensure that it is operating within normal ranges. These checks are described below.

Self-Test Hardware

The self-test hardware involves hardware components that check the integrity of the software. The hardware components that perform these checks are the watchdog timer and the bus activity monitor.

- **Watchdog Timer:** The watchdog timer is a timer that the software must reset. If the timer times out, it causes a reset that restarts the ventilator as if the power switch had been turned on. Normally the software resets the watchdog timer and it never times out.
- **Bus Activity Monitor:** The bus activity monitor is a timer similar to the watchdog timer. The bus activity monitor timer is a timer that only times out if there has been no activity on the microprocessor bus. If there is no activity on the bus, it would indicate there is a malfunction of some kind and the microprocessor is restarted in the same way that the watchdog timer does.

Power On Self Test (POST)

POST is the test that the ventilator does when the machine power is turned on or if there has been a potential fault detected by the watchdog timer or the bus activity monitor. POST has the constraint that it must be able to run safely when the ventilator has a patient attached. POST checks the integrity of critical system electronics such as the self test hardware and microprocessor electronics. POST also tests other critical ventilator components that can be tested.

A primary objective of POST is to ensure that the watchdog timer and the bus activity monitor hardware are working and will catch software malfunctions. These are critical components of the safety system and therefore POST tests these components every time it runs.

POST also checks all critical digital hardware, including the processor, program memory, data memory, and functions of various measurement systems.

POST also checks pneumatic components that can be safely tested with the safety valve open.

If all of these tests pass, the Respironics V200 ventilator will operate as a ventilator.

Built-In Test

When the Respirationics V200 ventilator is operating as a ventilator, it is constantly making reasonableness checks on the operation of the hardware to ensure that failures have not occurred and that the hardware appears to be operating normally. Also, while the microprocessor is operating, there is execution time available that is not required for ventilator operation. When execution time is available, the microprocessor runs many of the hardware tests that are run during POST. These include Program memory, RAM memory, and other measurements that can be tested without interfering with the operations of the ventilator.

The ventilator's safety system of hardware checking software and software checking hardware means that the ventilator only operates as a ventilator if the extensive constraints of the safety system are met.

Restart

During normal operation, the ventilator performs background checks to ensure the integrity of the system. If a problem is detected, the ventilator enters the "restart" sequence, in which it opens the safety valve while it performs additional integrity checks. Restart is 10 to 20 seconds, depending upon the reason for the restart. The ventilator sounds an alarm and displays a visual message indicating the unit is in a restart sequence. In some cases, a countdown timer will display the number of seconds remaining until the ventilator completes the restart cycle. If, during the restart sequence, an actual problem is confirmed, the ventilator enters the "Vent Inop" state, in which it activates audible and visual alarms while the safety valve remains open. Alternatively, if at the end of the restart sequence the ventilator determines it is safe to continue operation, the unit will return to normal ventilation.

NOTE: A "restart" is an infrequent event.

(This page is intentionally blank.)

Chapter 12. Technical Specifications

Breath Types

Breath Types	
Volume Controlled Ventilation	VCV
Pressure Controlled Ventilation	PCV
Non-Invasive Positive Pressure Ventilation	NPPV
Apnea Ventilation	

Table 12-1: Breath Types

Modes

Modes	
Assist/Control (A/C)	VCV, PCV
SIMV	VCV, PCV
CPAP	VCV, PCV
Spont/T	NPPV
Spont	NPPV

Table 12-2: Modes

Volume Ventilation Settings, Ranges and Resolution

Resolution is one unit unless otherwise noted (cmH₂O is considered numerically equivalent to hPa).

Volume Ventilation Settings, Ranges & Resolution	
Setting	Range
Respiratory Rate	1 to 80 Bpm
Tidal Volume	50 to 2500 mL
Peak Inspiratory Flow	3 to 140 Lpm (Compliance compensated, actual to 200 Lpm)
PEEP	0 to 35 cmH ₂ O (hPa)
PSV Pressure	0 to 100 cmH ₂ O (hPa)

Table 12-3: Volume Ventilation Settings, Ranges and Resolution (Sheet 1 of 2)

Volume Ventilation Settings, Ranges & Resolution (Continued)	
Setting	Range
Inspiratory Trigger (I-trigger)	
Pressure Sensitivity	-20 to -0.1 cmH ₂ O (hPa) (Resolution is 0.1 cmH ₂ O (hPa))
Flow Sensitivity	0.5 to 20 LPM (Resolution is 0.1 LPM)
Expiratory Trigger (E-Cycle)	
% Peak Flow	10 to 80% of inspiratory peak flow
Rise Time	0.1 to 0.9 seconds (Resolution is 0.1 second)
%O ₂	21% to 100%
Insp. Hold	0 to 2.0 seconds (Resolution is 0.1 second)
Flow Waveform	Descending ramp, square
Patient Type	Adult/Pediatric

Table 12-3: Volume Ventilation Settings, Ranges and Resolution (Sheet 2 of 2)

Pressure Control Ventilation Settings, Ranges and Resolution

Resolution is one unit unless otherwise noted (cmH₂O is considered numerically equivalent to hPa).

Pressure Control Ventilation Settings, Ranges & Resolution	
Setting	Range
Apnea Rate	1-80 Bpm
Respiratory Rate	1 to 80 Bpm
PCV Pressure	5 to 100 cmH ₂ O (hPa) (Relative to PEEP)
Inspiratory Time	0.1 to 9.9 seconds (Resolution is 1 second)
PEEP	0 to 35 cmH ₂ O (hPa)
PSV Pressure	0 to 100 cmH ₂ O (hPa) (Relative to PEEP)
Inspiratory Trigger (I-trigger)	
Pressure Sensitivity	-20 to -0.1 cmH ₂ O (hPa) (Resolution is 0.1 cmH ₂ O (hPa))
Flow Sensitivity	0.5 to 20 LPM from base flow of 3 LPM above sensitivity (Resolution is 0.1 LPM)
Expiratory Trigger (E-Cycle)	
% Peak Flow	10 to 80% of inspiratory peak flow

Table 12-4: Pressure Control Ventilation Settings, Ranges & Resolution (Sheet 1 of 2)

Pressure Control Ventilation Settings, Ranges & Resolution (Continued)

Setting	Range
Rise Time	0.1 to 0.9 seconds
%O ₂	21% to 100%
Patient Type	Adult/Pediatric

Table 12-4: Pressure Control Ventilation Settings, Ranges & Resolution (Sheet 2 of 2)

Non-Invasive Positive Pressure Ventilation Settings, Ranges and Resolution

Resolution is one unit unless otherwise noted (cmH₂O is considered numerically equivalent to hPa).

Non-Invasive Positive Pressure Ventilation Settings, Ranges & Resolution

Setting	Range
Respiratory Rate	1 to 80 Bpm
EPAP	2 to 25 cmH ₂ O (hPa)
IPAP	2 to 35 cmH ₂ O (hPa)
Inspiratory Time	0.1 to 9.9 seconds (Resolution is 0.1 second)
Rise Time	0.1 to 0.9 seconds
Inspiratory Trigger (I-trigger)	
Flow Sensitivity	0.5 to 20 LPM from base flow of 3 LPM above sensitivity (Resolution is 0.1 LPM)
Expiratory Trigger (E-Cycle)	
% Peak Flow	10 to 80% of inspiratory peak flow
%O ₂	21% to 100%
Apnea Rate	1-80 Bpm
Patient Type	Adult/Pediatric

Table 12-5: Non-Invasive Positive Pressure Ventilation Settings, Ranges and Resolution

Maximum delivered flow during pressure controlled breaths in NPPV is limited to 100 LPM for the pediatric patient type.

Apnea Ventilation

Apnea ventilation is considered equivalent to Assist Control with Apnea Rate in VCV and PCV. In NPPV, only mandatory breaths are delivered, triggered either at the Apnea Rate or by the patient.

Value Entry Message

If you enter a value that is outside the operational limits of the ventilator, you will be shown a message window on the screen. Once you acknowledge the message, the ventilator returns to the value modification display without changing the value.

Assist/Control Ventilation Value Entry Reasonability Checks		
Item	Limit Exceeded	Message
Apnea Rate	I:E Ratio>3:1	I:E Ratio must be less than or equal to 3:1. Check V_t , Peak Flow, or Insp. Hold
Peak Flow	I:E Ratio>3:1	I:E Ratio must be less than or equal to 3:1. Check V_t , Apnea Rate, or Insp. Hold.
Tidal Volume	I:E Ratio>3:1	I:E Ratio must be less than or equal to 3:1. Check Flow, Apnea Rate, or Insp. Hold.
Insp. Hold	I:E Ratio>3:1	I:E Ratio must be less than or equal to 3:1. Check V_t , Apnea Rate or Peak Flow.
Waveform	I:E Ratio>3:1	I:E Ratio must be less than or equal to 3:1. Check V_t , Peak Flow or Apnea Rate.
I-Time	I-Time>9 sec.	I-Time must be less than or equal to 9 sec. Check V_t , Peak Flow, Insp. Hold or Waveform.

Table 12-6: Assist/Control Ventilation Value Entry Reasonability Checks

Pressure Control Ventilation Value Entry Reasonability Checks			
Item	Limit Exceeded	Message	Changed
Apnea Rate	I:E Ratio>4:1	I:E Ratio must be less than or equal to 4:1.Check I-Time.	Readjust the Apnea Rate or adjust I-Time or Rate.
I-Time	I:E Ratio>4:1	I:E Ratio must be less than or equal to 4:1.Check Apnea Rate.	Readjust the I-Time or adjust Apnea Rate or Rate.
I-Time	I-Time<Rise Time	I-Time must greater than or equal to Rise Time.	Increase the Rise Time or increase the I-Time.
Rise Time	Rise Time>I Time	Rise Time must be less than I-Time.	Decrease the Rise Time or increase the I-Time.

Table 12-7: Pressure Control Ventilation Value Entry Reasonability Checks

Non-Invasive Ventilation Value Entry Reasonability Checks			
Item	Limit Exceeded	Message	Changed
Apnea Rate	I:E Ratio>4:1	I:E Ratio must be less than or equal to 4:1. Check I-Time.	Readjust the Apnea Rate or adjust I-Time or Rate.
I-Time	I:E Ratio>4:1	I:E Ratio must be less than or equal to 4:1. Check Apnea Rate.	Readjust the I-Time or adjust Apnea Rate or Rate.
IPAP	IPAP<EPAP	IPAP must be greater than or equal to EPAP.	Readjust IPAP higher or adjust EPAP lower.
EPAP	EPAP>IPAP	EPAP must be less than or equal to IPAP.	Readjust EPAP lower or adjust IPAP higher.
Rise Time	Rise Time>I Time	Rise Time must be less than I-Time.	Decrease the Rise Time or increase the I-Time.

Table 12-8: Non-Invasive Ventilation Value Entry Reasonability Checks

General Value Entry Reasonability Checks			
Item	Limit Exceeded	Message	Changed
Apnea	Apnea Rate<Set Rate	Apnea Rate must be greater than or equal to the Set Rate.	Increase the Apnea Rate or decrease the Rate.

Table 12-9: General Value Entry Reasonability Checks

Patient Data Screen

Monitored patient data is displayed when Patient Data is pressed. Patient data ranges, resolution, units, and accuracy specifications are provided in the table below. Minute volume data is based on an eight breath average.

Patient Data Range, Resolution, Units & Accuracy				
Patient Data	Display Range	Units	Resolution	Accuracy
Exhaled Minute Volume	0.00 to 99.9	L	0.01 for 0.00-9.99; 0.1 for 10.0-99.9	±10%
Exhaled Tidal Volume	0 to 9999	mL	1	±10%
Spontaneous Minute Volume	0.00 to 99.9	L	0.01 for 0.00-9.99; 0.1 for 10.0-99.9	±10%
Rapid Shallow Breathing Index	0 to 500	Bpm/L	1	±10%

Table 12-10: Patient Data Range, Resolution, Units & Accuracy (Sheet 1 of 2)

Patient Data Range, Resolution, Units & Accuracy (Continued)				
Patient Data	Display Range	Units	Resolution	Accuracy
I:E	9.9:1 to 1:99	none	0.1 for 9.9:1-1:9.9; 1 for 1:10-1:99	±10%
Peak Inspiration Pressure	-20.0 to 130	cmH ₂ O (hPa)	1 for 100-130; 0.1 for -20.0 to 99.9	±10%
End Inspiration Pressure (Pi End)	-20.0 to 130	cmH ₂ O (hPa)	1 for 100-130; 0.1 for -20.0 to 99.9	±10%
Mean Airway Pressure	-20.0 to 120	cmH ₂ O (hPa)	1 for 100-120; 0.1 for -20.0 to 99.9	±10%
Delivered O ₂ %	0.0 to 110	--	1 for 100-110; 0.1 for -20.0 to 99.9	±3 vol%
Total Respiratory Rate	0.0 to 150	Bpm	1 for 10-150; 0.1 for 0.0 to 9.9	±10%
Spontaneous Respiratory Rate	0.0 to 150	Bpm	1 for 10-150; 0.1 for 0.0 to 9.9	±10%
End Exhalation Pressure (Pe End)	-20.0 to 99.9	cmH ₂ O (hPa)	0.1	±10%
Patient Leak (Pt Leak)	0.0 to 140	LPM	0.1 for 0.0-99.9 1 for 100-140	Not specified ^a
Percent Patient Trigger (%Pt Trigger)	0.0 to 99.9	%	0.1 for 0.0-99.9 1 for 100	±10%

Table 12-10: Patient Data Range, Resolution, Units & Accuracy (Sheet 2 of 2)

a. Due to the variable nature of patient leaks, this parameter is an estimate only.

Front Panel Keys







Front Panel Keys	
	Alarm Silence
	Screen Lock
	Alarm Reset
	Expiratory Hold
	100% O ₂
	Accept
	Manual Breath

Table 12-11: Front Panel Keys

Level Controls



Level Controls		
Control		Adjustment
	Display Brightness (underneath front panel keys)	Continuous (min to max)
	Alarm Volume (underneath front panel key)	Continuous (54 to 77 db)
	Adjust Control	Continuous—to change values on screen

Table 12-12: Level Controls

Calculated Values from Expiratory Hold Maneuver

Calculated Values from Expiratory Hold Maneuver	
Value	Range
End Expiratory Pressure	-20 to 120 cmH ₂ O (hPa)
Expiratory Pause Pressure	-20 to 120 cmH ₂ O (hPa)
Auto PEEP (calculated range)	0 to 120 cmH ₂ O (hPa)

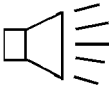
Table 12-13: Calculated Values from Expiratory Hold Maneuver

Interface Ports

Interface Ports
Parallel Printer Port future
RS-232 output and input
Analog Output 0 to 5 VDC full-scale feature
Remote Alarm Nurse Call and Remote Alarm Annunciation

Table 12-14: Interface Ports

Environmental Specifications

Environmental Specifications		
Temperature/Humidity	Operating	10° to 40°C (50° to 104°F) 10 to 95% R.H. (non-condensing)
	Storage	-20° to 60°C (-4° to 140°F) 10 to 100% R.H. (non-condensing)
Atmospheric Pressure	Operating	700 to 1060 cmH ₂ O (hPa)
	Storage	500 to 1060 cmH ₂ O (hPa)
Altitude	Operating	0 to 3280m (0 to 10,000 ft.)
	Storage	up to 6560m (20,000 ft.)
Oxygen Inlet Supply	Pressure	276 to 620 kPa (40-90 psig)
	Flow	200 L/min. minimum

Table 12-15: Environmental Specifications

Environmental Protection

Environmental Protection	
Batteries	Do not dispose of in fire, possible explosion hazard. Do not dispose of in garbage, recycle lead batteries.
Ventilator Enclosure	The system plastic enclosure should not be disposed of in fire, possible toxic fumes may be generated.
General	The system and accessories (bacteria filters, patient tubing, etc.) may be subject to medical hazardous waste regulations. Consult with local authorities for proper disposition of the system and accessories at the end of their useful life.

Table 12-16: Environmental Protection

Alarms

Alarms		
Alarm Controls	Audible Alarm Volume	adjustable, 45 dB(A) to 85 dB(A)
	Alarm Silence	120 seconds
	Alarm Reset	

Table 12-17: Alarms (Sheet 1 of 2)

Alarms (Continued)		
Alarm Settings	High Inspiratory Pressure	10 to 105 cmH ₂ O (hPa)
	Low Inspiratory Pressure	3 to 105 cmH ₂ O (hPa)
	Low PEEP Pressure	0 to 35 cmH ₂ O (hPa)
	High Respiratory Rate	0 to 150 Bpm
	Low Exhaled Mandatory Tidal Volume	0 mL to 2500 mL
	Low Exhaled Spontaneous Tidal Volume	0 mL to 2500 mL
	Low Exhaled Minute Volume	0 to 60 Lpm
	High Exhaled Minute Volume	0 to 60 Lpm
	High Leak (NPPV mode only)	0 to 60 Lpm
Alarm Status Indicators	Normal Indicator	
	High Urgency Alarm (flashing red)	
	Medium/Low Urgency Alarm (flashing yellow/steady yellow)	
	Alarm Silence	
	Safety Valve Open	
	Ventilator Inoperative (steady red)	
	Screen Locked	

Table 12-17: Alarms (Sheet 2 of 2)

Connectors

Connectors	
Inspiratory Limb Connector	Gas outlet port: 22 mm conical male
Expiratory Limb Connector	Gas return port (on expiratory filter): Proprietary barb fitting
	NOTE: The gas return port on the ventilator is a cylindrical port which requires mating to a specified expiratory filter to seal the expiratory limb.
Oxygen Inlet	DISS male, DISS female, NIST, Air Liquide, or SIS Fitting (depending on country and configuration).

Table 12-18: Connectors

Filters

Filters	
Inspiratory	See filter instruction sheets for complete specification. Bacterial Filter Efficiency: 99.999+% Viral Filtration Efficiency: 99.99+%
Expiratory	See filter instruction sheets for complete specification. Typical efficiency: 99.97% for nominal particle size of 0.3 micro meter (micron) at 100L/min flow.

Table 12-19: Filters

Measuring and Display Devices

Measuring and Display Devices		
Pressure Measurements	Type	Solid State
	Sensing Position	Inhalation output port Exhalation input port
	Measurements	Patient airway pressure
Volume Measurements	Type	Hot Film Anemometer flow integrated
	Sensing Position	O ₂ , air and exhalation
	Measurements	O ₂ flow, air flow and exhalation flow
Oxygen Measurements	Type	Zirconia solid electrolyte
	Sensing Position	Internal enclosure
	Measurements	Oxygen concentration (range 0 to 95%)
	Type	Galvanic cell
	Sensing Position	Inspiratory limb of VBS
	Measurements	Delivered O ₂ % (range 0 to 110%)
Settings, Alarms and Data Display	Type	TFT liquid crystal touch screen

Table 12-20: Measuring and Display Devices

AC Power and Battery Indicators





AC Power & Battery Indicators	
Loss of Power (audible only)	Backup Battery Low 
External Battery In Use 	Backup Battery In Use 
Backup Battery Charging 	Mains 

Table 12-21: AC Power & Battery Indicators

Leakage Current

Leakage Current		
Ventilator	Earth Leakage Current	100 to 240VAC; 300 μ A maximum
	Enclosure/Patient Leakage Current	100 to 240VAC; 100 μ A maximum

Table 12-22: Leakage Current

WARNING: When connecting a humidifier to the humidifier outlet (available only on 100-120 VAC ventilators) allowable leakage current values may be exceeded.

Compliance and Approvals

Compliance and Approvals	
	The Respironics V200 ventilator system complies with the requirements of the European Directive 93/42/EEC concerning medical devices and the requirements of Directive 89/336/EEC relating to electromagnetic compatibility.
IEC 601-1 Classification	Protection class 1, type B applied part, drip proof, continuous operation.
The ventilator system complies with these international and European Standards.	IEC 601-1/EN60601-1 IEC 601-1-2/EN60601-1-2 EN 794-1
The ventilator system has been certified by the following.	CSA/NRTL: CSA C22.2 No. 601-1, CSA C22.2 No. 601-2-12, UL2601-1

Table 12-23: Compliance and Approvals

Power Requirements

Power Requirements	
Configuration	Voltages & Frequencies
Ventilator Only	100 to 240VAC, 50/60Hz, 6 amp max. or 100 to 120VAC, 50/60Hz, 6 amp max. depending on configuration
Ventilator Only	24VDC, 8AH, Backup Battery pack (operating time approximately 30 minutes)
Ventilator with Humidifier	100 to 120VAC, 50/60Hz, 9 amp max.

Table 12-24: Power Requirements

Technical Specifications

NOTE: The humidifier power connection is available only on 100-120VAC ventilators.

Dimensions and Weights

Dimensions and Weights		
	Ventilator	Cart
Height	17 inches (42 cm)	42 inches (107 cm)
Width	15 inches (38 cm)	23 inches (58 cm)
Depth	25 inches (65 cm)	37 inches (95 cm)
	29 inches with water trap filter (74 cm)	
Weight	66 pounds (30 kg)	80 pounds (36.2 kg) With backup battery - 93 pounds (42 kg)

Table 12-25: Dimensions and Weights

Electromagnetic Compatibility Declaration

Guidance and Manufacturer's Declaration - Electromagnetic Emissions		
The ventilator is intended for use in the electromagnetic environment specified below. The user of the ventilator should assure that it is used in such an environment.		
Emissions Test	Compliance	Electromagnetic Enforcement - Guidance
RF Emissions CISPR 11	Group 1	The ventilator uses RF energy only for its internal function. Therefore, its RF emissions are very low and are not likely to cause interference in nearby electronic equipment.
RF Emissions CISPR 11	Class A	The ventilator is suitable for use in all establishments, including domestic establishments and those directly connected to the public low voltage power supply network that supplies buildings used for domestic purposes.
Harmonic emissions IEC 61000-3-2	Class A	
Voltage fluctuations/flicker emissions IEC 61000-3-3	Complies	

Table 12-26: EMC Declaration - Emissions

Guidance and Manufacturer's Declaration - Electromagnetic Immunity			
The ventilator is intended for use in the electromagnetic environment specified below. The user of the ventilator should assure that it is used in such an environment.			
Immunity Test	IEC 60601 Test Level	Compliance Level	Electromagnetic Environment - Guidance
Electrostatic Discharge (ESD) IEC 61000-4-2	±6kV contact ±8kV air	±6kV contact ±8kV air	Floors should be wood, concrete or ceramic tile. If floors are covered with synthetic material, the relative humidity should be at least 30%.
Electrical Fast Transient/burst IEC 61000-4-4	±2kV for power supply lines. ±1kV for input/output lines	±2kV for power supply lines. ±1kV for input/output lines	Mains power quality should be that of a typical hospital environment
Surge IEC 61000-4-5	±1kV differential mode ±2kV common mode	±1kV differential mode ±2kV common mode	Mains power quality should be that of a typical hospital environment
Voltage dips, short interruptions and voltage variations on power supply input lines IEC 61000-4-11	<5% U_T (>95% dip in U_T) for 0.5 cycle 40% U_T (60% dip in U_T) for 5 cycles 70% U_T (30% dip in U_T) for 25 cycles 5% U_T (>95% dip in U_T) for 5 sec	<5% U_T (>95% dip in U_T) for 0.5 cycle 40% U_T (60% dip in U_T) for 5 cycles 70% U_T (30% dip in U_T) for 25 cycles 5% U_T (>95% dip in U_T) for 5 sec	Mains power quality should be that of a typical hospital environment. If the user of the ventilator requires continued operation during power mains interruptions, it is recommended that the ventilator be powered from an external battery.
Power Frequency (50/60Hz) magnetic field IEC 61000-4-8	3 A/m	3 A/m	Power frequency magnetic fields should be at levels characteristic of a typical location in a typical hospital environment.

NOTE: U_T is the a.c. mains voltage prior to application of the test level.

Table 12-27: EMC Declaration - Immunity

Guidance and Manufacturer's Declaration - Electromagnetic Immunity			
The ventilator is intended for use in the electromagnetic environment specified below. The user of the ventilator should assure that it is used in such an electromagnetic environment.			
Immunity Test	IEC 60601 Test Level	Compliance Level	Electromagnetic Environment - Guidance
Conducted RF IEC 61000-4-6	3 Vrms 150 kHz to 80 MHz outside ISM bands ^a	3Vrms	Portable and mobile RF communications equipment should be used no closer to any part of the ventilator, including cables, than the recommended separation distance calculated from the equation applicable to the frequency of the transmitter. Recommended separation distance Table 12-29: "EMC Declaration - Recommended Distances" . $d = \left[\frac{3.5}{V_1} \right] \sqrt{P}$
Radiated RF IEC 61000-4-3	10 Vrms 150kHz to 80 MHz in 10 V/m 80Mhz to 2.5GHz	10 Vrms 10 V/m	$d = \left[\frac{12}{V_2} \right] \sqrt{P}$ $d = \left[\frac{12}{E_1} \right] \sqrt{P}$ 80Mhz to 800Mhz $d = \left[\frac{23}{E_1} \right] \sqrt{P}$ 800Mhz to 2.5GHz
			where P is the maximum output power rating of the transmitter in watts (W) according to the transmitter manufacturer and d is the recommended separation distance in meters (m). ^b Field strengths from fixed RF transmitters, as determined by an electromagnetic site survey, ^c should be less than the compliance level in each frequency range. ^d Interference may occur in the vicinity of equipment marked with the following symbol: 

Table 12-28: EMC Declaration - Immunity

Guidance and Manufacturer's Declaration - Electromagnetic Immunity	
NOTE 1	At 80 MHz and 800 MHz, the higher frequency range applies.
NOTE 2	These guidelines may not apply in all situations. Electromagnetic propagation is affected by absorption and reflection from structures, objects and people.
a	The ISM (industrial, scientific and medical) bands between 150 kHz and 80 MHz are 6.765 MHz to 6.795 MHz; 13.553 MHz to 13.567 MHz; 26.957 MHz to 27.283 MHz; and 40.66 MHz to 40.70 MHz.
b	The compliance levels in the ISM frequency bands between 150 kHz and 80 MHz and in the frequency range 80 MHz to 2.5 GHz are intended to decrease the likelihood that mobile/portable communications equipment could cause interference if it is inadvertently brought into patient areas. For this reason, an additional factor of 10/3 is used in calculating the recommended separation distance for transmitters in these frequency ranges.
c	Field strengths from fixed transmitters, such as base stations for radio (cellular/cordless) telephones and land mobile radios, amateur radio, AM and FM radio broadcast and TV broadcast cannot be predicted theoretically with accuracy. To assess the electromagnetic environment due to fixed RF transmitters, an electromagnetic site survey should be considered. If the measured field strength in the location in which the ventilator is used exceeds the applicable RF compliance level above, the ventilator should be observed to verify normal operation. If abnormal performance is observed, additional measures may be necessary, such as re-orienting or relocating the ventilator.
d	Over the frequency range 150 kHz to 80 MHz, field strengths should be less than 1 V/m.

Table 12-28: EMC Declaration - Immunity

Technical Specifications

Recommended Separation Distances Between Portable and Mobile RF Communications Equipment and the Respironics V200 Ventilator				
The ventilator is intended for use in an electromagnetic environment in which radiated RF disturbances are controlled. The user of the ventilator can help prevent electromagnetic interference by maintaining a minimum distance between portable and mobile RF communications equipment (transmitters) and the ventilator as recommended below, according to the maximum output power of the communications equipment				
Separation Distance According to Frequency of Transmitter (Meters)				
Rated Maximum Output Power of Transmitter (Watts)	150 kHz to 80 MHz Outside ISM Bands	150 kHz to 80 MHz in ISM Bands $d = \left[\frac{12}{V_2} \right] \sqrt{P}$	80 MHz to 800 MHz $d = \left[\frac{12}{E_1} \right] \sqrt{P}$	800 MHz to 2.5 GHz $d = \left[\frac{23}{E_1} \right] \sqrt{P}$
0.01	0.12	0.12	0.12	0.23
0.1	0.38	0.38	0.38	0.74
1	1.20	1.20	1.20	2.30
10	3.80	3.80	3.79	7.40
100	12.00	12.00	12.00	23.00
For transmitters rated at a maximum output power not listed above, the recommended separation distance d in meters (m) can be determined using the equation applicable to the frequency of the transmitter, where P is the maximum output power rating of the transmitter in watts (W) according to the transmitter manufacturer.				
NOTE 1 At 80 MHz and 800 MHz, the separation distance for the higher frequency range applies.				
NOTE 2 The ISM (industrial, scientific and medical) bands between 150 kHz and 80 MHz are 6.765 MHz to 6.795 MHz; 13.553 MHz to 13.567 MHz; 26.957 MHz to 27.283 MHz; and 40.66 MHz to 40.70 MHz.				
NOTE 3 An additional factor of 10/3 is used in calculating the recommended separation distance for transmitters in the ISM frequency bands between 150 kHz and 80 MHz and in the frequency range 80 MHz to 2.5 GHz to decrease the likelihood that mobile/portable communications equipment could cause interference if it is inadvertently brought into patient areas.				
NOTE 4 These guidelines may not apply in all situations. Electromagnetic propagation is affected by absorption and reflection from structures, objects and people.				

Table 12-29: EMC Declaration - Recommended Distances

Pneumatic System

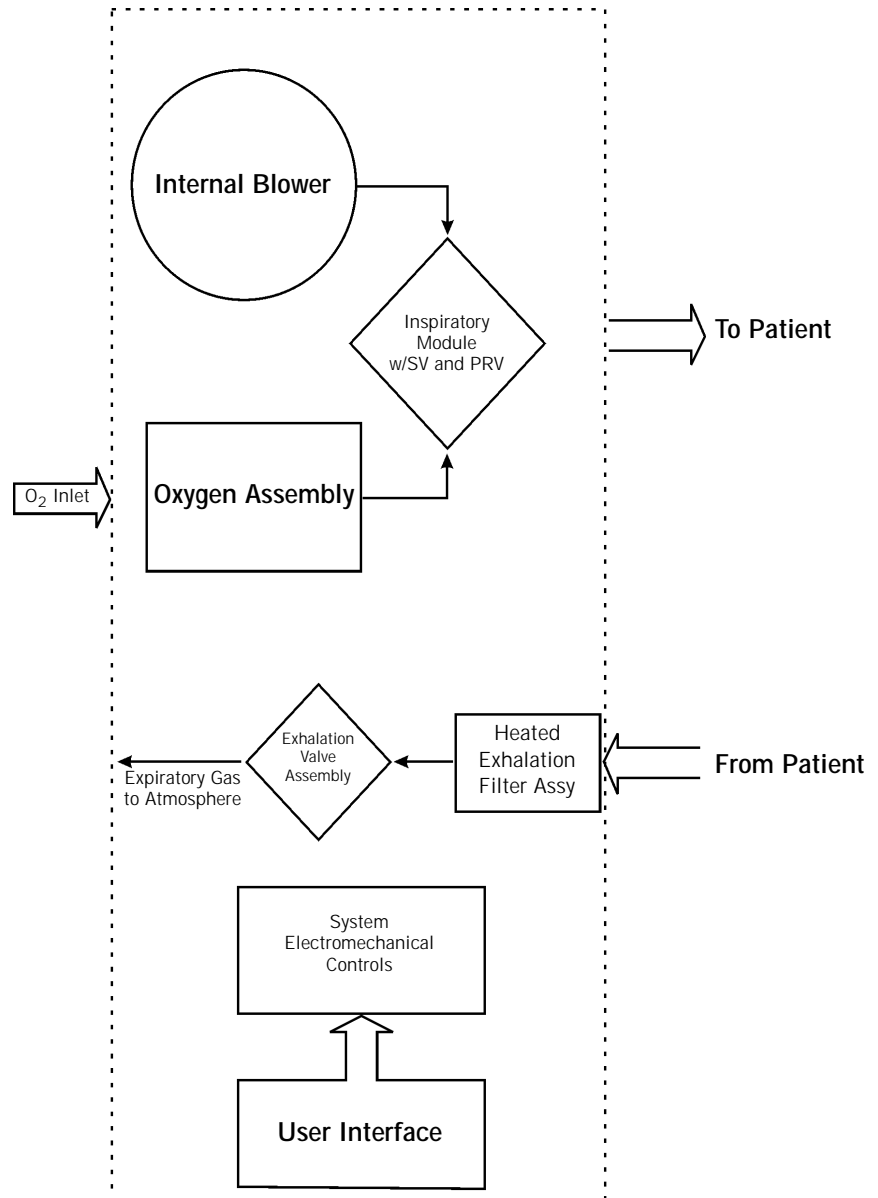

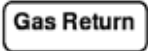
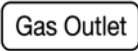





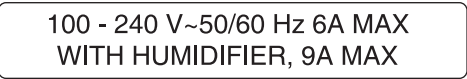
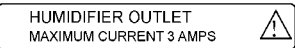



Figure 12-1: Pneumatic System

Labels

Ventilator Labels	
Label	Description
	On/Off Switch Label
	Heated Expiratory Filter Label
	Gas Return Label
	Gas Outlet Label
	Serial Port, Remote Alarm Nurse Call, parallel printer port Label
	Keep Covered Label
	Analog port
	Potential Equalization Connector
	DC Battery Connection Label
	AC Power Label
	Humidifier Outlet Label
	Power Switch on Front Label
	Circuit Breakers Label

Ventilator Labels (Continued)

Oxygen Inlet Label

CAUTION:
Do not crimp, kink or knot oxygen gas supply hose. Oxygen inlet pressure range must be 40 - 90 psig, 276 - 621 kPa (200 LPM min.)

Emergency Air Intake Label

WARNING:
Emergency Air Intake

Do Not Obstruct!

Cooling Inlet Label

Caution: Do Not Block Cooling Inlet

Date of Manufacture/Manufacturer Label

 **Respironics California, Inc.**
Carlsbad, CA USA
Model: V200
P/N: XXXXXXXX
S/N: XXXXXXXXXX
MM/YYYY

Manufacturer Label

 Respironics California, Inc. Authorized Representative:
2271 Cosmos Court Carlsbad, CA 92011
Respironics Deutschland GmbH
Gewerbeallee 17 D-82211 Herrsching Germany
0086     
MADE IN THE U.S.A.
Covered by one or more of the following patents: 6,543,449. Other patents pending.
CLASS 1
IPX 1

Mercury disposal warning label

WARNING: Lamps in display contain mercury - Dispose of properly.

Warning Label

DANGER: Explosion Hazard. Do not use in the presence of flammable anesthetics.
WARNING: Do not disassemble. Refer servicing to qualified personnel. 
CAUTION: Read and understand operating instructions prior to use.
CAUTION: Federal law (USA) restricts this device to sale by or use on the order of a physician

Attention Label



Hot and Attention Label

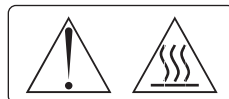

Ventilator Labels (Continued)

Air Intake Label

WARNING: Air Intake - Do Not Obstruct!

Protective Earth (Ground) Label

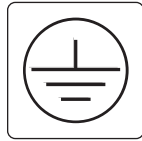

Chapter 13. Options and Accessories

Introduction

This chapter lists and describes the Respironics V200 ventilator options and accessories.

Options and Accessories		
	Page Reference	Part Number
Software Options		
Communications	13-27	1010525
Flow-Trak	13-83	1019026
Graphics	13-19	1003772 ^a
Neonatal	13-97	1016851
Respiratory profile monitor interface (NICO-Esprit Interface)	13-87	1022488
Respiratory Mechanics	13-51	1006600
RS-232 Communications 2	13-39	1015725
Trending	13-69	1013446
Speaking Mode	13-103	1046805
Auto-Trak	13-117	1061450
Hardware Accessories		
AC Power Cord		1001832 ^a
Backup Battery		1059956
External Battery	13-6	1059955
Vuelink Cable		1006912
V200 Cart		1060495
Flex Arm Assembly		1003781
Flex Arm Bracket		1002497
Humidifier Bracket Kit, Hudson CONCHATHERM IV		1061390
Humidifier Mounting Adapter, Hudson CONCHATHERM Series III/IV		1002231
O ₂ Cylinder Holder Kit		1060815
O ₂ High Pressure Hose		1001664 ^a
O ₂ Manifold	13-13	1060785
O ₂ Sensor Kit	13-3	1002541
O ₂ Sensor Kit, PVC	13-3	1032037
Respiratory Profile Monitor Mounting Kit		1060784
RS-232 serial communications 3' cable (NICO-Esprit)		1018292

Table 13-1: Options and Accessories (Sheet 1 of 2)

Options and Accessories (Continued)	
Remote Alarm Cable Kit (Normally Open Protocol)	1003741
Remote Alarm Cable Kit (Normally Closed Protocol)	1003742
Remote Alarm Cable Kit — Respirationics (LifeCare)	1003743
Test Lung	1001737
Reusable Items	
Reusable Exhalation Bacteria Filter Omni (Single)	1002970
Reusable Inspiratory Bacteria Filter (Single)	1003847
Reusable Patient Circuit Kit, Adult	1003058
Kit includes:	
1 - Reusable Inspiratory Bacteria Filter	1003847
1 - Reusable Exhalation Bacteria Filter	1002970
2 - Water Traps	1003648
2 - Coupling, Straight Silicone	500-1000-43
Reusable Patient Circuit Kit, Pediatric	1003059
Kit includes:	
1 - Reusable Inspiratory Bacteria Filter	1003847
1 - Reusable Exhalation Bacteria Filter	1002970
2 - Water Traps	1003648
2 - Coupling, Straight Silicone	500-1000-43
Reusable Vial System, Water Collection	1021884
Disposable Items	
Disposable Exhalation Bacteria Filter (pkg of 12)	1002240
Disposable Inspiratory Bacteria Filter (Single)	1014047
Disposable Inspiratory Bacteria Filter (pkg of 10)	0342077
Disposable Patient Circuit, Adult	1003698 ^a
Kit includes:	
1 - Disposable Inspiratory Bacteria Filter	1014047
1 - Disposable Exhalation Bacteria Filter	1002240
2 - Coupling, Straight Silicone	500-1000-43
Disposable Vial System, Water Collection	1006241
Documentation	
Respirationics V200 Operator's Manual CD	1062476
Respirationics V200 Operator's Manual (included on CD)	1057983 ^b
Respirationics V200 Service Manual CD	1062500
Respirationics V200 Operator's Manual (included on CD)	580-1000-02

Table 13-1: Options and Accessories (Sheet 2 of 2)

a. The part number varies with the country to which the ventilator is delivered.

b. The part number varies by language.

WARNING: The use of accessories, cables, and transducers other than those specified may result in increased EM emissions or decreased immunity of the system.

Oxygen Sensor Option

The optional Oxygen sensor (O₂ sensor) may be installed to allow monitoring of delivered O₂ to the inspiratory limb of the patient circuit. The ventilator will accept the MSA MiniOX[®] O₂ and Analytical Industries Inc. sensors, P/N 1001454.

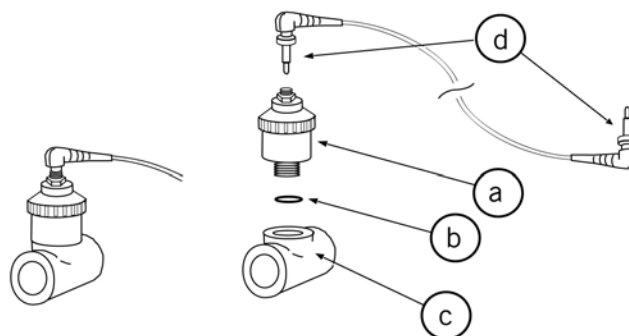

Figure 13-1: O₂ Sensor exploded view

Assemble O₂ Sensor

Refer to Figure 13-1 for the following instructions.

MSA MiniOX O₂

1. Remove the O₂ sensor (a) from the package. Discard the o-ring and adapter (not shown) provided with the sensor.
2. Place flat gasket (b) into the threaded hole of the O₂ Sensor Tee (c).
3. Screw the O₂ sensor (b) into the O₂ sensor tee (c).
4. Insert one end of the O₂ sensor cord (d) into ventilator. Insert other end of O₂ sensor cord (d) into the sensor. Fasten each end with knurled collars.

Analytical Industries Inc.

1. Remove the O₂ sensor (a) from the package.
2. Screw the O₂ sensor (b) into the O₂ sensor tee (c).
3. Insert one end of the O₂ sensor cord (d) into ventilator. Insert other end of O₂ sensor cord (d) into the sensor. Fasten each end with knurled collars.

Attaching the Sensor to the Ventilator

The O₂ sensor attaches to the gas outlet port located below the front panel on the ventilator's lower right corner.

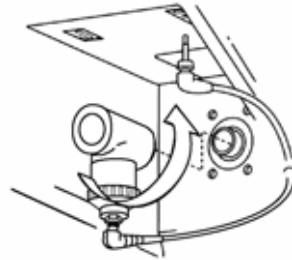

Figure 13-2: O₂ Sensor Orientation

1. Rotate the sensor assembly so that the sensor is pointing up.

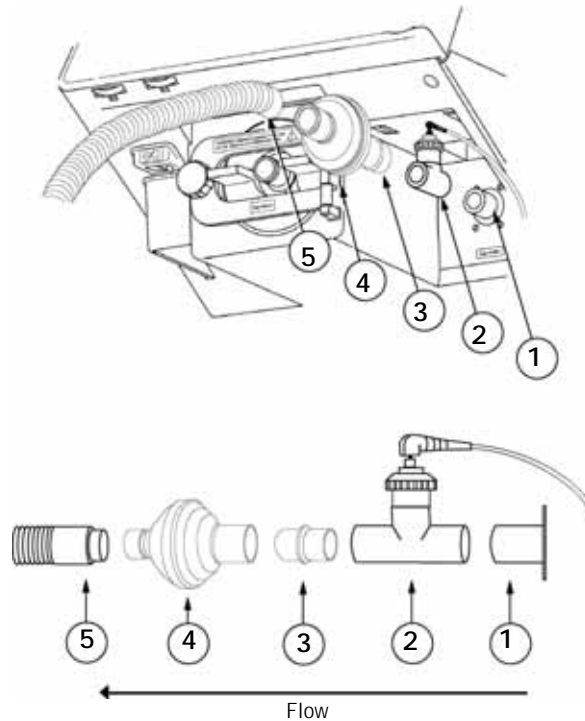

Figure 13-3: Connecting O₂ Sensor and Patient Circuit

2. Connect the T-fitting (2) to the gas outlet port (1).
3. Insert the inspiratory bacteria filter (4) into the T-fitting (2) using the 22mm connector (3) if necessary. Some bacteria filters provide an arrow or other mark to indicate the direction of flow. The flow indicator should be pointed away from the ventilator, toward the patient circuit connection.

CAUTION: To prevent contamination of the O₂ sensor, always locate it between the ventilator gas output port and the inspiratory bacteria filter.

4. Connect inspiratory limb of patient circuit (5) to bacteria filter (4).
5. Ensure that all connections are tight.

NOTE:	Record O ₂ sensor manufacturing or warranty numbers and installation date for future reference.
NOTE:	To ensure accurate O ₂ monitoring, check O ₂ sensors periodically and replace as per manufacturer specification.
NOTE:	Sensor performance and expected operating life information is outlined in the sensor manufacturer's instructions for use. Thoroughly review all O ₂ sensor instructions prior to installation and use with the ventilator.
NOTE:	O ₂ sensor calibration is performed during EST. If recalibration of the O ₂ sensor is required, follow the instructions for "Extended Self Test (EST)" in Chapter 11.

Warranty

Respironics warrants the O₂ sensor to be free from defects in material and workmanship for a period of one year from the date of purchase, provided that the unit is operated under conditions of normal use as described in this operator's manual.

At its discretion, Respironics will make replacements, repairs, or issue credits for equipment or parts that are found to be defective.

O₂ Sensor Tee

The External Oxygen Sensor Adapters (P/Ns 8-100498 and 1020380) are also referred to as O₂ Sensor Tees. The PVC adapter is gray, the Ultem® is clear with an amber tint, and both are compatible with the MSA and Analytical Industries External Oxygen Sensors. Both tees are compatible with all ventilators.

Both tees have 22mm female/male connections; therefore the 22mm male-male adapter (P/N 1002505) is not needed when using this adapter.

CAUTION: PVC O₂ (P/N 8-100498-00) and Ultem® (P/N 1020380) Sensor Tees cannot be autoclaved or chemically disinfected.



Figure 13-4: Sensor Tee

(This page is intentionally blank.)

External Battery Option



The V200 External Battery is designed for use with a Respironics V200 Ventilator equipped with a backup battery.



Figure 13-5: Ventilator with External Battery Installed

Installation

Contact Respirationics Customer Service at 1-800-345-6443 to arrange installation or refer to the installation section of the Ventilator External Battery Service Instructions (1013569).

WARNING: Do not lift the external battery. If the battery needs to be removed from the cart, contact Respirationics Customer Service at 1-800-345-6443.

Power Consumption Sequence

When AC power becomes unavailable, the ventilator consumes power from the battery systems as follows:

- **With the external battery installed and turned ON and backup battery installed:** External battery power is consumed first until depleted. Backup battery power is then used until depleted. An audible alarm sounds when the backup battery is in use. The ventilator will not operate when both batteries are depleted.
- **With backup battery installed only:** Backup battery power is used until depleted. An audible alarm sounds when the backup battery is in use. The ventilator will not operate when the battery is depleted.

AC power can be restored to the ventilator at any time during battery use. When AC power is restored the ventilator consumes AC power only, and both batteries begin recharging. (See "Battery Charging" on page 13-10).

External Battery/ Backup Battery Operation

The external battery must be turned ON in order for the external battery to be used. Make sure the ON/OFF switch located on the external battery (Figure 13-6) is in the ON (I) position. When AC power becomes unavailable, the ventilator automatically switches to external battery operation without interruption in ventilation. When the external battery is depleted, the ventilator automatically switches to backup battery power.

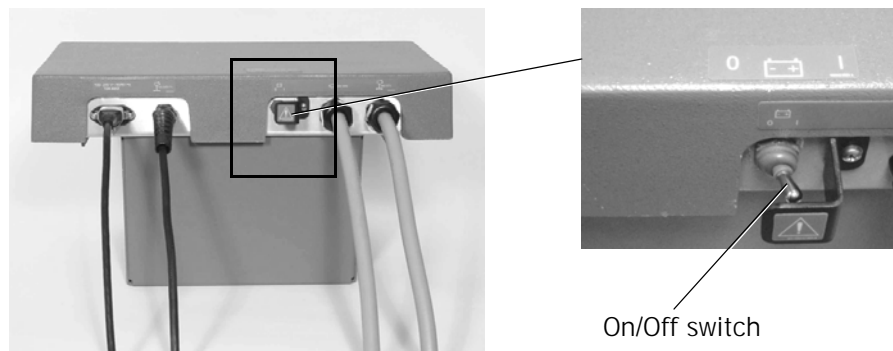





Figure 13-6: External Battery On/Off Switch

WARNING: The external battery ON/OFF switch must be in the ON (I) position to ensure operation during a power failure. When this switch is in the OFF (0) position, the external battery is disabled. Switch off ONLY when connecting or disconnecting cables or when the ventilator or external battery is in storage for more than 2 weeks and is not connected to AC power.

When the external battery is in use, the *External Battery* indicator () is continuously illuminated. If the ventilator switches to backup battery operation, the *In Use* (text version of the front panel) or  (symbol version of the front panel) indicator illuminates, and the ventilator sounds an audible alarm every 60 seconds (the alarm cannot be reset or silenced). When approximately five minutes of backup battery power remains, the ventilator sounds a high urgency audible alarm (a repeating sequence of five tones) that cannot be reset, and the red *Low* (text version of the front panel) or  (symbol version of the front panel) and *Alarm High* indicators flash.

WARNING: When the ventilator Battery Low indicator flashes red, less than five minutes of battery power remains. Immediately connect AC power or provide an alternate source of ventilation.

Battery Capacity

The external battery is used with the backup battery. Under optimal running conditions, both batteries together can operate the ventilator for up to four hours. However, ventilator power consumption varies according to environmental conditions and ventilator settings. Battery capacity varies with the age and charge level of the battery. The external battery should be kept fully charged to ensure maximum capacity when needed.

CAUTION: Battery operating life depends on battery age and number of discharges and recharges. Over time the battery degenerates and provides less operating time per charge than a fully-charged new battery. Use a Respirationics External Battery P/N 1059955 only.

Battery Charging

The external battery is designed to be recharged only as described here. Do not use any other method to recharge the battery.

In order for the external battery to charge, the system must be connected to a viable AC power source. The ventilator can be operating or in standby mode. A new external battery fully charges within 15 hours. The time required to recharge depends on the original charge level of the battery.

When the external battery is connected to a functioning AC power source, the *MAINS* indicator located on the front of the ventilator is lit and the green AC indicator on the external battery is lit (Figure 13-7).

The yellow "Battery Charging" indicator on the external battery has the following indication modes:

- Continuous ON - Battery is in deep charge mode
- Flashing - Battery is approaching full charge
- Off-Battery is fully charged

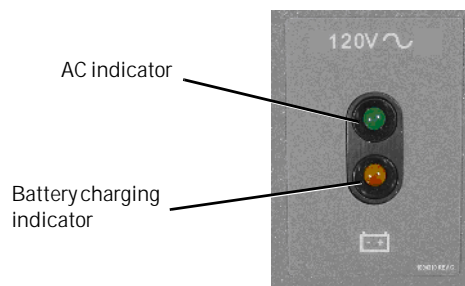

Figure 13-7: External Battery Indicator Lights

If the external battery does not reach full charge within 15 hours, contact Respirationics Customer Service at 1-800-345-6443.

CAUTION: The External Battery is designed to recharge only as described here. Do not use any other method to recharge the External Battery.

CAUTION: If the ventilator is expected to be stored for more than 2 weeks, the external battery ON/OFF switch should be set to the OFF (O) position to avoid discharging the external battery. This switch must be placed in the ON (I) position when the ventilator is removed from storage and returned to use.

Testing

The external battery should be tested during the regular preventative maintenance cycle of the ventilator or as required by your institutional procedures. Perform the External Battery Verification Procedure included in the External Battery Service Instructions (1013569).

Battery Specifications

Part Number:	1059955
Model:	V200 External Battery
Type:	Lead Acid*
Output:	24 V, 33AH
Class:	1
Recharge Time:	~ 15 hours
Charge Hold:	~ 14 days at 20 C
Storage Conditions:	-20 C to 60 C at 10%-95% relative humidity

*Batteries are considered hazardous waste and must be disposed of according to local regulations. It is unlawful to dispose of these batteries except through a regionally approved recycling center.

For additional information, contact Respironics Customer Service at 1-800-345-6443.

Warranty

Respironics warrants the Respironics V200 external battery to be free from defects in material and workmanship for a period of twelve months from the date of installation, provided that the unit is operated under conditions of normal use as described in this operator's manual.

At its discretion, Respironics will make replacements, repairs, or issue credits for equipment or parts that are found to be defective.

This warranty does not apply to any unit or individual parts which have been repaired or altered in any way that, in Respironics judgment, affect its ability or reliability, or which has been subjected to misuse, negligence, abuse, or accident.

Unauthorized service and/or failure to perform periodic maintenance may void this warranty.

This warranty does not cover damage that may occur in shipment.

This warranty takes precedence over all other warranties, expressed or implied. This warranty also takes precedence over all other obligations or liabilities on the part of Respironics including, but not limited to, contingent or consequential damages, such as costs of repairing or replacing other property which may be damaged as a direct result of Respironics V200 Ventilator operation.

This warranty, and the rights and obligations described herein, is construed under and governed by the laws of the State of California, U.S.A.

Oxygen Manifold Option

The oxygen manifold allows two O₂ cylinders and one wall oxygen supply line to be used as inputs to the ventilator. Each of the three inlets has a check-valve that prevents pressure loss when disconnecting from the wall or cylinders. This allows quick, easy transfer between oxygen supplies without interruption of flow. Easy transfer of oxygen supply facilitates patient transport within the facility and allows replacement of one cylinder while operating from the other.

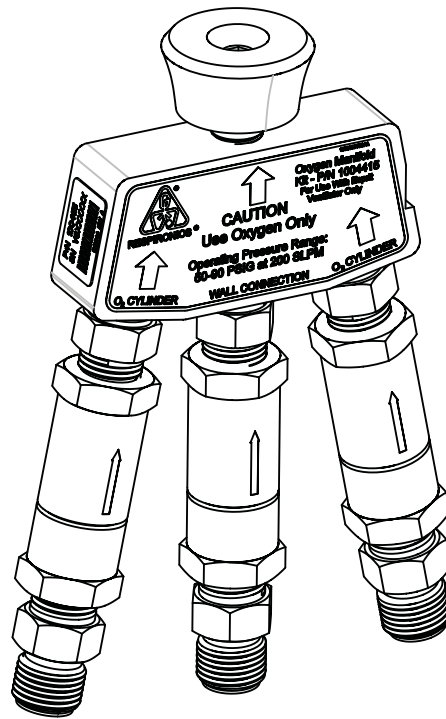

Figure 13-8: Oxygen Manifold Assembly

Kit Contents

- (1) Oxygen Manifold Assembly
- (1) Oxygen Manifold Bracket with Grommet
- (2) 24-inch Medical Hose Assemblies - Oxygen
- (1) 4.0mm Allen wrench
- (2) M6 x 10mm BUTTON HEAD SCREWS, SOC CAP

WARNING: The Oxygen Manifold is for oxygen use only.

WARNING: Maximum inlet pressure: 90 PSIG
Minimum inlet pressure: 50 PSIG at 200 SLPM

WARNING: Keep all hoses within the limits of the ventilator footprint to prevent a tripping or snag hazard.

CAUTION: Use this kit with the Respironics V200 Ventilator only.

CAUTION: Do not use the oxygen manifold or oxygen hoses to move the ventilator.

Assembly Instructions

1. Lock the front wheels of the ventilator.

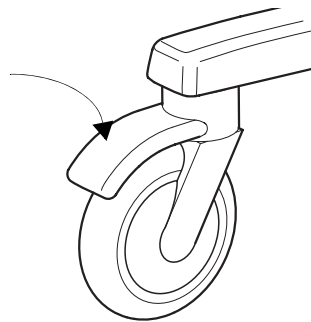

Figure 13-9: Locking Ventilator Wheel

2. Attach the oxygen manifold assembly to the ventilator by threading the adapter fitting onto the oxygen inlet elbow fitting. Using the manifold for leverage, rotate the oxygen inlet elbow fitting until the manifold assembly is vertical, as shown in Figure 13-10.

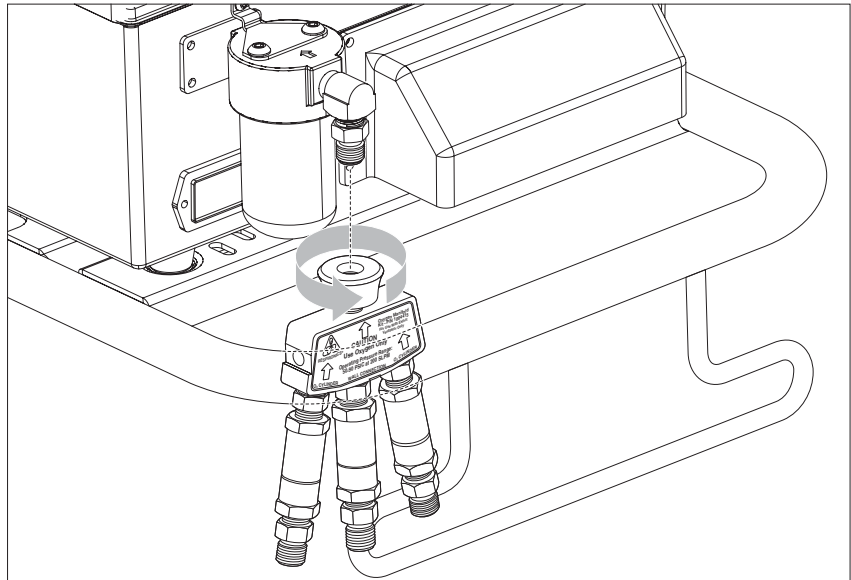

Figure 13-10: Ventilator With Oxygen Manifold

3. Position the manifold support bracket so that the Wall O₂ connection of the manifold fits snugly into the manifold support bracket grommet. Using the Allen wrench, attach the bracket to the cart using the two M6 x 10mm screws.

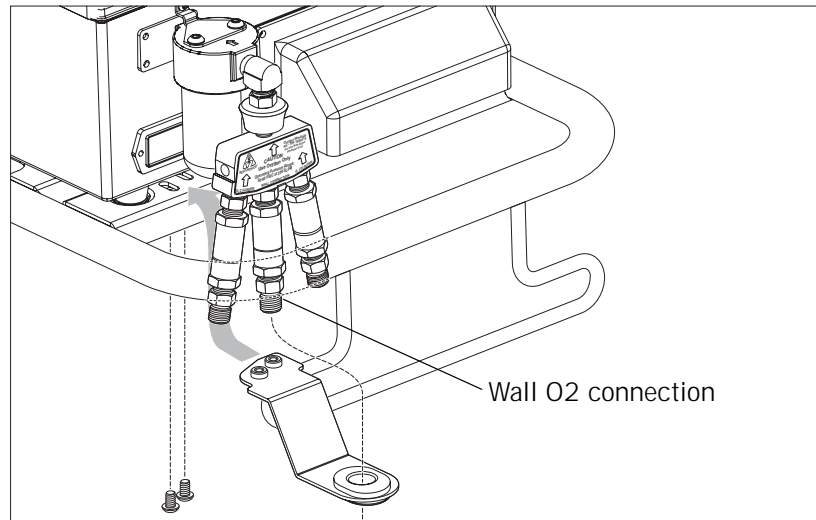

Figure 13-11: Attaching Manifold Support Bracket

4. If you will be using O₂ cylinders, connect either or both of the oxygen hoses from the O₂ cylinders to the left and right inlets of the oxygen manifold assembly. These inlets are marked "O₂ Cylinder".

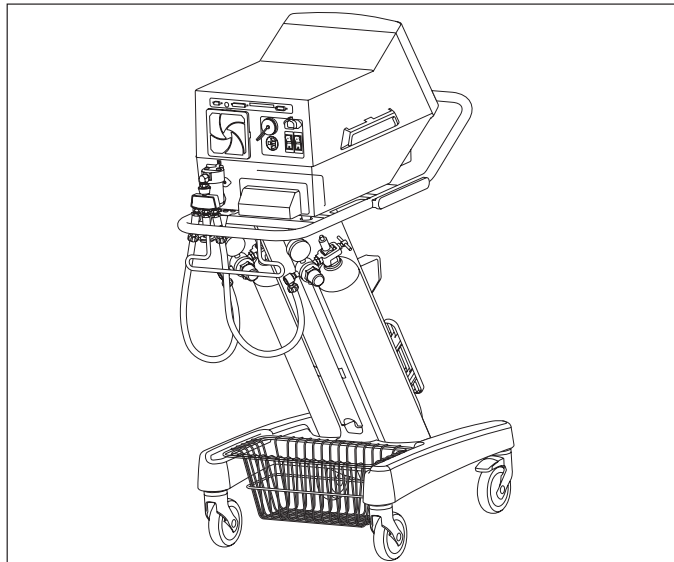

Figure 13-12: Completed Manifold Assembly

5. When using oxygen from a wall supply, attach a wall oxygen hose (not included) to the center inlet of the oxygen manifold assembly.

Replacement Parts:

The following replacement parts can be ordered from Respirationics:

- Check Valve Assembly (PN 1007190)
- 24-inch Medical Hose Assemblies - Oxygen (PN 1006655)
- Bracket and Hardware Kit (PN 1062294)

Using the Manifold

To Use Wall Supply Oxygen

Connect the wall oxygen supply to the manifold. Close the O₂ cylinder valves.

Oxygen is delivered to the ventilator from all sources that are active. Therefore, if the O₂ cylinder valves are open while oxygen is being delivered from the wall supply, the cylinders can be depleted of oxygen. To avoid depleting the O₂ cylinders, shut off the cylinder valves when using the wall oxygen supply.

WARNING: If using wall oxygen supply, close the O₂ cylinder valves to avoid depleting the cylinders.

To Use O₂ Cylinders

Open the O₂ cylinder valves and disconnect the wall oxygen supply.

Transport Use

When preparing for intra-facility transport use, first open the O₂ cylinder valves and then disconnect the wall oxygen supply. When transport is complete, reconnect the wall oxygen supply and then close the O₂ cylinder valves.

(This page is intentionally blank.)

Graphics

The Graphics software enhances the display screens with graphical data of the patient's flow, pressure, and volume. The Graphics software offers a choice of screens:

- The **Waveform screen** displays two windows displaying pressure, flow, or volume within a specified time scale.
- The **Loops screen** displays three windows: a waveform window (pressure, flow, or volume), a flow/volume loop window, and a pressure/volume loop window.

Graphics is available in all ventilation types.

Starting Graphics

To enter the graphics screens, press the Graphics icon button in the lower right corner of the screen (Figure 13-13).

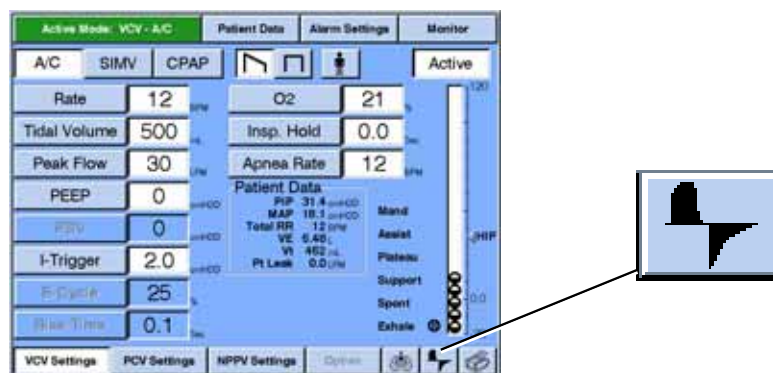

Figure 13-13: VCV Settings Screen and the Graphics Icon Button

Using Graphics

Press the WAVEFORMS button to view two waveforms, or press the LOOPS button to view one waveform and two loops (Figure 13-14 shows a Waveforms screen).

1. For each waveform, press the FLOW, PRESSURE, or VOLUME button.
2. Press the 7 sec, 14 sec, or 21 sec button to select the waveforms time scale.

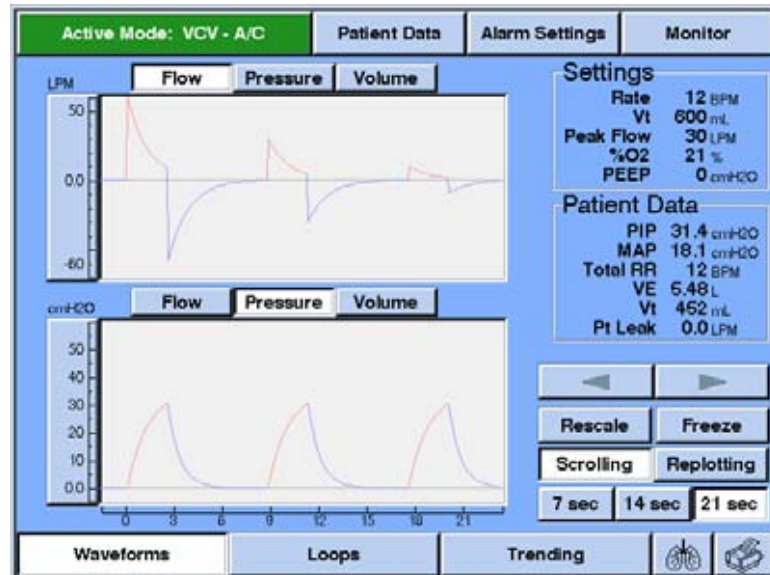

Figure 13-14: Waveform Screens

Replotting and Scrolling

You can select one of two plotting methods for waveforms:

- **Replotting** selects a waveform that is drawn from left to right, then clears and restarts from the left edge (similar to an oscilloscope).
- **Scrolling** selects a waveform that is drawn from left to right, then continuously shifts to the left to display the most recent data at the right edge of the screen (similar to a stripchart).

Rescaling the Display

Press RESCALE (Figure 13-15) to allow software to adjust the vertical scales for waveforms and vertical and horizontal scales for loops. Rescaling is available for waveforms and loops, in normal and during Freeze operation. For optimum viewing, press RESCALE at the *end of exhalation*.

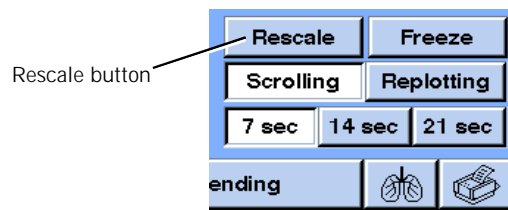

Figure 13-15: Rescale Button

Figure 13-16 shows waveforms before and after rescaling.

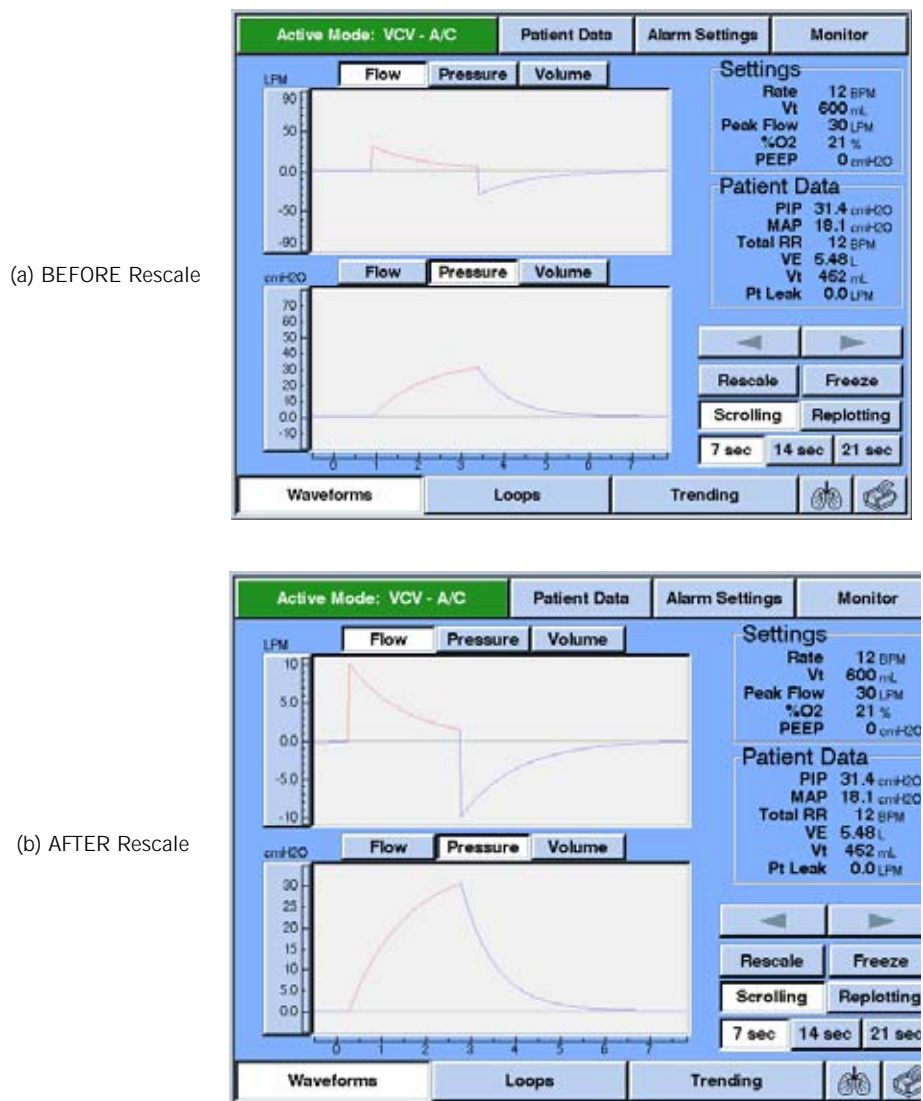

Figure 13-16: Waveforms Screen (a) Before and (b) After Rescale

Follow these steps to change scales manually:

1. Touch the upper or lower portion of the scale you want to change.
2. Press the INCREASE or DECREASE bar or turn the knob to adjust the scale range.
3. Press ACCEPT (onscreen button or offscreen key).

Figure 13-17 shows an example of how to adjust an upper scale limit.

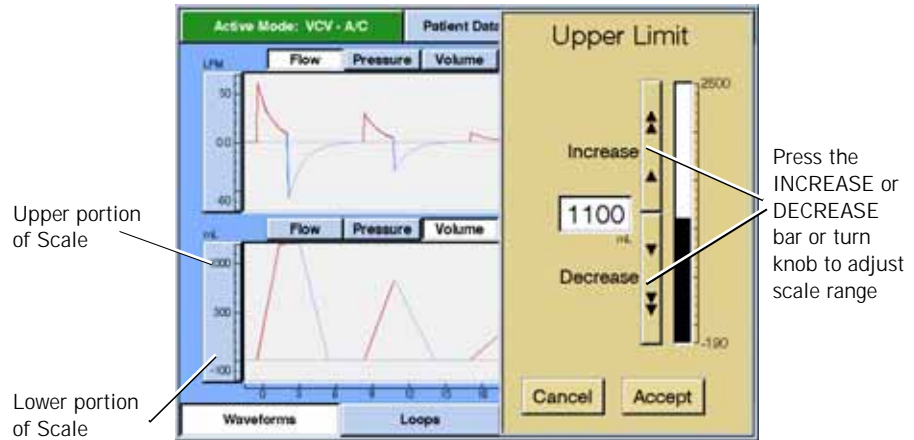

Figure 13-17: Manually Adjusting a Scale

Freeze Feature

The FREEZE button (Figure 13-18) pauses the Waveforms or Loops windows for extended viewing when the waveform window is full.

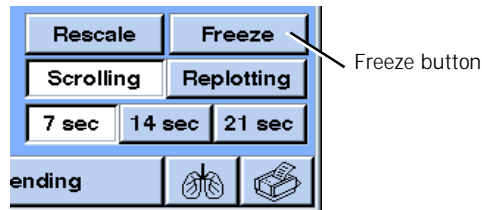

Figure 13-18: Freeze Button

Once the Freeze feature is in effect, each graphics window shows numeric data for the cursor position on the waveform display. To adjust the cursor position (and select which breath appears on the loops windows) and view the exact flow/pressure and volume at different points of each breath, press the arrow button or turn the knob. Press the CONTINUE button to unfreeze graphics. Figure 13-19 shows a frozen Loops display.

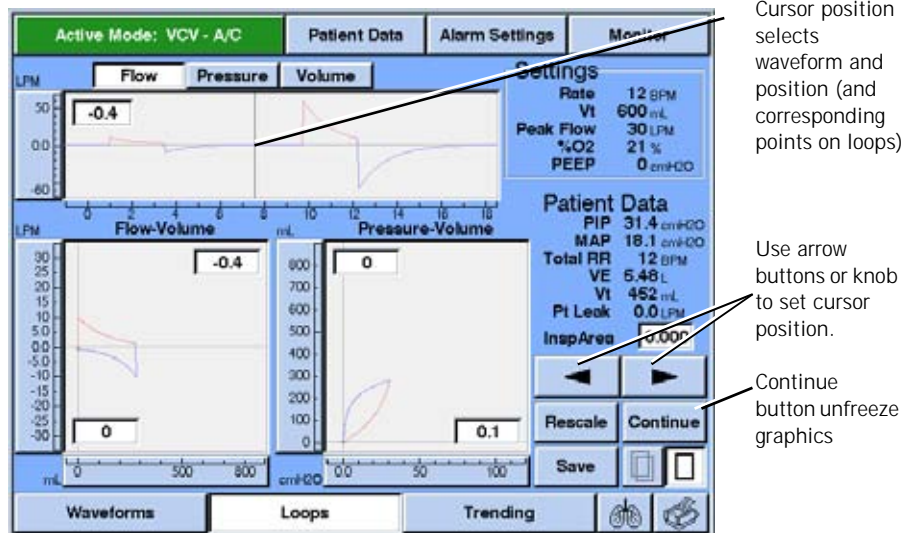

Figure 13-19: Frozen Loops Display with Numeric Data Windows

Save and Overlay Features

Follow these steps to save a frozen loop for later reference against future data (for example, before and after bronchodilator therapy):

1. Press the FREEZE button to save the Loops screen.
2. Use the arrow buttons or knob to select a breath.
3. Press the SAVE button.
4. Press CONTINUE to unfreeze the screen.
5. Press the OVERLAY button to superimpose a gray image of the saved loop on the current display (the Overlay feature works on frozen or unfrozen displays).
6. Press the SINGLE VIEW button to view current graphics without the saved loops.

Figure 13-20 illustrates the Overlay feature

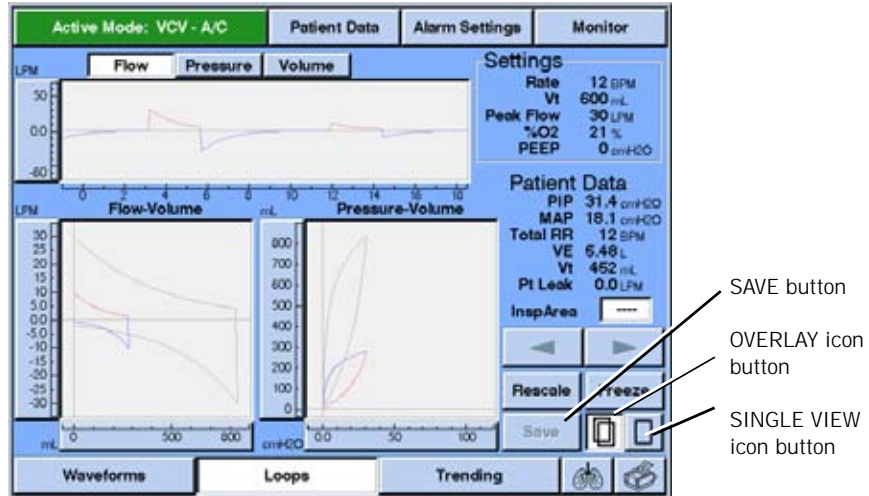

Figure 13-20: Loops Display with Overlay Feature Active

Inspiratory Area

The Loops screen includes a window for the inspiratory area (Figure 13-21F). This window displays a numeric value that represents the ventilator imposed work of breathing, and is only calculated and displayed for a frozen loop. If the ventilator is supporting the entire breath, the Insp Area window displays "0.000". If the Insp Area window shows dashes ("----"), the ventilator is not calculating inspiratory area because the loops are not frozen.

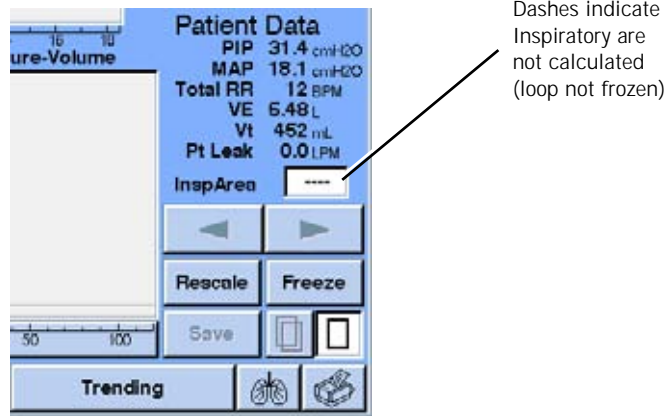

Figure 13-21: Loops Screen with Inspiratory Area Window

Alarms During Graphics

If an alarm occurs during Graphics, an Alerts window (Figure 13-22) lists the active alarms.

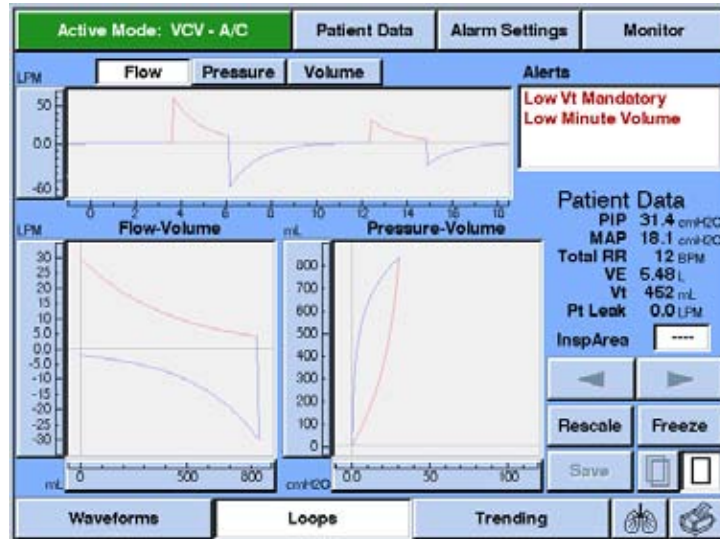

Figure 13-22: Graphics Screen with Alerts window

(This page is intentionally blank.)

Communications Option (Com1)

The Communications option allows the Respironics V200 Ventilator to:

- Print out the ventilator's screen contents.
- Communicate with a Philips/Agilent/HP VueLink module.
- Connect another device, such as a chart recorder, via the analog output port.

Using the Communications option does not affect ventilation or monitoring. The Communications option button (a printer icon) is displayed in the lower right corner of the screen (Figure 13-23). The printer icon is gray if the Communications option is not installed, not available, or a print is in progress.

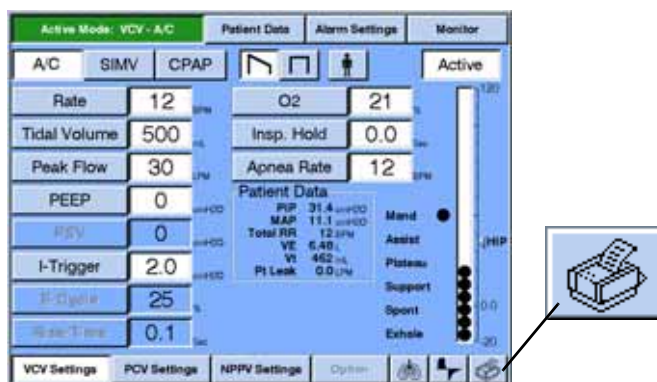

Figure 13-23: Communications-Print Option Button (Printer Icon)

Print Screen

The Communications-Print option allows the ventilator to print out the screen contents to an attached printer. The printer must be connected to the ventilator's parallel port and use PCL3 or PCL5 printer language.

Connecting to a Printer

Figure 13-24 shows how to connect a ventilator to a printer. Use a standard 25-pin parallel printer cable to connect the ventilator to the printer.

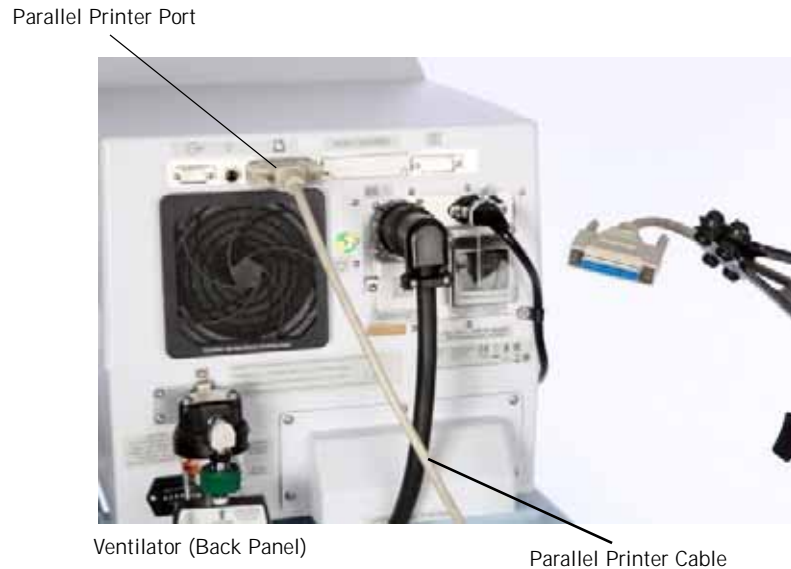

Figure 13-24: Connecting the Ventilator to a Printer

Printing a Screen

To print a screen, touch the printer icon in the lower right corner of the screen.

While the ventilator processes the print screen request, the screen freezes (typical freeze time of 30-60 seconds, depending on ventilator settings) and the printer icon turns gray. Ventilation and monitoring continue uninterrupted although the screen does not update during this time.

Certain screens and popup menus cover the printer icon and are not available for printing. The print screen function is also not available any other time the printer icon is gray.

Canceling a Print Screen Request

To cancel a print screen request (e.g. during an alarm), touch the frozen screen at any location. Any contact with the touch screen (including the gray printer icon) while the printer icon is gray cancels the print in progress.

Print Screen Messages

Table 13-2 summarizes print screen messages that can occur. The actual message displayed depends on the connected printer. For example, if a printer turns itself offline when it is out of paper, the error message may indicate that the printer is offline rather than out of paper.

Message	Corrective action
Print aborted: Printer paper empty	Load paper and retry print screen.
Print aborted: Printer offline	Check printer, cycle power to printer, retry print screen.
Print aborted: Printer error	Check printer, retry print screen if printer is busy, cycle power to printer.
Print canceled: Touching the screen while a print is in progress will cancel the Print.	Avoid touching the screen while the printer icon is dimmed unless intending to cancel the print in progress.
Print unavailable: Print in progress	None required: retry print screen when current print is complete.

Table 13-2: Print Screen Messages and Corrective Actions

VueLink Compatibility

The Communications option allows the ventilator to communicate with a Philips/Agilent/HP Component Monitoring System (CMS) via the VueLink module M1032A #A02. Once the ventilator and VueLink module are connected, the VueLink module automatically updates the monitor's screen to display ventilator parameters, provided the CMS is configured for an Open Interface device. For more information on configuring, see "Configuring the VueLink Module". Displayed parameters are determined by the ventilation mode selected on the ventilator. Any time the mode of ventilation is changed, the CMS will revert to the Standard Parameter Interface (SPI) screen. Pressing the button on the VueLink Module will then activate the CMS screen with more ventilator information.

If any alarms are active, alarm messages are also displayed. The CMS can only display one patient alarm and one ventilator alarm (called an inop on the CMS) at a time. Alarms are listed in order of priority as defined by the ventilator.

Data displayed on the VueLink system is for reference purposes only. Decisions for patient care should not be based solely on the data displayed on the VueLink system.

Connecting to the VueLink Module

The Communications option enables the ventilator to connect to a VueLink module, using:

- a VueLink cable (Respironics part number 1006912).
- a VueLink module M1032A #A02 (for connection to devices using the open device driver; contact Philips sales representative for ordering information).

Figure 13-25 shows how to connect a ventilator to a VueLink module.

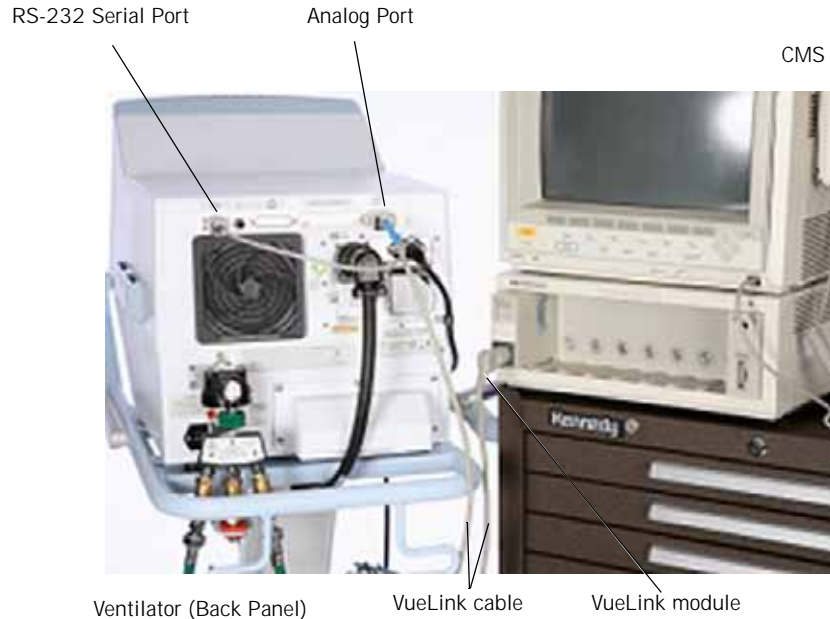

Figure 13-25: Connecting a Ventilator to a VueLink Module

Configuring the VueLink Module

A VueLink Ventilator Module M1032A #A02, is required for communication with the ventilator. The VueLink Module can communicate to three different protocols for external devices: VueLink Interface, Analog Interface, or VueLink Open Interface. The ventilator uses the VueLink Open Interface. Refer to the VueLink Handbook provided with the VueLink module for configuration directions for an Open Interface device. For reference purposes only, below are configuration directions from the "Agilent M1032A VueLink Module Handbook", Fourth Edition, 08/2000.

Configuration Overview

The VueLink Module must be configured during installation. Additional configuration will be required whenever a new device driver is preselected for availability in Monitoring Mode. The VueLink Module can be configured for up to three preselected device drivers.

Changing modes

The CMS must be in Configuration Mode to preselect devices. To do this, follow the steps below.

1. Turn on the ventilator in ventilation mode and connect it to a VueLink Module as shown in Figure 13-23.

2. Press "Monitor Setup" on a Standard Control Panel, or "Instrument Config." on a Classic Control Panel of the Component Monitoring System (CMS).
3. Highlight "Operating Modes" on the displayed window and press "Confirm". The current operating mode will appear in the task window (for example, "Operating Mode - Monitoring") along with a prompt for the password.
4. Enter the password, 1245. If the password is entered correctly, the "Change OpMode" key will be highlighted.
5. Press "Change OpMode" and select "Config" or "Monitor".
6. Press "Confirm".
 - a. If "Config" was selected in step 5, the display will become blank and the message "Config mode active - NO MONITORING!" will appear at the top of the screen. Continue with the "Preselecting Devices" section below.
 - b. If "Monitor" was selected in step 5, the VueLink system will begin to display data. Make sure that the LED next to "Open Device" is lit while in Monitoring mode to display ventilator data. If it is not lit, press the button on the VueLink Module, select "Open Interface" and press confirm. Pressing the button on the VueLink Module will then display the Standard Parameter Interface (SPI) screen. Pressing the VueLink Module button a second time will activate the ventilator screen with more information.

Preselecting Devices

Once in Configuration Mode, the Open device must be selected as one of the three preselected devices for the VueLink Ventilator Module. To do this, follow the steps below.

1. Press "Module Setup" or "Module Config" on the CMS.
2. Highlight "VENTILTR", "OPEN INTRFACE", OR "ESPRIT VENT" and press "Confirm".
3. Note: Only one of the above choices will be available at a time. The choice depends on how the module is already configured.
4. Verify "Prefer'd Module" is set to "Ventiltr" and choose whether device alarms should be Accepted or Ignored. Press "Module Config".
5. Highlight "Open Interface M1032-TU1AA" by using the arrow keys or pressing "Next Device".
6. Press "On/Off Preselect" if "On" is not already displayed beside this item.

NOTE: If "On/Off Preselect" is pressed a second time, the preselection is switched off.

NOTE: If there are already three devices preselected, one of the preselected devices must be turned "off" before adding a new one.

7. Press "Store Preselect", then "Confirm".
8. Attach the adhesive label containing "Open Device" to the VueLink module. The adhesive labels MUST be placed on the module in the same order as they appear in the Preselection Task Window.
9. When the above steps have been completed, change the CMS to Monitoring mode (see "Changing Modes").

For more information about the VueLink module, refer to the VueLink Module Handbook.

Information Sent to the VueLink System

Once the CMS detects that the ventilator is connected to the module, the CMS automatically displays ventilator parameters. The active type of ventilation determines what data the CMS displays. Table Figure 13-24 defines CMS displays and equivalent Respironics V200 Ventilator information.

Available on CareNet	CMS message	V200 equivalent	Comments
Volume control ventilation (VCV) parameters			
Mode and type of ventilation will always be displayed.			
X	AWF	Flow	Delivered flow.
X	AWP	Pressure	Delivered pressure.
	AWV	Volume	Delivered volume.
	sPSV	set PSV	Set pressure support ventilation.
	sPEEP	set PEEP	Set positive end expiratory pressure.
X	PIP	PIP	Measured peak inspiratory pressure.
	MnAwP	MAP	Measured mean airway pressure.
	Pplat	Pi End	Measured end inspiratory (plateau) pressure.
	PEEP	Pe End	Measured positive end expiratory pressure.
	SpMV	Spont VE	Measured spontaneous minute volume.
	sTV	set TV	Set tidal volume.
	MV	VE	Measured minute volume.
	PtLeak	Pt Leak	Estimated patient leak.
X	TV	Vt	Measured tidal volume.
	sFIO_2	set %O2	Set oxygen percentage (fractional inspired oxygen).

Options and Accessories

Available on CareNet	CMS message	V200 equivalent	Comments
X	FIO_2	%O2	Measured oxygen percentage (fractional inspired oxygen).
	sPKFI	set Peak Flow	Set peak flow.
	RiseTi	Rise Time	Set rise time.
	sAWRR	set Rate	Set (airway) respiratory rate.
	SpAWRR	Spont Rate	Measured spontaneous respiratory rate.
X	AWRR	Rate	Measured (airway) respiratory rate.
	F/TV	F/Vt	Ratio of frequency to tidal volume (rapid shallow breathing index).
Pressure control ventilation (PCV) parameters			
Mode and type of ventilation will always be displayed.			
X	AWF	Flow	Delivered flow.
X	AWP	Pressure	Delivered pressure.
	AWV	Volume	Delivered volume.
	sPSV	set PSV	Set pressure support ventilation.
	sPEEP	set PEEP	Set positive end expiratory pressure.
X	PIP	PIP	Measured peak inspiratory pressure.
	MnAwP	MAP	Measured mean airway pressure.
	Pplat	Pi End	Measured end inspiratory (plateau) pressure.
	PEEP	Pe End	Measured positive end expiratory pressure.
	sPVcP	set pressure	Set PCV pressure.
	SpMV	Spont VE	Measured spontaneous minute volume.
	MV	VE	Measured minute volume.
	PtLeak	Pt Leak	Estimated patient leak.
X	TV	Vt	Measured tidal volume.
	sFIO_2	set %O2	Set oxygen percentage (fractional inspired oxygen).
X	FIO_2	%O2	Measured oxygen percentage (fractional inspired oxygen).
	sInsTi	set I-Time	Set inspiratory time.
	RiseTi	Rise Time	Set rise time.
	sAWRR	set Rate	Set (airway) respiratory rate.
	SpAWRR	Spont Rate	Measured spontaneous respiratory rate.
X	AWRR	Rate	Measured (airway) respiratory rate.
	F/TV	F/Vt	Ratio of frequency to tidal volume (rapid shallow breathing index).
Noninvasive positive pressure ventilation (NPPV) parameters			
Mode and type of ventilation will always be displayed.			

Options and Accessories

Available on CareNet	CMS message	V200 equivalent	Comments
X	AWF	Flow	Delivered flow.
X	AWP	Pressure	Delivered pressure.
	AWV	Volume	Delivered volume.
	sIPAP	set IPAP	Set inspiratory positive airway pressure.
	sEPAP	set EPAP	Set expiratory positive airway pressure.
X	PIP	PIP	Measured peak inspiratory pressure.
	MnAwP	MAP	Measured mean airway pressure.
	Pplat	Pi End	Measured end inspiratory (plateau) pressure.
	SpMV	Spont VE	Measured spontaneous minute volume.
	MV	VE	Measured minute volume.
	PtLeak	Pt Leak	Estimated patient leak.
X	TV	Vt	Measured tidal volume.
	sFIO_2	set %O2	Set oxygen percentage (fractional inspired oxygen).
X	FIO_2	%O2	Measured oxygen percentage (fractional inspired oxygen).
	sInsTi	set I-Time	Set inspiratory time.
	RiseTi	Rise Time	Set rise time.
	sAWRR	set Rate	Set (airway) respiratory rate.
	SpAWRR	Spont Rate	Measured spontaneous respiratory rate.
X	AWRR	Rate	Measured (airway) respiratory rate.
	F/TV	F/Vt	Ratio of frequency to tidal volume (rapid shallow breathing index).
Alarms			
X	OCCL/Disconnect	Occlusion - SV Open/SM Occlusion/Disconnect	Occlusion, safety valve open. SM occlusion, disconnect. Red Alarm.
X	APNEA	Apnea	Apnea detected. Red Alarm.
X	LOW INSP PRESS	Low Insp. Pressure	Low inspiratory pressure limit violation. Red Alarm.
X	LOW O2 SUPPLY	Low O2 Supply	Oxygen supply below acceptable level. Red Alarm.
X	HIGH INSP PRESS	High Pressure	High pressure limit violation. Yellow Alarm.
X	LOW O2%	Low O2	Low measured oxygen concentration. Yellow Alarm.
X	LOW EXH MV	Low Minute Volume	Low exhaled minute volume. Yellow Alarm.

Options and Accessories

Available on CareNet	CMS message	V200 equivalent	Comments
X	HIGH LEAK RATE	High Leak Rate	High leak alarm limit violation. Yellow Alarm.
X	LOW EXH MAND TV	Low Vt Mandatory	Low mandatory tidal volume limit violation. Yellow Alarm.
X	HIGH EXH MV	High Minute Volume	High exhaled minute volume limit violation. Yellow Alarm.
X	LOW EXH TV	Low Tidal Volume	Low exhaled tidal volume limit violation. Yellow Alarm.
X	LOW EXH TV-SPNT	Low Vt Spontaneous	Low spontaneous tidal volume limit violation. Yellow Alarm.
X	INS TI TOO LONG	I-Time Too Long	Maximum inspiratory time exceeded. Yellow Alarm.
X	HIGH RESP RATE	High Respiratory Rate	High respiratory rate limit violation. Yellow Alarm.
X	HIGH O2%	High O2	High measured oxygen concentration. Yellow Alarm.
X	LOW PEEP/ EPAP	Low PEEP	Low PEEP limit violation. Yellow Alarm.
X	LOW PEEP/ EPAP	Low EPAP	Low EPAP limit violation. Yellow Alarm.
X	BACKUP BATT ON	Battery In Use indicator on ventilator front panel	Ventilator has switched from AC power to Backup Battery operation. Yellow Alarm.
Inops			
X	LOSS OF GAS-SVO	Gas Supplies Lost-SVO	Oxygen and air sources lost, safety valve open.
X	LOW BACKUP BATT	Low Backup Battery	Low Backup Battery voltage.
X	ALARM FAILURE	Audible Alarm Failed	Audible alarm failure.
X	AIR FAULT	Air Source Fault	Internal air source failure.
X	O2 VALVE STUCK	O2 Valve Stuck Closed	Defective oxygen valve.
X	EXH VALVE STUCK	Exp Valve Stuck Open	Defective exhalation valve.

Available on CareNet	CMS message	V200 equivalent	Comments
X	HIGH INT TEMP	High Temperature	Temperature within ventilator enclosure exceeds maximum limit.
X	HIGH INT O2%	High Internal O2	Oxygen concentration within ventilator enclosure exceeds maximum limit.
NOTE: The following alarm messages are not displayed on the CMS:			
	Bad ADCWrap Sensor		ERROR
	Bad Bat Volt Sensor		Service Due
	Bad Int O2 Sensor		Using Default Altitude
	Bad Int Temp Sensor		Using Default Compl
	Battery Charging		Using Default Settings

Analog Output (Chart Recorder)

The Communications-Print option enables the ventilator to send ventilator data to a chart recorder or similar device using the analog output port.

Data displayed via the chart recorder is for reference purposes only. Decisions for patient care should not be based solely on the data displayed via the chart recorder.

Table 13-3 summarizes the Analog Output pinout.

Respironics V200 Ventilator Analog Output Port Pinout	
Pin Number	Signal
1	Flow signal return
2	Volume signal return
3	Pressure signal return
4	Alarm signal return
5	Nebulizer signal return
9	Flow (0 V = -200 LPM, 5 V = 200 LPM)
10	Volume (0 V = 0 ml, 5 V = 2500 ml)
11	Pressure (0 V = -20 cmH ₂ O, 5 V = 120 cmH ₂ O)
12	Alarm (0 V = active alarm, 1.5 V = no alarm or silenced alarm)

Respironics V200 Ventilator Analog Output Port Pinout	
13	Nebulizer (0 V = exhalation phase, 5 V = inhalation or plateau phase)
14	No data
15	No data
NOTE:	All analog outputs = 0 V at power up. Voltages have a linear relationship to the corresponding values. For example, 2.5 V on pin 9 = 0 LPM, 2.5 V on pin 11 = 70 cmH ₂ O.
NOTE:	The resolution of the analog output is 0 to 5 V in 256 increments.

Table 13-3: Ventilator Analog Output Port Pinout

(This page is intentionally blank.)

RS-232 Communications Option 2 (Com2)

The Respirationics V200 Ventilator allows the transmission of data from the ventilator to the RS-232 communications interface. The Com2 option allows the ventilator to communicate with data systems. The ventilator has two communications options, Com1 and Com2, which work exclusively of one another.

WARNING: It is the responsibility of the end user to validate the compatibility and use of information transmitted from the ventilator with the device to be connected to the ventilator.

WARNING: The data provided via the Com2 option is for reference only. Decisions for patient care should be based on the clinician's observations of the patient.

RS-232 Configuration

When the Com2 option is installed, the RS-232 communications port is configured for all communications functions in the following manner:

- Baud Rate 9,600
- Data Bits 8
- Parity None
- Stop Bits 1

NOTE: In diagnostics mode, with Com2 installed, the baud rate is 19,200.

To properly use the Com2 option, connect the communications cable to the 9-pin serial connection on the back of the ventilator.

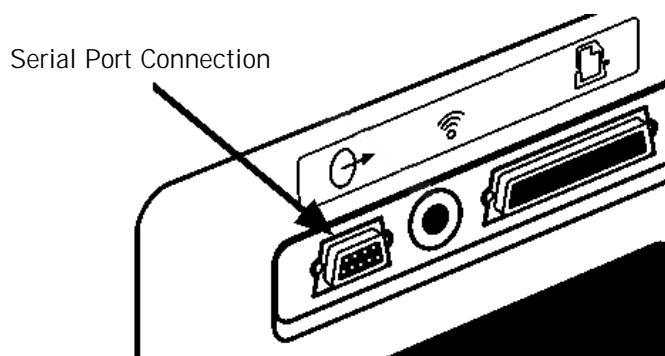

Figure 13-26: 9-pin serial port connection

Options and Accessories

Ventilation Report					
Description	Example	Resolution	Range	Units	Comments
Not used	♦♦♦♦♦	N/A	N/A	N/A	Outputs example value.
Date	FEB♦23♦1997♦	N/A	N/A	N/A	12 character field, MMM♦DD♦YYYY♦
Mode setting	CMV♦♦♦	N/A	CMV♦♦♦ SIMV♦♦ CPAP♦♦	N/A	Assist/Control = CMV, Spont/Timed = SIMV, Spont = CPAP
Active Respiratory Rate setting	12.0♦♦	0.1 or 1	1.0 – 9.0 10 – 80	BPM	Outputs ♦♦♦♦♦ when mode is CPAP or Spont.
VCV Tidal Volume setting	0.50♦♦	0.01	0.05 – 2.50	L	
VCV Peak Flow setting	5♦♦♦♦	1	3 – 140	LPM	
Oxygen Concentration setting	100♦♦♦	1	21 – 100	%	
Pressure Trigger setting	0.5♦♦♦	0.1	0.1 – 20.0	cm H ₂ O	Outputs value from active type (VCV or PCV). When active type is NPPV then outputs the VCV value.
PEEP or EPAP setting	0.0♦♦♦	0.1	0.0 – 35.0	cm H ₂ O	Uses PEEP setting from active ventilation type (VCV or PCV). When active type is NPPV uses EPAP setting.
VCV Insp. Hold Setting	0.0♦♦♦	0.1	0.0 – 2.0	Sec	
Not used	♦♦♦♦♦	N/A	N/A	N/A	Outputs example value.
Not used	♦♦♦♦♦	N/A	N/A	N/A	Outputs example value.
Not used	♦♦♦♦♦	N/A	N/A	N/A	Outputs example value.
Not used	♦♦♦♦♦	N/A	N/A	N/A	Outputs example value.
VCV Apnea Interval setting	10♦♦♦♦	1	10 – 60	sec	
VCV Apnea Tidal Volume setting (same as Tidal Volume setting)	0.50♦♦	0.01	0.05 – 2.50	L	Outputs VCV Tidal Volume setting

Table 13-4: Ventilation Report (Sheet 2 of 10)

Ventilation Report					
Description	Example	Resolution	Range	Units	Comments
VCV Apnea Respiratory Rate setting	12.0♦♦	0.1 or 1	1.0 – 9.0 10 – 80	BPM	
Apnea Peak Flow setting (same as Peak Flow setting)	5♦♦♦♦♦	1	3 – 140	LPM	Outputs VCV Peak Flow setting
VCV Apnea Oxygen Concentration setting (same as Oxygen Concentration setting)	21♦♦♦♦	1	21 – 100	%	Outputs Oxygen Concentration setting
Pressure Support setting	0♦♦♦♦♦	1	0 – 100	cm H ₂ O	Outputs value from active ventilation type (VCV or PCV). When active type is NPPV then IPAP – EPAP is used.
VCV Flow Pattern setting	SQUARE	N/A	SQUARE, RAMP♦♦	N/A	
Not used	♦♦♦♦♦	N/A	N/A	N/A	Outputs example value.
Not used	♦♦♦♦♦	N/A	N/A	N/A	Outputs example value.
100% Oxygen setting	ON♦♦♦♦	N/A	ON♦♦♦♦ OFF♦♦♦♦	N/A	
Not used	♦♦♦♦♦	N/A	N/A	N/A	Outputs example value.
Not used	♦♦♦♦♦	N/A	N/A	N/A	Outputs example value.
Not used	♦♦♦♦♦	N/A	N/A	N/A	Outputs example value.
Measured total respiratory rate	0.0♦♦♦	0.1 or 1	0.0 – 9.9 10 - 150	BPM	For values greater than 150 output set to 150.
Measured tidal volume	1.15♦♦	0.01	0.00 – 9.99	L	Outputs ♦♦♦♦♦♦ for values out of range.
Measured total minute volume	0.00♦♦	0.01 or 1	0.00 – 9.99 10.0 – 99.9	L	For values out of range output set to 99.9.
Measured spontaneous minute volume	0.00♦♦	0.01 or 0.1	0.00 - 9.99 10.0 – 99.9	L	Outputs ♦♦♦♦♦♦ when ventilation mode is A/C. For values out of range output set to 99.9.

Table 13-4: Ventilation Report (Sheet 3 of 10)

Ventilation Report					
Description	Example	Resolution	Range	Units	Comments
Measured peak inhalation pressure	0.0♦♦♦	0.1 or 1	0.0 – 99.9 100 – 130	cm H ₂ O	Outputs ♦♦♦♦♦ when ventilation mode is CPAP or Spont and No Apnea alarm is present.
Measured mean airway pressure	0.9♦♦♦	0.1 or 1	0.0 – 99.9 100 - 130	cm H ₂ O	
Measured end inhalation pressure	7.7♦♦♦	0.1 or 1	0.0 – 99.9 100 – 130	cm H ₂ O	Outputs ♦♦♦♦♦ when Ventilation type is PCV or NPPV, or Ventilation mode is CPAP or Spont, or VCV Insp. Hold setting = 0.
Measured I:E ratio	0.2♦♦♦	0.1	0.1 – 9.9 10 - 99	N/A	Fractional representation of 1:X.X with one (1) decimal place, e.g., 4:1 = 0.3
High Inhalation Pressure Alarm setting	20♦♦♦♦	1	10 – 105	cm H ₂ O	Outputs high inhalation pressure setting for active ventilation type (PCV or VCV) or IPAP + 10 if NPPV is active.
Low Inhalation Pressure Alarm setting	3♦♦♦♦	1	3 – 105	cm H ₂ O	Outputs Low Inhalation Pressure setting for active ventilation type.
Low PEEP or Low EPAP Alarm setting	0♦♦♦♦	1	0 – 35	cm H ₂ O	Outputs Low PEEP from active type (VCV or PCV). When active type is NPPV uses Low EPAP.

Table 13-4: Ventilation Report (Sheet 4 of 10)

Ventilation Report					
Description	Example	Resolution	Range	Units	Comments
Low Exhaled Mandatory Tidal Volume Alarm setting	0.00♦♦	0.01	0.00 – 2.50	L	For VCV and PCV types of ventilation, set to Low Exhaled Mandatory Tidal Volume alarm limit (for A/C and Apnea) and Low Exhaled Spontaneous Tidal Volume Alarm limit (for SIMV and CPAP). When active type of ventilation is NPPV uses Low Exhaled Tidal Volume alarm limit.
Low Exhaled Minute Volume Alarm setting	0.0♦♦♦	0.1	0.0 – 60.0	L	Low Exhaled Minute Volume alarm limit from active type (VCV, PCV, or NPPV).
High Respiratory Rate Alarm setting	0♦♦♦♦♦	1	0 – 150	BPM	High Respiratory Rate from active type (VCV, PCV, or NPPV).
High Inhalation Pressure Alarm status	NORMAL	N/A	NORMAL, RESET♦, ALARM♦	N/A	
Low Inhalation Pressure Alarm status or Disconnect Alarm status	RESET♦	N/A	NORMAL, RESET♦, ALARM♦	N/A	
Low PEEP or Low EPAP Alarm status	ALARM♦	N/A	NORMAL, RESET♦, ALARM♦	N/A	Outputs Low PEEP in VCV and PCV, Low EPAP in NPPV

Table 13-4: Ventilation Report (Sheet 5 of 10)

Options and Accessories

Ventilation Report					
Description	Example	Resolution	Range	Units	Comments
Low Exhaled Mandatory/ Spontaneous Tidal Volume Alarm status	NORMAL	N/A	NORMAL, RESET♦ ALARM♦	N/A	Outputs ALARM when any of the following alarms are active: Low Mandatory Tidal Volume Alarm, or Low Spontaneous Tidal Volume Alarm, or Low Tidal Volume Alarm Outputs RESET when any of the above alarms are reset and none are active. Outputs NORMAL when none of the above alarms are reset or active.
Low Exhaled Minute Volume Alarm status	NORMAL	N/A	NORMAL, RESET♦ ALARM♦	N/A	
High Respiratory Rate Alarm status	NORMAL	N/A	NORMAL, RESET♦ ALARM♦	N/A	
Low Oxygen Supply Pressure Alarm status	NORMAL	N/A	NORMAL, RESET♦ ALARM♦	N/A	
Air Source Inoperative Alarm status	NORMAL	N/A	NORMAL, RESET♦ ALARM♦	N/A	
Low Battery Alarm status	NORMAL	N/A	NORMAL, RESET♦ ALARM♦	N/A	Status of Low Backup Battery Alarm
Apnea Alarm status	NORMAL	N/A	NORMAL, RESET♦ ALARM♦	N/A	
Not used	♦♦♦♦♦	N/A	♦♦♦♦♦	N/A	Outputs example value.
Not used	♦♦♦♦♦	N/A	♦♦♦♦♦	N/A	Outputs example value.
Time	12:45♦	N/A	N/A	N/A	24 hour clock, hh:mm♦ same as field 5
Not used	♦♦♦♦♦	N/A	♦♦♦♦♦	N/A	Outputs example value.

Table 13-4: Ventilation Report (Sheet 6 of 10)

Ventilation Report					
Description	Example	Resolution	Range	Units	Comments
Date	FEB•23•1997•	N/A	N/A	N/A	12 character field, MMM•DD•YYYY•
Static Compliance	0•••••	1	0 - 350	ml/ cm H ₂ O	Outputs •••••• when Mechanics option is not installed or no maneuver was performed.
Static Resistance	0.0•••	0.1 or 1	0.1 – 99.9 100 – 400	cm H ₂ O/ L/s	Outputs •••••• when Mechanics option is not installed or no maneuver was performed.
Dynamic Compliance	0•••••	1	0 – 350	ml/ cm H ₂ O	Outputs •••••• when Mechanics option is not installed.
Dynamic Resistance	0.0•••	0.1 or 1	0.1 – 99.9 100 – 400	cm H ₂ O/ L/s	Outputs ••••~• when Mechanics option is not installed.
Maximum Inhalation Pressure	0•••••	1	0 – 100	cm H ₂ O	Outputs ••••~• when Mechanics option is not installed or no maneuver was performed.
Vital Capacity	0.0•••	0.1	0.1 – 9.9	L	Outputs ••••~• when Mechanics option is not installed or no maneuver was performed. when the value is out of range output is••••~•.
Peak Lung Flow	0•••••	1	0 - 200	LPM	Outputs ••••~• when Mechanics option is not installed.
Bias Flow	20••••	1	0 – 23	LPM	Outputs 0 when pressure trigger is active, otherwise outputs Flow trigger plus three (3).

Table 13-4: Ventilation Report (Sheet 7 of 10)

Options and Accessories

Ventilation Report					
Description	Example	Resolution	Range	Units	Comments
Flow trigger setting	2♦♦♦♦♦	1	1 – 20	LPM	Outputs Flow trigger setting of active ventilation type.
Not used	♦♦♦♦♦	N/A	N/A	N/A	Outputs example value.
Not used	♦♦♦♦♦	N/A	N/A	N/A	Outputs example value.
Not used	♦♦♦♦♦	N/A	N/A	N/A	Outputs example value.
Not used	♦♦♦♦♦	N/A	N/A	N/A	Outputs example value.
Not used	♦♦♦♦♦	N/A	N/A	N/A	Outputs example value.
Not used	♦♦♦♦♦	N/A	N/A	N/A	Outputs example value.
Not used	♦♦♦♦♦	N/A	N/A	N/A	Outputs example value.
Not used	♦♦♦♦♦	N/A	N/A	N/A	Outputs example value.
Not used	♦♦♦♦♦	N/A	N/A	N/A	Outputs example value.
Not used	♦♦♦♦♦	N/A	N/A	N/A	Outputs example value.
Not used	♦♦♦♦♦	N/A	N/A	N/A	Outputs example value.
Not used	♦♦♦♦♦	N/A	N/A	N/A	Outputs example value.
Not used	♦♦♦♦♦	N/A	N/A	N/A	Outputs example value.
Not used	♦♦♦♦♦	N/A	N/A	N/A	Outputs example value.
Measured end inhalation pressure	20.0♦♦♦	0.1 or 1	0.0 – 99.9 100 – 130	cm H ₂ O	Outputs ♦♦♦♦♦ when Ventilation type is PCV or NPPV, or Ventilation mode is CPAP or Spont, or VCV Insp. Hold setting = 0.
PCV Pressure Setting	100♦♦♦	1	5 – 100	cm H ₂ O	Output 0 when VCV is active, PCV Pressure when PCV is active, ♦♦♦♦♦ when NPPV is active

Table 13-4: Ventilation Report (Sheet 8 of 10)

Ventilation Report					
Description	Example	Resolution	Range	Units	Comments
PCV Inhalation Time Setting	0.10♦♦	0.01	0.10 – 9.90	sec	Outputs PCV Inhalation Time when PCV or VCV is active, NPPV Inhalation Time when NPPV is active
PCV or NPPV Apnea Interval Setting	10♦♦♦♦	1	10 – 60	sec	Outputs PCV Apnea Interval when PCV or VCV is active, NPPV Apnea Interval when NPPV is active
PCV Apnea Inhalation Pressure Setting or NPPV Apnea IPAP setting	100♦♦♦	1	5 – 100	cm H ₂ O	Outputs PCV Pressure setting when VCV or PCV active, IPAP – EPAP when NPPV active
PCV Apnea Respiratory Rate Setting or NPPV Apnea Respiratory Rate Setting	12♦♦♦♦	0.1 or 1	1.0 - 9.9 10 – 80	BPM	Outputs PCV Apnea Rate setting when VCV or PCV active, NPPV Apnea rate when NPPV active
PCV Apnea Inhalation Time Setting or NPPV Apnea Inhalation Time Setting	2.00♦♦	0.01	0.10 – 9.90	sec	Outputs PCV Inhalation Time setting when VCV or PCV active, NPPV Inhalation Time when NPPV active
PCV Apnea Oxygen Concentration Setting or NPPV Apnea Oxygen Concentration	100♦♦♦	1	21 – 100	%	
PCV Apnea High Inhalation Pressure Setting or NPPV Apnea High Inhalation Pressure Setting	20♦♦♦♦	1	10 – 105	cm H ₂ O	Outputs PCV High Inhalation Pressure setting when VCV or PCV active, IPAP + 10 when NPPV active
Alarm Silence Status	ON♦♦♦♦	N/A	ON ♦♦♦♦ OFF♦♦♦♦	N/A	
Apnea Alarm Status	NORMAL	N/A	NORMAL, RESET♦ ALARM♦	N/A	

Table 13-4: Ventilation Report (Sheet 9 of 10)

Ventilation Report					
Description	Example	Resolution	Range	Units	Comments
Occlusion Alarm Status or SM Occlusion Alarm Status or I-Time Too Long Alarm Status	NORMAL	N/A	NORMAL, RESET♦ ALARM♦	N/A	
Not used	♦♦♦♦♦	N/A	♦♦♦♦♦	N/A	Outputs example value.
Not used	♦♦♦♦♦	N/A	♦♦♦♦♦	N/A	Outputs example value.
Not used	♦♦♦♦♦	N/A	♦♦♦♦♦	N/A	Outputs example value.
Not used	♦♦♦♦♦	N/A	♦♦♦♦♦	N/A	Outputs example value.
Not used	I-TIME	N/A	I-TIME	N/A	Outputs example value.
I:E Ratio	1:99	N/A	9.9:1 - 1:99	N/A	measured I:E ratio, expressed as 1:X.X, 1:XX, X.X:1, or XX:1.
Stop Code	0x03	N/A	N/A	N/A	ASCII End Transmission Character (ETX)

Table 13-4: Ventilation Report (Sheet 10 of 10)

(This page is intentionally blank.)

Respiratory Mechanics Option

The Respiratory Mechanics option allows the Respironics V200 Ventilator to perform respiratory mechanics maneuvers, including:

- Vital Capacity (VC): The VC maneuver measures the patient's lung capacity. It is available only in Volume Control Ventilation (VCV) and Pressure Control ventilation (PCV).
- Maximum Inspiratory Pressure (MIP): The MIP maneuver measures the maximum negative pressure resulting from the patient's inspiratory effort. It is available only in VCV and PCV. MIP is also known as *negative inspiratory force (NIF)*.
- Occlusion Pressure at 100 ms (PO.1): The PO.1 maneuver measures the pressure change after the first 100 milliseconds (ms) of an inspiratory phase. It is available only in VCV and PCV. This maneuver is also known as *P100*.
- Static Compliance and Resistance (Static C and R): The static C and R maneuver estimates the compliance and resistance of the patient's lungs. It is available only in VCV.
- Plateau Pressure (P_{plat}) is a measured value collected during the last saved Static C and R maneuver.
- The results of maneuvers are displayed graphically and numerically. The Respiratory Mechanics option also displays dynamic compliance and resistance, inspiratory time divided by total breath time (T_I/T_{TOT}), and peak lung flow (Peak L-Flow).

Accessing Respiratory Mechanics Data

Touch the Mechanics icon button at the bottom of the screen (Figure 13-27).

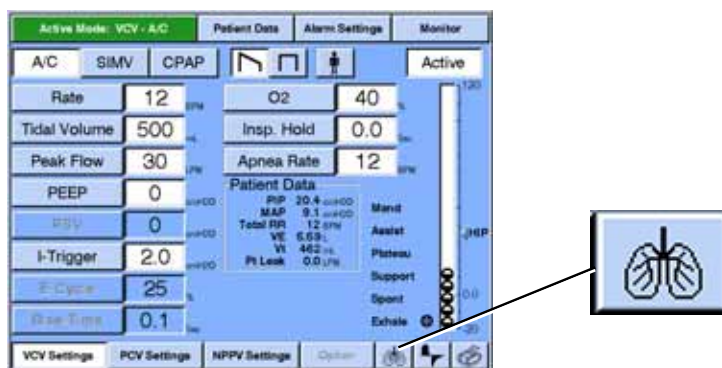

Figure 13-27: VCV Settings Screen and Mechanics Icon Button

When you touch the Mechanics icon button, the *Patient Status* screen appears, see Figure 13-28. This screen displays patient data and includes derived lung mechanics results, weaning parameters, ventilator settings, maneuver date and time stamps, and other patient data. It also provides access to the respiratory mechanics maneuvers via the maneuver buttons on the bottom of the screen.

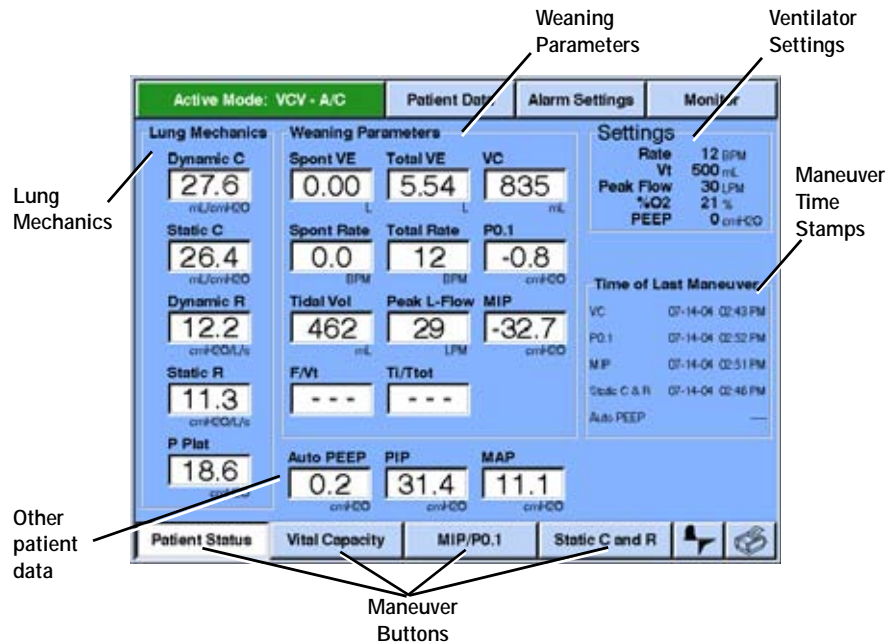

Figure 13-28: Patient Status Screen

Vital Capacity Maneuver

The *Vital Capacity* screen (Figure 13-29) allows you to perform a Vital Capacity maneuver and displays the maneuver results graphically and numerically. The Vital Capacity maneuver is available only in VCV and PCV. It is not available in NPPV.

How to perform the Vital Capacity Maneuver

1. Enter the *Vital Capacity* screen: Touch the Mechanics icon button, then the *Vital Capacity* button.
2. Touch the *Start* button. Instruct the patient to inhale to maximum capacity at the next inspiration, then exhale completely, followed by a normal inspiration.

Once touched, the *Start* button changes to *Stop*. The *Stop* button allows you to cancel the maneuver at any time. A high-priority alarm automatically cancels the maneuver.

3. At the end of a successful maneuver, a pop-up screen displays the result of the maneuver and asks you to accept or reject the results by touching the *Accept* or *Reject* button.
4. At the end of the maneuver (whether successful or cancelled), the *Stop* button changes to *Continue*. While the *Continue* button is displayed, the graph is frozen and can be rescaled. Touch *Continue* or exit the screen to unfreeze the display.
5. Touch *Continue*: the button changes to *Start* and you can repeat the maneuver.

WARNING: Perform the Vital Capacity maneuver according to instructions. Because machine-assisted breath delivery, apnea detection, and detection of certain patient alarms are temporarily disabled during a Vital Capacity maneuver, close clinical supervision is recommended.

WARNING: Because PEEP is temporarily set to 0 cmH₂O during a Vital Capacity maneuver, close clinical supervision is recommended.

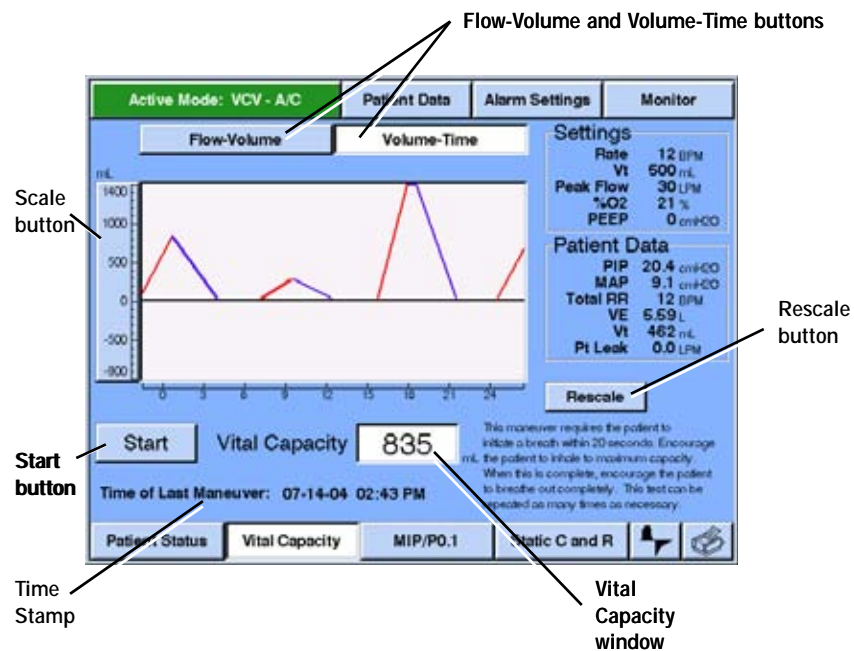

Figure 13-29: Vital Capacity Screen

Information type	Description
<i>Flow-Volume</i> or <i>Volume-Time</i> button	<i>Flow-Volume</i> : Displays a real-time flow-volume loop. <i>Volume-Time</i> : Displays a real-time volume-time waveform.
<i>Start</i> button	Starts the maneuver. Changes to <i>Stop</i> when the maneuver is started. Changes to <i>Continue</i> when the maneuver is complete or when the <i>Stop</i> button is touched. Changes to <i>Start</i> when <i>Continue</i> is touched.
<i>Vital Capacity</i> window	Displays the most recently accepted VC maneuver results. The date and time of the maneuver appear below the window.
<i>Scale</i> (button at left of graphic display)	Allows you to adjust graphic scales manually. The default scales for the <i>Vital Capacity</i> screen are -1000 to +1500 mL for volume, -100 to +100 LPM for flow. Default scales are in effect every time you enter the <i>Vital Capacity</i> screen.
<i>Rescale</i> button	Allows software to adjust the vertical scales for waveforms and vertical and horizontal scales for loops.

Table 13-5: Summary of Vital Capacity Screen Information

MIP/PO.1 Maneuver

The *MIP/PO.1* screen (Figure 13.J4) allows you to perform a Maximum Inspiratory Pressure (MIP) or occlusion pressure at 100 ms (PO.1) maneuver. It displays the maneuver results graphically and numerically. The MIP maneuver is available only in VCV and PCV. It is not available in NPPV.

How to perform an MIP or PO.1 maneuver

1. Enter the *MIP/PO.1* screen: touch the Mechanics icon button, then *MIP/PO.1*.
2. MIP maneuver: hold down the *Start MIP Press & Hold* button, and instruct the patient to inhale several times as forcefully as possible. The maneuver automatically ends after 30 seconds or when you release the *Start MIP Press & Hold* button. (The *Start MIP Press & Hold* button can be pressed and held at any time during a breath. If pressed during the inhalation phase of a breath, the MIP maneuver will be executed during the exhalation phase of that breath. If pressed during an exhalation, the maneuver will be executed during the same exhalation.)

PO.1 maneuver: touch the *Start PO.1* button. A message above the graphic display shows the results for the just-completed breath. The maneuver automatically ends after four preselected patient-initiated breaths have occurred or one minute has elapsed, whichever comes first.

3. Once touched, either one of the *Start* buttons changes to *Stop*. The *Stop* button allows you to cancel the maneuver at any time. A high-priority alarm also cancels the maneuver.
4. At the end of a successful maneuver, a pop-up screen displays the result of the maneuver and asks you to accept or reject the results by touching the *Accept* or *Reject* button.

5. At the end of the maneuver (whether successful or cancelled), the *Stop* button changes to *Continue*. While the *Continue* button is displayed, the graph is frozen and can be rescaled. Touch *Continue* or exit the screen to unfreeze the display.
6. Touch *Continue*: the button changes to *Start* and you can repeat the maneuver.

WARNING: Perform the MIP maneuver according to instructions. Because machine assisted breath delivery, apnea detection, and detection of certain patient alarms are temporarily disabled during a MIP maneuver, close clinical supervision is recommended.

WARNING: Because PEEP is temporarily set to 0 cmH₂O during a MIP maneuver, close clinical supervision is recommended.

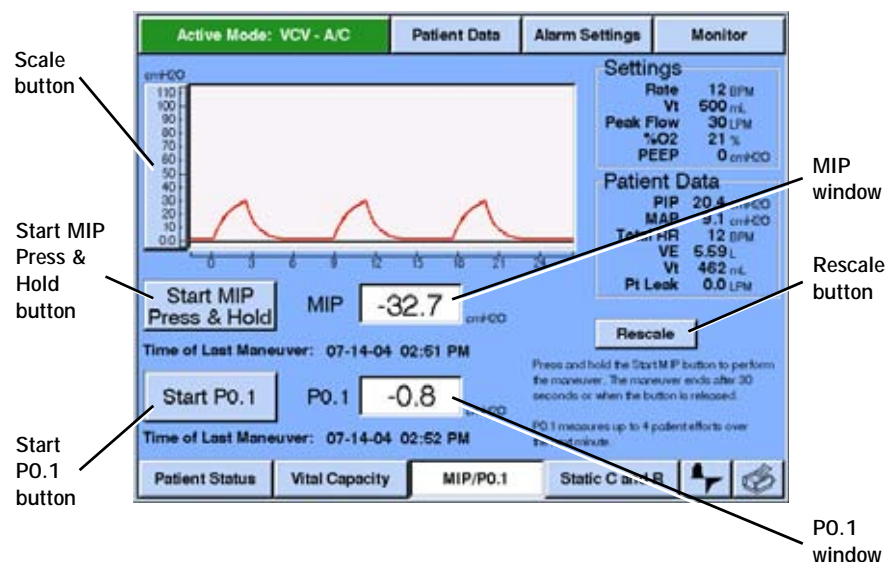

Figure 13-30: MIP/PO.1 Screen

Information type	Description
<i>Start MIP Press & Hold</i> button	Starts the MIP maneuver. Changes to <i>Continue</i> when the maneuver is complete or when finger is lifted from the button. Changes to <i>Start</i> when <i>Continue</i> is touched.
<i>Start PO.1</i> button	Starts the PO.1 maneuver. Changes to <i>Stop</i> when the maneuver is started. Changes to <i>Continue</i> when the maneuver is complete or when the <i>Stop</i> button is touched. Changes to <i>Start</i> when <i>Continue</i> is touched.
<i>MIP</i> window	Displays the most recently accepted maneuver results. The date and time of the maneuver appears below each window.
<i>PO.1</i> window	Displays the most recently accepted maneuver results. The date and time of the maneuver appears below each window.
<i>Scale</i> (button at left of graphic display)	Allows you to adjust graphic scales manually. The default scale for the MIP/PO.1 screen is -100 cmH ₂ O to the High Pressure limit. Default scales are in effect every time you enter the <i>MIP/PO.1</i> screen, and the graph reverts to default scales when the maneuver is complete.
<i>Rescale</i> button	Allows software to adjust the vertical scales for waveforms and vertical and horizontal scales for loops. The graph cannot be rescaled during the MIP maneuver.

Table 13-6: Summary of MIP/PO.1 Screen Information

Static C and R Maneuver

The *Static C and R* screen (Figure 13-31) allows you to perform a static compliance and resistance maneuver and displays the maneuver results. The maneuvers are carried out on machine or operator initiated breaths. If the patient triggers a breath when a maneuver is scheduled, the ventilator does not perform the maneuver. Although the maneuver does not require patient effort, patient interference can affect the accuracy of maneuver results. The *Static C and R* maneuver is available in VCV only. It is *not* available in PCV and NPPV.

NOTE: Depending on the *High Pressure* limit setting, if the pre-maneuver flow pattern is ramp, delivering a square waveform during the *Static C and R* maneuver can trigger a *High Inspiratory Pressure* alarm and cancel the maneuver. Should this happen, adjust alarm settings as needed.

How to perform Static C and R maneuver

1. Enter the *Static C and R* screen: touch the Mechanics icon button, then *Static C and R*.
2. Touch the *Start* button. If you do nothing, the maneuver automatically ends at the next mandatory inspiration.

Once touched, the *Start* button changes to *Stop*. The *Stop* button allows you to cancel the maneuver at any time. A high-priority alarm automatically cancels the maneuver.

- At the end of a successful maneuver, a pop-up screen displays the result of the maneuver and asks you to accept or reject the results by touching the *Accept* or *Reject* button.
- At the end of the maneuver (whether successful or cancelled), the *Stop* button changes to *Continue*. While the *Continue* button is displayed, the graph is frozen and can be rescaled. Touch *Continue* or exit the screen to unfreeze the display.
- Touch *Continue*: the button changes to *Start* and you can repeat the maneuver.
- Return the active ventilation mode from VCV to the previous mode if necessary.

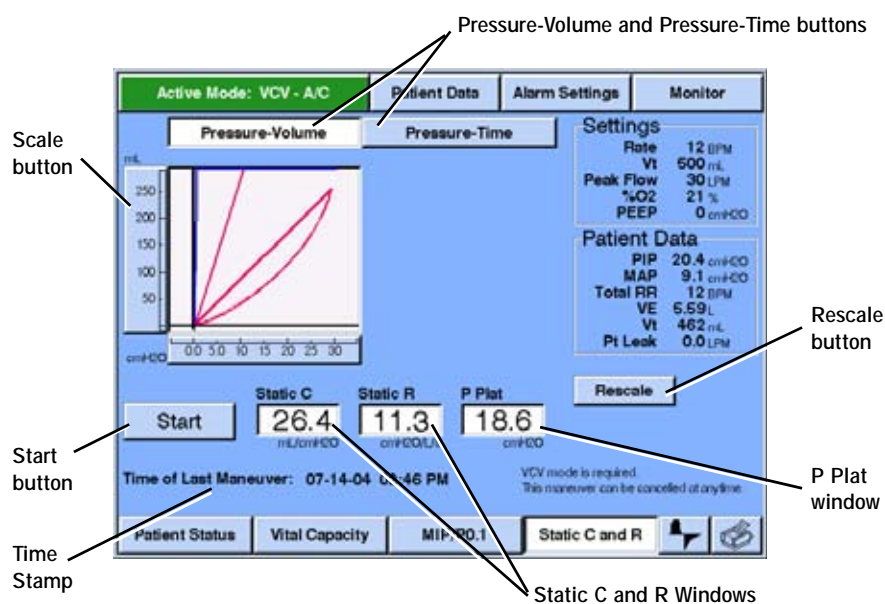

Figure 13-31: Static C and R Screen

Information type	Description
<i>Pressure--Volume</i> or <i>Pressure--Time</i> button	<i>Pressure--Volume</i> : Displays a real-time pressure-volume loop. <i>Pressure--Time</i> : Displays a real-time pressure-time waveform.
<i>Start</i> button	Starts the maneuver. Changes to <i>Stop</i> when the maneuver is started. Changes to <i>Continue</i> when the maneuver is complete or when the <i>Stop</i> button is touched. Changes to <i>Start</i> when <i>Continue</i> is touched.
<i>Static C</i> and <i>Static R</i> windows	Displays the most recently accepted maneuver results. The date and time of the maneuver appear below each window.

Table 13-7: Summary of Static C and R Screen Information

Information type	Description
P_{plat} window	Displays the most recently accepted maneuver results. The date and time of the maneuver appear below each window.
Scale (button at left of graphic display)	Allows you to adjust graphic scales manually. The default scales for the <i>Static C & R</i> screen are 0 cmH ₂ O to the High Pressure limit for pressure, 0 to Vt + 100 mL for volume. Default scales are in effect every time you enter the <i>Static C and R</i> screen.
Rescale button	Allows software to adjust the vertical scales for waveforms and vertical and horizontal scales for loops.

Table 13-7: Summary of Static C and R Screen Information

Alarms and Error Messages

If an alarm occurs during Respiratory Mechanics, an Alerts window lists the active alarms. Any active maneuvers are cancelled if a high-priority alarm occurs. If there is a preexisting alarm of any priority when you attempt to start a maneuver, the maneuver cannot be performed and an error message is displayed. Table 13-8: "Respiratory Mechanics Error Messages and Alarms" summarizes error messages and changes that can occur during Respiratory Mechanics.

Maneuver	Error Messages	Temporarily Disabled Alarms
VC	<p>Measurement out of range Measured volume exceeds 9999 mL.</p> <p>Vital Capacity unavailable due to alarm condition Alarm condition exists when maneuver requested.</p> <p>Maneuver cancelled Operator presses Stop button.</p> <p>Maneuver timed out No inspiration within 20 seconds of starting maneuver.</p> <p>Maneuver cancelled by alarm condition Alarm condition occurs after maneuver begins.</p>	<ul style="list-style-type: none"> •Low Exhaled Minute Volume •Low Exhaled Mandatory Tidal Volume •High Exhaled Minute Volume •Low Exhaled Spontaneous Tidal Volume •Low PEEP
MIP	<p>Measurement out of range Measured pressures exceed -100 to +200 cmH₂O.</p> <p>MIP unavailable due to alarm condition Alarm condition exists when maneuver requested.</p> <p>Maneuver timed out MIP button held down for 30 seconds since starting maneuver.</p>	<p>All patient alarms and the Low O₂ alarm are disabled during the MIP maneuver.</p>

Table 13-8: Respiratory Mechanics Error Messages and Alarms

Maneuver	Error Messages	Temporarily Disabled Alarms
P0.1	<p data-bbox="683 386 1078 464">Measurement out of range Measured pressures exceed -100 to +200 cmH₂O.</p> <p data-bbox="683 495 1078 573">P0.1 unavailable due to alarm condition Alarm condition exists when maneuver requested.</p> <p data-bbox="683 604 1078 682">Maneuver cancelled Operator presses Stop button and no P0.1 maneuver breaths performed.</p> <p data-bbox="683 714 1078 791">Maneuver cancelled by alarm condition Alarm condition occurs after maneuver begins.</p> <p data-bbox="683 823 1078 900">Maneuver timed out One minute elapses with no P0.1 maneuver breaths performed.</p>	None: all alarms are active during the P0.1 maneuver.

Table 13-8: Respiratory Mechanics Error Messages and Alarms

Maneuver	Error Messages	Temporarily Disabled Alarms
Static C and R	<p>Measurement out of range. Check tubing system for leaks Static compliance exceeds 0 to 350 mL/cmH₂O or static resistance exceeds 0 to 400 cmH₂O/L/s:</p> <p>Static C & R unavailable due to alarm condition Alarm condition exists when maneuver requested.</p> <p>Static C & R only available in VCV Ventilator not in VCV mode.</p> <p>Static C & R unavailable; I-Time less than 200ms Inspiration time must be between 200 ms and 5 seconds.</p> <p>Static C & R unavailable; I-Time greater than 5 seconds Inspiration time must be between 200 ms and 5 seconds.</p> <p>Plateau pressure stability not achieved; Static C & R unavailable Stable plateau pressure cannot be achieved.</p> <p>Maneuver cancelled Operator presses Stop button.</p> <p>Maneuver timed out No machine or operator initiated inspiration within 20 seconds of starting maneuver.</p> <p>Maneuver cancelled by alarm condition Alarm condition occurs after maneuver begins.</p>	None: all alarms are active during the Static C and R maneuver.

Table 13-8: Respiratory Mechanics Error Messages and Alarms

Parameter	Description
Vital Capacity (VC) maneuver	<p>Procedure: The clinician instructs the patient to inhale to maximum capacity at the next inspiration, then exhale completely, followed by a normal inspiration. The maneuver automatically ends at the next inspiration (following the maneuver breath) or if 20 seconds elapse without another inspiration. Available in VCV and PCV. Not available in NPPV.</p> <p>During the maneuver: Once the maneuver starts, settings for maneuver breath are mode = CPAP, PEEP = 0 cmH₂O (during the start of the next inhalation or exhalation following pressing the start button), and PSV = 0 cmH₂O. For the breath following the maneuver breath, PSV = 0 cmH₂O and PEEP is restored to its original setting. Pre-maneuver settings are restored during exhalation of the breath following the maneuver breath. Any scheduled breaths that were postponed by the VC maneuver are delivered after the maneuver is complete.</p> <p>Results display: Measured volumes from 0 to 9999 mL are displayed for the VC maneuver: if measured volume exceeds these limits, only a message (no data) is displayed. VC is displayed in mL, and is time-stamped based on ventilator time and date.</p> <p>Range: 0 to 9999 mL</p> <p>Resolution: 1 mL</p> <p>Accuracy: ± 10% of true value</p>
Maximum Inspiratory Pressure (MIP) maneuver	<p>Procedure: To perform a MIP maneuver, the clinician asks the patient to inhale as forcefully as possible against a closed circuit that allows the patient to exhale through a one-way valve. Available in VCV and PCV. Not available in NPPV.</p> <p>During the maneuver: Once the maneuver starts, settings for maneuver breath are mode = CPAP, PEEP = 0 cmH₂O (during the start of the next inhalation or exhalation following pressing the start button), and PSV = 0 cmH₂O. For the breath following the maneuver breath, PSV = 0 cmH₂O and PEEP is restored to its original setting. Any gas exhaled during an MIP maneuver is not applied to the tidal volume or minute volume calculations.</p> <p>Results display: MIP is displayed in cmH₂O, and is time-stamped based on ventilator time and date. Measured pressures from -100 to +200 cmH₂O are displayed for the MIP maneuver: If measured pressure exceeds these limits, only a message (no data) is displayed.</p> <p>Range: -100 to +200 cmH₂O</p> <p>Resolution: 1 cmH₂O</p> <p>Accuracy: ± 10% of true value</p>

Table 13-9: Respiratory Mechanics Maneuver Summary and Data Specifications

Parameter	Description
Occlusion pressure at 100 ms (PO.1) maneuver	<p>Procedure: No instructions to the patient are required. Available in VCV and PCV. Not available in NPPV.</p> <p>During the maneuver: Settings do not change during the PO.1 maneuver. The ventilator briefly occludes the patient circuit and measures occlusion pressure in the first 100 ms of four preselected patient initiated breaths. If you press Stop during a PO.1 maneuver, results are displayed for the maneuver breaths that did occur.</p> <p>Results display: PO.1 is displayed in cmH₂O, and is time-stamped based on ventilator time and date. Measured pressures from -100 to +200 cmH₂O are displayed for the PO.1 maneuver. If measured pressure exceeds these limits, only a message (no data) is displayed.</p> <p>Range: -100 to +200 cmH₂O</p> <p>Resolution: 1 cmH₂O</p> <p>Accuracy: ± (0.5 cmH₂O) ± (10%) of true value</p>

Table 13-9: Respiratory Mechanics Maneuver Summary and Data Specifications

Parameter	Description
Static compliance and resistance (static C and R) maneuver	<p>Procedure: Patient participation is not required, and patient interference can affect the accuracy of the maneuver. If the patient initiates a breath when a maneuver breath is scheduled, the ventilator does not perform the maneuver. Available in VCV only. Not available in PCV and NPPV.</p> <p>During the maneuver: The ventilator delivers a square waveform, regardless of the current setting. No other settings change during the static C and R maneuver. The maneuver is not performed unless a machine or operator triggered breath is delivered within 20 seconds. The inspiration time must be between 200 ms and 5 seconds for the maneuver to occur, and the maximum plateau duration is 2.5 seconds.</p> <p>Results display: Static compliance is displayed in mL/cmH₂O. Static resistance is displayed in cmH₂O/L/s. All compliance and resistance values are measured on time or operator triggered mandatory breaths only. During the last saved Static C and R maneuver, Plateau Pressure (P_{plat}) is measured and displayed as a static value. Static C and R are time-stamped based on ventilator time and date. Static compliance values from 0 to 350 mL/cmH₂O and static resistance values from 0 to 400 cmH₂O/L/s are displayed. If either value exceeds its limits or a stable plateau pressure cannot be achieved, only a message (no data) is displayed.</p> <p>Range: Static compliance: 0 to 350 mL/cmH₂O Static resistance: 0 to 400 cmH₂O/L/s Plateau Pressure: -20 to 130 cmH₂O</p> <p>Resolution: Static compliance: 1 mL/cmH₂O Static resistance: 1 cmH₂O/L/s Plateau Pressure: 1 cmH₂O</p> <p>Accuracy: Static compliance: ± 1 mL/cmH₂O ± 20% of true value Static resistance: ± 3 cmH₂O/L/s ± 20% of true value Plateau Pressure: ± (0.5 cmH₂O) ± (10%) of true value</p>
Inspiratory time divided by total breath time (TI/TTOT).	<p>Calculated inspiratory time divided by total breath time, or percent inspiratory time. An eight-breath running average. Available in VCV, PCV, and NPPV.</p> <p>Applicable to spontaneous and pressure-supported breaths only. If there were no spontaneous or pressure-supported breaths within the last one minute, - - - is displayed.</p>

Table 13-9: Respiratory Mechanics Maneuver Summary and Data Specifications

Parameter	Description
Peak lung flow (Peak L-Flow)	The maximum measured inspiratory flow at the patient wye. Available in VCV and PCV. Peak L-Flow is displayed in LPM.
Dynamic compliance and resistance	An estimation of the compliance and resistance of the patient's lungs, using the Least Square Estimation algorithm on the equation of motion ($P = R \cdot Q + V/C$, where Q = lung flow and V = lung volume), performed during each machine or operator initiated inspiration. Dynamic compliance is displayed in mL/cmH ₂ O. Dynamic resistance is displayed in cmH ₂ O/L/s. All compliance and resistance values are estimated on time or operator triggered mandatory breaths only. If there were no machine or operator initiated breaths within the last one minute, - - - is displayed. These alarms interrupt dynamic compliance and resistance updates: Corrupt Compliance, Corrupt Altitude, High Pressure, Low Insp pressure, Air Source Fault, O2 Valve stuck closed, Exh Valve stuck open, Low Tidal volume, Low PEEP. Dynamic compliance values from 0 to 350 mL/cmH ₂ O and dynamic resistance values from 0 to 400 cmH ₂ O/L/s are displayed: (If either value is above its limit, only + + + is displayed. If either value is below its limit, only - - - is displayed.)

Table 13-9: Respiratory Mechanics Maneuver Summary and Data Specifications

Compliance (C) and Resistance (R) Computations

Dynamic C and R are estimated during ventilator and operator initiated breaths. Static C and R are estimated during a *Static C and R* maneuver.

Dynamic Compliance

Dynamic compliance is calculated using these equations:

$$C_L = \frac{\left[\sum_{i=0}^n Q_i V_i \right]^2 - \sum_{i=0}^n Q_i^2 \sum_{i=0}^n V_i^2}{\sum_{i=0}^n Q_i V_i^* \sum_{i=0}^n P_i Q_i - \sum_{i=0}^n P_i V_i^* \sum_{i=0}^n V_i}$$

Dynamic Resistance

Dynamic resistance is calculated using this equation.

$$R_L = \frac{\sum_{i=0}^n Q_i V_i^* \sum_{i=0}^n P_i V_i - \sum_{i=0}^n P_i Q_i^* \sum_{i=0}^n V_i}{\left[\sum_{i=0}^n Q_i V_i \right]^2 - \sum_{i=0}^n Q_i^2 \sum_{i=0}^n V_i^2}$$

Where:

n = Number of samples taken during for the calculation

i = Sample number

Q_i = Patient flow

V_i = Lung volume for the i^{th} sample number = $\int Q_i^* dt$

P_i = Pressure sensor measurement for the i^{th} sample number

Static C and R

Static C and R are calculated using these equations:

$$C_L = \frac{V}{(P_{eplat} - P_0)}$$

$$CR_L = \frac{(P_{ei} - (P_{eplat} - PV_{plat}/C_L))}{Q_{Lend}}$$

Where:

- C_L = The value of the combined compliance of the lungs and chest wall
- R_L = The value of the combined resistance elements between the patient wye and the alveoli of the lungs
- V = Lung volume
- P_{eplat} = End of plateau pressure
- V_{plat} = Lung volume added during the plateau phase
- Q_{Lend} = Patient flow at the end of the delivery phase (beginning of plateau phase)
- P_O = Pressure at the start of inspiration
- P_{ei} = Pressure at the end of inspiration

(This page is intentionally blank.)

Trending Option

The Trending option allows the ventilator to store and display ventilator information for intervals from 2 to 72 hours. Trended data includes:

- Patient data.
- Ventilator settings.
- Lung mechanics data (most of the data in this category is available only if the Respiratory Mechanics option is installed).
- Respiratory profile monitor data (data in this category is available only if the respiratory profile monitor interface (NICO-Esprit) option is installed).

All data is date and time-stamped, and 32 parameters are stored for use by the Trending option.

You can view three trended parameters at a time, and you can change the displayed parameters and time scale at any time.

Accessing Trending Data

Touch either the *Patient Data* button at the top of any settings screen (VCV, PCV, or NPPV) or the Graphics icon button at the bottom of the screen (Figure 13-32). If the Graphics option is not installed, the Graphics button is grayed and Trending is only accessible from the *Patient Data* screen.

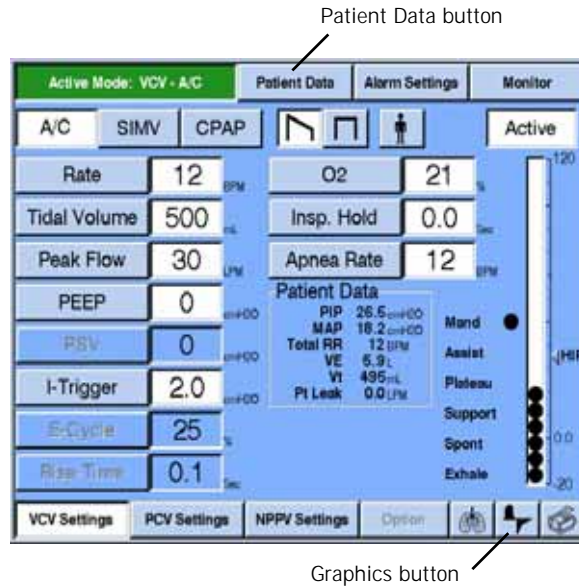

Figure 13-32: VCV Settings Screen

In the *Patient Data* screen (Figure 13-33) or *Graphics* screen (not shown), touch the *Trending* button to display the *Trending* screen (Figure 13-34).

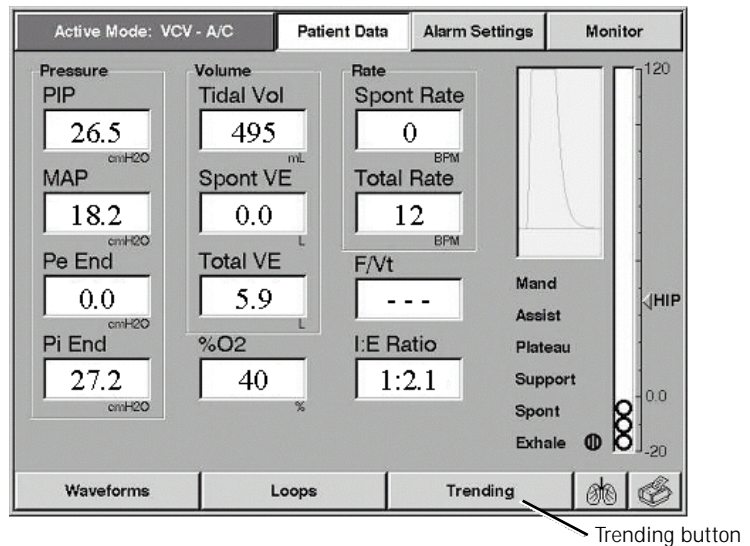

Figure 13-33: Patient Data Screen

The *Trending* screen (Figure 13-34) displays three trending waveforms as well as a summary of ventilator settings and patient data. You can change the waveforms and time scale at any time.

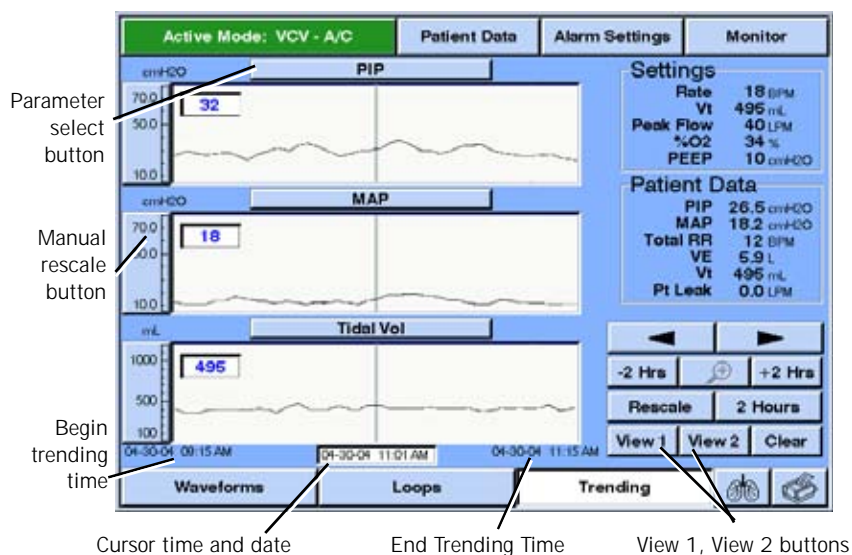

Figure 13-34: Trending Screen

Summary of Trending Screen Information





Information type	Description
Parameter select buttons	Selects which parameter to display in the trending waveform.
Manual rescale buttons	Selects the upper and lower limits for the displayed parameter.
Cursor arrow buttons	Changes the position of the cursor. (You can also use the front panel control knob to adjust cursor position.)
	
-2 Hrs and +2 Hrs buttons	Shifts the waveform forward or backward by 2 hours without changing the time scale. If you press and hold the buttons, the time scale shifts every ½ second. If less than 2 hours of data exists, the waveform shifts by the time available. The button is grayed if the waveform cannot shift any further.
	
Zoom in/out button	Zoom in sets the time scale to 2 hours, with time centered at the cursor position. The button is grayed if the current time scale is 2 hours.
	
	Zoom out button returns the time scale to its previous setting.
Rescale button	Automatically adjusts the vertical axis for all three waveforms for optimal viewing based on the maximum and minimum values for the currently displayed data.
	

Table 13-10: Summary of Trending Screen Information



Time scale button	Displays the time scale menu to select from 2 to 72 hours. The button shows the currently selected time scale.
	
View 1 and View 2 buttons	Displays either of two user-defined views. Each view consists of three trending waveforms and a time scale. The button shows the active view.
	
Clear button	Clears all stored trended data.
	

Table 13-10: Summary of Trending Screen Information

Selecting Parameters for Display

On the *Trending* screen (Figure 13-35), a Parameter select button above each waveform shows the name of the currently displayed parameter. To choose a different parameter for display, press the button above the waveform: a *Trended Data* pop-up window allows you to select another parameter.

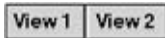
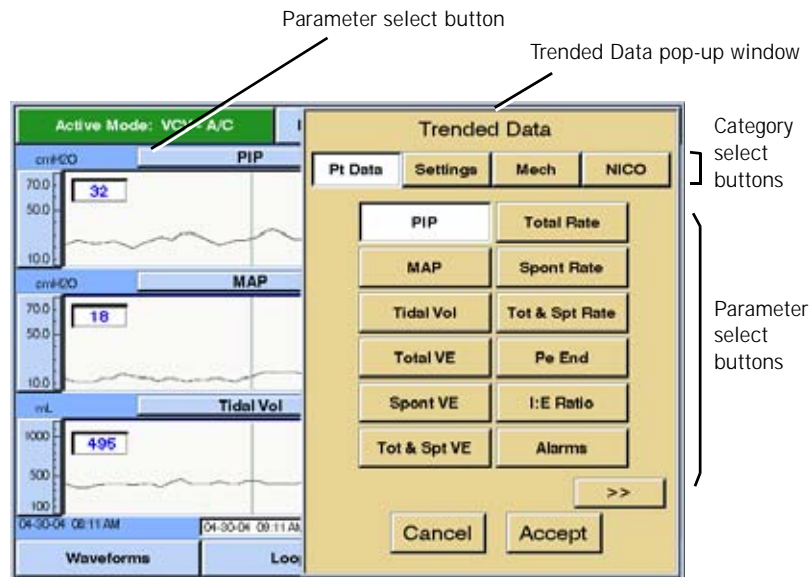

Figure 13-35: Selecting Parameters for Display on the Trending Screen

Four category select buttons (*PT Data*, *Settings*, *Mech*, *NICO*) appear at the top of the *Trended Data* pop-up window. Each button, when pressed, displays a different set of Parameter select buttons. There are a total of 78 parameters that are displayed by the four category select buttons. Below is a summary of each category select button.

- The *Pt Data* category includes measured and calculated patient data parameters.
- The *Settings* category includes ventilator settings.
- The *Mech* category includes lung mechanics data (most of the *Mech* parameters are available only if the Respiratory Mechanics option is installed).
- The NICO category includes data collected from the Respiratory Profile Monitor. This category is available only if the respiratory profile monitor interface (NICO-Esprit) option is installed.

NOTE: If any button is grayed out, that particular feature may not be enabled. Contact Respirationics Technical Service at 1-800-345-6443.



Summary of Trended Data Information	
Information type	Description
<i>Pt Data</i> , <i>Settings</i> , or <i>Mech</i> button 	Selects the category of data to choose from (the current selection is highlighted). Changing the category causes a different set of parameter select buttons to appear.
Parameter select button	Selects which parameter to display as trended data (the current selection is highlighted in the data category list). For a complete list of parameters, see Table 13.K3.
>> button 	Appears if more than one page of trended data is available for the selected category (the next page displays a << button to return to the previous page).
Cancel button 	Exits the <i>Trended Data</i> pop-up window without making changes.
Accept button 	Confirms the selected parameter and exits the <i>Trended Data</i> pop-up window.

Table 13-11: Summary of Trended Data Information

Using the Manual Rescale Function

The Manual rescale buttons (Figure 13-36) allow you to adjust the vertical scale for most waveforms. Press the top half of the scale to change the upper limit, and the bottom half of the scale to change the lower limit. A pop-up window allows you to adjust the scale. Press the *Cancel* button to exit the pop-up window without making changes, or press *Accept* to select the new value and exit the pop-up window.

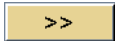
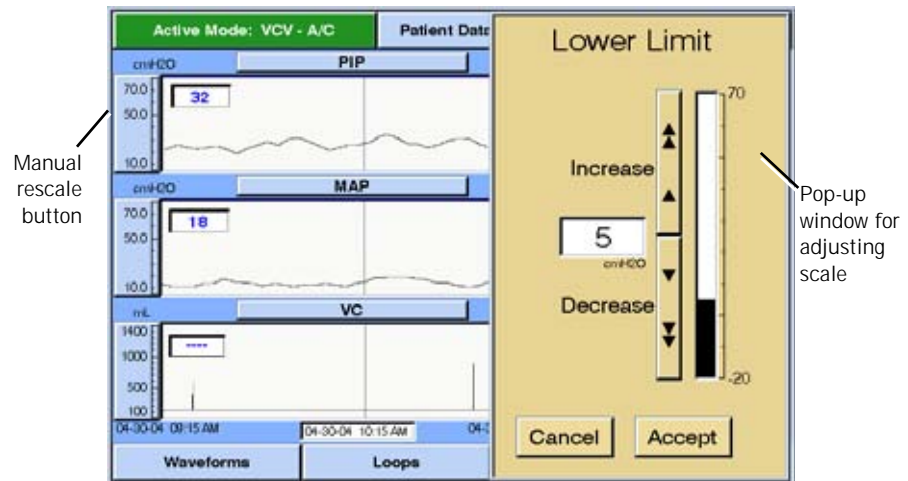

Figure 13-36: Manually Rescaling a Vertical Axis on the Trending Screen

Changing the Cursor Position

The Cursor arrow buttons (Figure 13-36) allow you to adjust the position of the cursor for all three waveforms. You can also turn the knob to adjust the cursor position.

The data display window for each waveform shows the value of the data at the time indicated by the cursor position. A window at the bottom of the screen shows the time reflective of the cursor position.

Alarms are represented as active or inactive. To see which alarm was active at a given time, move the cursor to that time. Up to three alarms that were active appear in the data display window. They appear in order of priority.

Maneuvers display the value obtained when the maneuver was performed. No data is displayed for times when the maneuver was not performed.

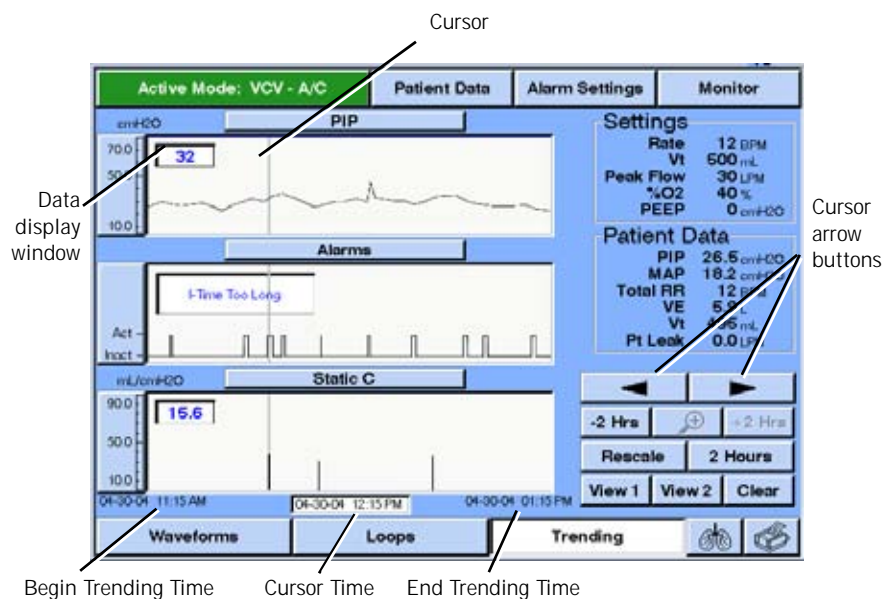

Figure 13-37: Changing Cursor Position on the Trending Screen

Selecting the Time Scale

The selected time scale (Figure 13-38) applies to all three waveforms on the *Trending* screen. To choose a different scale, press the Time scale button: a *Time Scale* pop-up window allows you to select another scale.

Press the *Cancel* button to exit the pop-up window without making changes, or press *Accept* to select the new value and exit the pop-up window. The new value will appear on the time scale button.

NOTE: If there is not enough recorded data to display a time scale, then its respective button is grayed out.

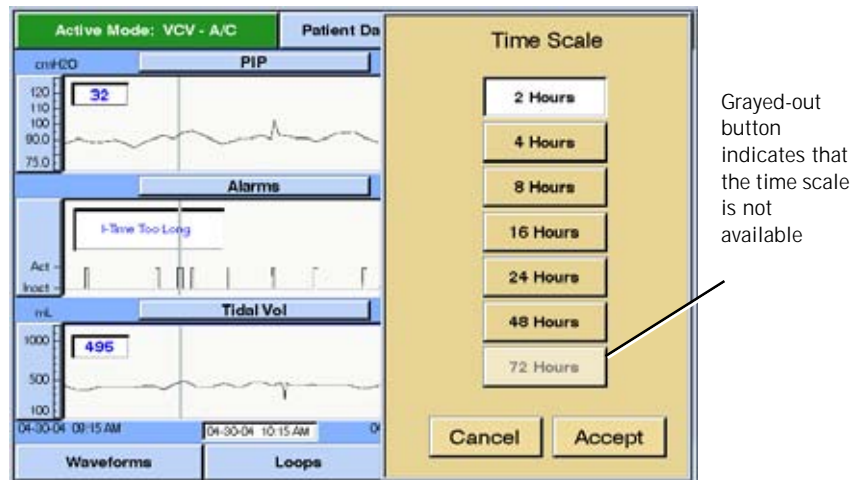

Figure 13-38: Selecting the Time Scale for the Trending Screen

Using the +2 Hrs/-2 Hrs Hrs buttons



The +2 Hrs and -2 Hrs buttons shift all three waveforms forward or backward by two hours without changing the time scale. If you press and hold the buttons, the time scale shifts every 1/2 second. If less than 2 hours of data exist, the waveform shifts by the amount of available data. The buttons are grayed if the waveform cannot shift any further.

Using the Zoom Function



The Zoom button allows you to zoom in on trended data by switching the time scale to two hours, centered around the cursor position. If the current time scale is two hours, the zoom button is grayed.

When the Zoom button shows a magnifying glass with a plus (+) sign, the “zoom in” function is available. Once zoomed in, the button changes to a magnifying glass with a minus (-) sign to indicate that the “zoom out” function is available, and the *Time* and *View* buttons are disabled. Zooming out returns the waveforms to their previous time scale and all buttons to their previous states.

Using the Rescale Button



The *Rescale* button automatically adjusts the vertical axis for all three waveforms. The software determines a scale based on the minimum and maximum values of the data to display an optimal view.

Using the *View 1/View 2* buttons

The *View 1* and *View 2* buttons make it possible for the user to store three trending waveforms and a time scale and recall them with a press of a button.

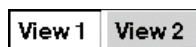

A highlighted *View* button indicates that a preselected view is being displayed.



If neither button is highlighted, the view (waveform(s) and/or time scale) has been changed from the preselected view. Touch the *View* button to revert to the preselected view.

To store settings to one of the *View* buttons, select the desired waveforms and timescale then press and hold the *View 1* or *View 2* button for three (3) seconds. A pop-up window asks you to confirm that you want to change the preselected view. Press *Yes* to reconfigure the preselected view, or *No* to exit the pop-up window without making changes. Repeat the process to store settings to the other *View* button.

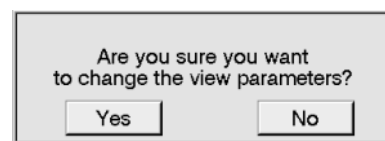

Using the *Clear* button



The *Clear* button allows you to clear all stored data for trending. Press *Clear* between patients or to erase all of a patient's previously stored data.

When you press *Clear*, a pop-up window asks you to confirm that you want to erase all stored data. Press *Yes* to clear the data, or *No* to exit the pop-up window without clearing data.

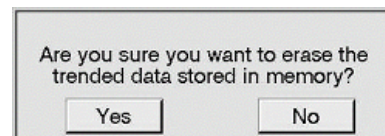

Alarms during Trending

If an alarm occurs while viewing the Trending screen, an *Alerts* window replaces the *Settings* window, and lists up to four currently active alarms. If the alarm conditions no longer exist, press **Alarm Reset** to close the *Alerts* window and restore the *Settings* window.

PCMCIA Card

The Trending option with the ventilator requires the use of a Respironics approved 16 MB flash memory card. The card must be used in conjunction with an adaptor for the PCMCIA slot at the back of the ventilator. The order number for the card and adaptor is P/N 1014293.

WARNING: The cover plate for the PCMCIA slot at the back of the ventilator must be replaced after the adaptor and card are installed. This is to protect the ventilator.

CAUTION: The PCMCIA card should only be removed by trained service personnel once power to the ventilator is off.

Trending Not Available

This *Trending Not Available* message indicates a problem with Trending option data storage.

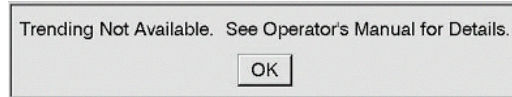

This message may appear if:

- the PCMCIA card installed for the Trending option is removed,
- the PCMCIA card includes unrecognizable or corrupted files, or
- the PCMCIA card does not contain enough memory.
- the internal clock setting was moved back by more than 1.25 hours and trending data was not erased.

Contact Respirationics Technical Support for more information.

Specifications

Data collection and display	The system collects numeric data every 20 seconds. Alarms are considered active if they occurred at any time during the previous 20-second interval.
	If the selected time scale is 2 hours, each data point on a waveform represents 20 seconds. As the scale is increased, each data point represents a longer interval.
	Data is periodically refreshed if there is no user interaction.
Display time-outs	The <i>Trending</i> screen automatically reverts to the Monitor screen if 15 minutes elapse without user interaction.
	Pop-up windows are cleared from the display if 2 minutes elapse without user interaction, and any pending changes are cancelled.

Table 13-12: *Trending Data Specifications (Sheet 1 of 4)*

Trended data	The Trending option simultaneously trends 32 parameters from four categories: patient data, settings, lung mechanics (<i>Mech</i>) and (NICO). Parameters that are not currently displayed are stored in memory for viewing.
Trended data: Pt Data	<p>PIP (peak inspiratory pressure)</p> <p>MAP (mean airway pressure)</p> <p>Tidal Vol (exhaled tidal volume)</p> <p>Total VE (total minute volume)</p> <p>Spont VE (spontaneous minute volume)</p> <p>Tot & Spt VE (both spontaneous and total minute volume displayed on the same waveform)</p> <p>Total Rate (measured total respiratory rate)</p> <p>Spont Rate (measured spontaneous respiratory rate)</p> <p>Tot & Spt Rate (measured spontaneous and total rate displayed on the same waveform)</p> <p>Pe End (measured end expiratory pressure)</p> <p>I:E Ratio (inspiratory to expiratory ratio)</p>

Table 13-12: Trending Data Specifications (Sheet 2 of 4)

Trended data:	Alarm
Pt Data (continued)	(alarm occurrence)
	%O₂ (percentage of oxygen delivered)
	F / V_t (rapid shallow breathing index)
	T_i/T_{tot} (the ratio of inspiratory time to total respiratory cycle time for spontaneous breaths)
	Peak L-Flow (peak flow of gas during the inspiratory phase)
	% Pt Trigger (percentage of patient triggered breaths)
	Pt Leak (patient leak)

Trended data:	Set Tidal Vol
Settings	(set tidal volume, only available in VCV mode)
	Set Pressure (set pressure, only available in PCV mode)
	Set PEEP (set PEEP level, only available in VCV or PCV mode)
	Set % O₂ (set delivered O ₂ %)
	Set PSV (set pressure support, only available in VCV mode)
	Set IPAP (set inspiratory positive airway pressure level, only available in NPPV mode)
	Set EPAP (set expiratory positive airway pressure level, only available in NPPV mode)
	Set I-Time (set inhalation time, only available in PCV or NPPV mode)

Table 13-12: Trending Data Specifications (Sheet 3 of 4)

Trended data: <i>Mech</i>	<i>Static C</i> (static compliance maneuver, only available if Mechanics option is installed)
	<i>Static R</i> (static resistance maneuver, only available if Mechanics option is installed)
	<i>VC</i> (vital capacity maneuver, only available if Mechanics option is installed)
	<i>MIP</i> (maximum inspiratory pressure maneuver, only available if Mechanics option is installed)
	<i>PO.1</i> (PO.1 maneuver, only available if Mechanics option is installed)
	<i>Dynamic C</i> (dynamic compliance, only available if Mechanics option is installed)
	<i>Dynamic R</i> (dynamic resistance, only available if Mechanics option is installed)
	<i>Auto PEEP</i> (expiratory hold)
	Trended data: <i>NICO</i>
	<i>SpO₂</i> (O ₂ Saturation, only available if the respiratory profile monitor interface (NICO-Esprit) option is installed)
	<i>ETCO₂</i> (End Tidal CO ₂ , only available if the respiratory profile monitor interface (NICO-Esprit) option is installed)
	<i>VCO₂</i> (CO ₂ Elimination, only available if the respiratory profile monitor interface (NICO-Esprit) option is installed)
	<i>Vtalv</i> (Alveolar Tidal Volume, only available if the respiratory profile monitor interface (NICO-Esprit) option is installed)
	<i>Mvalv</i> (Alveolar Minute Volume, only available if the respiratory profile monitor interface (NICO-Esprit) option is installed)
Time scales	Selected time scales apply to all displayed waveforms: 2, 4, 8, 16, 24, 48, or 72 hours.

Table 13-12: Trending Data Specifications (Sheet 4 of 4)

(This page is intentionally blank.)

Flow-Trak[®] Option

Flow-Trak provides additional flow to Volume Control Ventilation (VCV) breaths. It allows the patient to draw additional flow or volume as desired.

Ventilators with Flow-Trak installed are identified by the option label as seen in Figure 13-39.

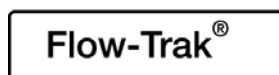

Figure 13-39: Flow-Trak option label

Once the Flow-Trak option has been loaded on the ventilator it is active. Follow these steps to turn Flow-Trak Off and On:

1. While in VCV, press the **Peak Flow** settings button.
2. Press the **Ftrak OFF** button.
3. Press the **Accept** button.

Use these same steps pressing **Ftrak On** to turn Flow-Trak on.

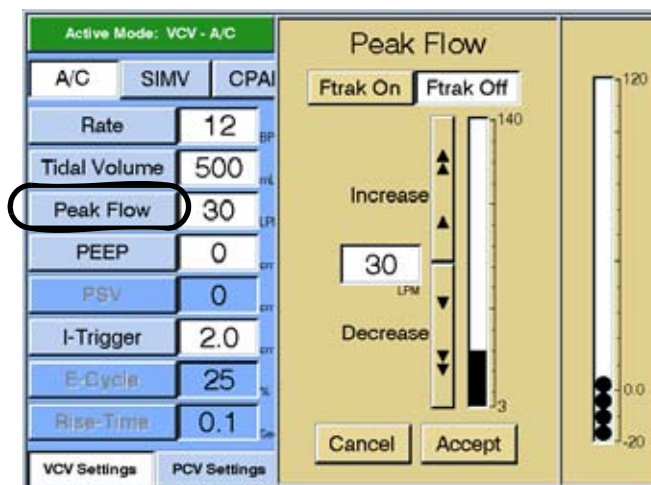

Figure 13-40: Turning off the Flow-Trak Option

Flow-Trak will stay resident on the ventilator when shut down and restarted. That is, if Flow-Trak is OFF when the ventilator is shut down then it will be OFF the next time the ventilator is started.

NOTE: If the **Ftrak On** button is grayed out in the settings window (Figure 13-41) then the Flow-Trak Option has not been installed. Contact Respiration Customer Service
 Within the U.S.A. 1-800-345-6443
 Outside the U.S.A. 724-387-4000

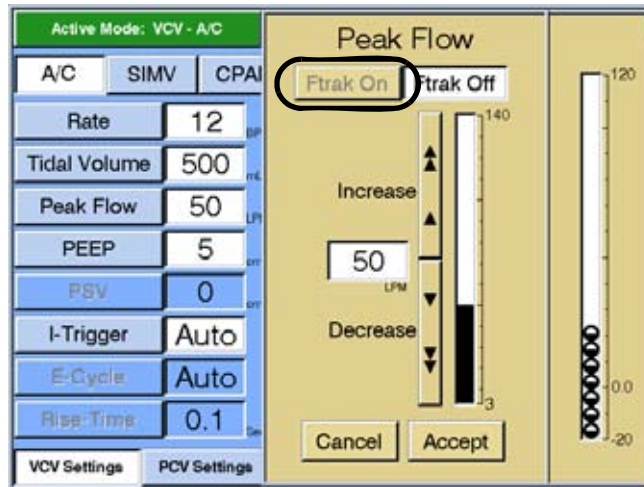

Figure 13-41: FTrak On Button Grayed Out, Flow-Trak is Not Loaded

On the Screen

When a patient initiates a Flow-Trak breath the ventilator screen shows the Breath Indicator bubble change from mandatory (Mand) or Assist to spontaneous (Spont).



Figure 13-42: Breath Indicator During Flow-Trak Breath

Breath Delivery

The Flow-Trak option allows the ventilator to give additional flow to patients who are not receiving the flows or volumes they desire by monitoring the pressure during a mandatory or assist breath. If the patient draws more flow or volume than what has been set, the inhalation pressure drops and Flow-Trak is initiated. The target pressure during Flow-Trak is 2 cmH₂O above PEEP. If the patient's effort to draw flow or volume drops below the set flows or volumes the ventilator returns to VCV.

The ventilator cycles to exhalation only if the set tidal volume plus compliance and BTPS compensation has been delivered (unless HIP has been met). If the patient effort ceases and set volume has not been met, the breath will continue to deliver flow until volume has been met.

Flow-Trak Cycling	
Condition (following the delivery of set Vt)	Response
The delivered flow meets the exhalation flow threshold. The exhalation threshold is either the flow trajectory that would have been followed had there not been a Flow-Trak breath or 25% of measured peak flow (whichever is larger).	The ventilator transitions to exhalation.
Exhalation effort detected (pressure exceeds 4.5 cmH ₂ O above PEEP).	The ventilator transitions to exhalation.
HIP condition has been met.	The alarm sounds and ventilator transitions to exhalation. See "Alarms" on page 13-86.
I-Time too long condition has been met.	The alarm sounds and ventilator transitions to exhalation. See "Alarms" on page 13-86.

Table 13-13: Breath Transitions

If the actual I-Time is greater than the calculated I-Time, the next scheduled mandatory inspiration is postponed to ensure exhalation time.

NOTE: In VCV, the calculated I-Time is based on the set tidal volume, peak flow, and waveform shape.

Inspiratory Hold

Inspiratory hold is only allowed if the actual I-Time is less than or equal to the calculated I-Time.

Respiratory Mechanics

The Flow-Trak option affects the following Respiratory Mechanics features.

Respiratory Mechanics Maneuvers with Flow-Trak	
Maneuver	Affect of Flow-Trak
Static C & R	The maneuver is cancelled if the patient initiates a Flow-Trak breath. A message appears when the maneuver is cancelled due to the change in breath type.
Dynamic C & R	Dynamic C & R are not calculated for Flow-Trak breaths.
Ti/Ttot	Ti/Ttot is not calculated for Flow-Trak breaths.
Peak Lung Flow	Peak Lung Flow is calculated for Flow-Trak breaths.

Table 13-14: Respiratory Mechanics Maneuvers with Flow-Trak

Alarms

The Flow-Trak option does not change the ventilator alarms with the exception of those alarms found below in Table 13-15:. For a complete listing of ventilator alarms and descriptions see Chapter 9, "Alarms", Table 9-1: "Alarm Alert Messages".

Flow-Trak Affected Alarms	
Alert Message	Description
I-Time too long	The breath transitions from inhalation to exhalation when 3.5 seconds has passed for adults or 2.5 seconds for pediatrics from the start of the mandatory breath. If the operator's settings result in a calculated I-Time > 3.5 seconds for adults or 2.5 seconds for pediatrics, then the calculated I-Time is the cycling criteria.
Low Inspiratory Pressure	Not available for the Flow-Trak triggered breath only.

Table 13-15: Flow-Trak Affected Alarms

NOTE: The I-Time too long alarm and/or the Low Inspiratory Pressure alarm will sound if a circuit disconnect were to occur.

Respiratory Profile Monitor Interface (NICO-Esprit) Option

The respiratory profile monitor interface (NICO-Esprit) software allows the ventilator and the respiratory profile monitor to exchange information via a bidirectional RS-232 serial link. Through this link, the ventilator supplies the monitor with breath type and FIO₂ information and in turn, the monitor provides the ventilator with data for trending parameters related to measuring CO₂ elimination (VCO₂).

System Requirements

The following hardware and software is required for the proper use of the respiratory profile monitor interface:

Respiratory Profile Monitor Interface (NICO-Esprit) Requirements	
Monitor	
NICO Monitor, Model 7300	Part number varies by language
NICO ₂ Monitor, Model 7600	
Respironics V200 Ventilator	
Trending option loaded and enabled	
Respironics V200 ventilator with the respiratory profile monitor interface option enabled.	
NOTE:	Ventilators with the respiratory profile monitor software installed are identified by an option label located near the power switch.
	
Accessories	
RS-232 serial communications 3' cable	1018292
WARNING: Use only Respironics approved cables when connecting to the communications port.	
Mounting kit, respiratory profile monitor	10060784

Table 13-16: respiratory profile monitor Interface Option Requirements

Communications

When the respiratory profile monitor interface (NICO-Esprit) option is installed, the RS-232 communications port is configured for all communications functions in the following manner:

Ventilator RS-232 Communications Port Settings	
Specification	Setting
Baud Rate	19200
Data Bits	8
Parity	None
Stop Bits	1

Table 13-17: Ventilator RS-232 Communications Port Settings

NOTE: The respiratory profile monitor interface (NICO-Esprit) option uses the communications port on the ventilator exclusively. The respiratory profile monitor interface (NICO-Esprit) option and the RS-232 Communications Option 2 cannot be installed on the same ventilator.

Hardware Setup

Once the software is loaded on the ventilator, the necessary hardware can be attached.

1. Attach the respiratory profile monitor to the mounting bracket, and then attach the assembly to the ventilator. Assembly instructions are included with the bracket.

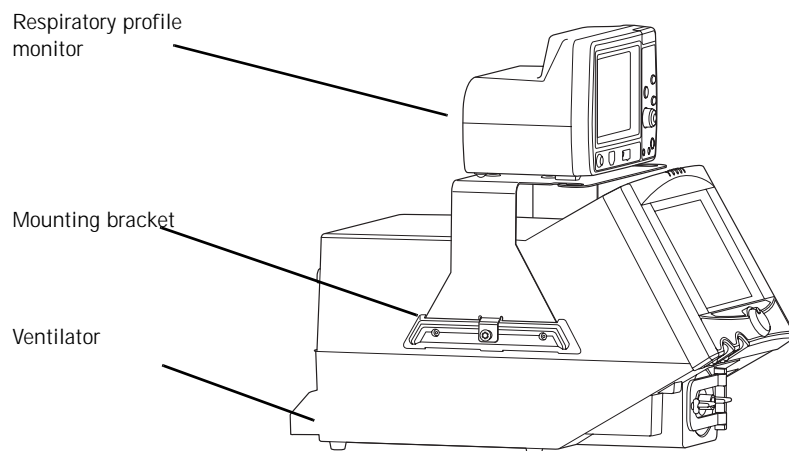

Figure 13-43: Assembled Monitor, Bracket, and Ventilator

WARNING: Always turn the ventilator power OFF before connecting additional equipment.

2. Attach one end of the RS-232 serial communications cable to the RS-232 port 1 or 2 on the back of the respiratory profile monitor. See Figure 13-44.
3. Attach the other end of the RS-232 serial communications cable to the serial communications port on the back of the ventilator. See Figure 13-44.

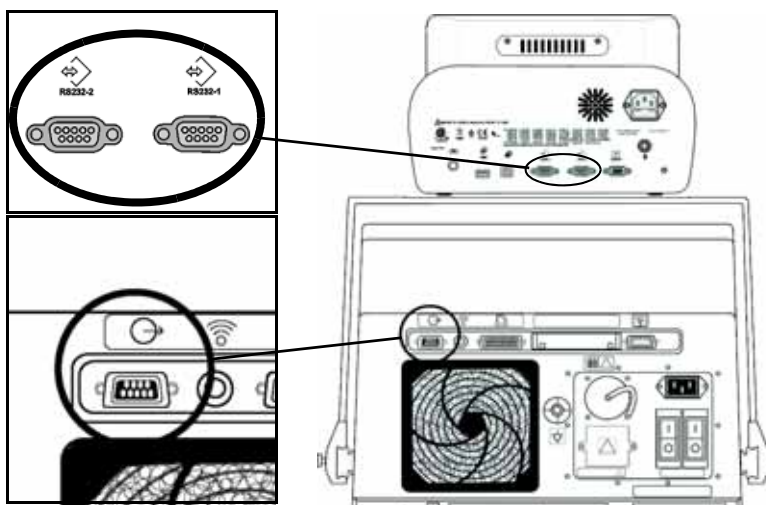

Figure 13-44: RS-232 Communication Ports for the Monitor and the Ventilator

4. Connect the patient circuit to the ventilator.
5. Power up the ventilator if not already operating.

NOTE: When powering on the ventilator for the first time after installing the respiratory profile monitor software, the Trending Memory Card must be reformatted. Press YES when asked the question:



-
6. Power up and connect the monitor according to the user's manual for your Respirationics respiratory profile monitor.
 - Inspect the monitor before powering up.
 - Press the **Operate/Standby** key to turn the monitor on.

Options and Accessories

- Connect the sensors to the monitor, ventilator circuit, and patient according to the *Respiratory Monitoring* section of the user's manual for your Respirationics respiratory profile monitor.
- 7. Select the NICO-Esprit interface on the respiratory profile monitor.
 - Press the **MENU** key to activate the **SELECT A SCREEN** menu.

SELECT A SCREEN	
CO ₂ /SpO ₂	TREND
FLOW/PRESSURE	TABULAR DATA
FLOW/PRES/VOL	VOLUMETRIC CO ₂
V̇CO ₂ /MVa1v TREND	NUMERICS
Vt/Vd TREND	SET ALERTS
	SETUP

Figure 13-45: Select A Screen Menu screen

- Turn the knob to highlight **SETUP** and then press the knob. The SETUP screen appears.
- Turn the knob to highlight **INPUT/OUTPUT** and then press the knob. The INPUT/OUTPUT screen appears.

INPUT/OUTPUT SETUP	
ANALOG OUT 1	RS232-2
ANALOG OUT 2	RS232-3
ANALOG OUT 3	
ANALOG OUT 4	
ANALOG CAL.	
EXIT	

Figure 13-46: Input/Output Setup Screen

- Turn the knob to highlight **RS232-2** and then press the knob. The RS232-2 screen appears
- Turn the knob to highlight **ESPRIT** and then press the knob. The INPUT/OUTPUT screen appears.

RS232-2
TURN KNOB TO ADJUST PUSH KNOB TO ACCEPT
ESPRIT

Figure 13-47: ESPRIT Choice for RS232-2 Port Screen

- Turn the knob to highlight **EXIT** and then press the knob. Turn the knob to highlight **EXIT** again and then press the knob. The monitor returns to the SETUP screen.

The ventilator and the respiratory profile monitor will begin communication within 60 seconds.

RS-232 Communications

The bidirectional communication between the respiratory profile monitor and ventilator is initiated by the monitor. The ventilator recognizes the connect request message from the monitor and responds.

Information Transferred from the Respiratory Profile Monitor to the Ventilator

The respiratory profile monitor provides the ventilator with the data listed in the following table. The monitor sends the average value for each parameter for the previous 60 seconds.

Information Transferred from the Respiratory Profile Monitor to the Ventilator	
Data	Description
CO-a	Cardiac Output Average NOTE: Available only when the Cardiac Output option is installed.
SpO ₂	O ₂ Saturation
ETCO ₂	End Tidal CO ₂
VCO ₂	Volume CO ₂
Vtalv	Alveolar Tidal Volume
MValv	Alveolar Minute Volume

Table 13-18: Information Transferred from the Monitor to the Ventilator

Information Transferred from the Ventilator to the Respiratory Profile Monitor

The ventilator provides the respiratory profile monitor with the following information.

Information Transferred from the Ventilator to the Respiratory Profile Monitor	
Data	Description
Breath Type	Mandatory, Assisted, Spontaneous, or Supported
FIO ₂	The percentage of oxygen in the gas delivered to the patient.
	NOTE: If the optional oxygen sensor for the ventilator is used, this number will be the FIO ₂ measured by the sensor. If the optional oxygen sensor is not used, this will be the set FIO ₂ .

Table 13-19: Information Transferred from the Ventilator to the Monitor

Trended NICO Data

The ventilator captures the data sent from the respiratory profile monitor and stores it on the PCMCIA card (PC Card). The Trending screen makes it possible to display ventilator and monitor information for intervals from 2 to 72 hours.

To access the respiratory profile monitor trended data:

1. Touch the **Patient Data** button at the top of any settings screen (VCV, PCV, or NPPV).

NOTE: If the Graphics option is not installed, the Graphics button is grayed out and Trending is only accessible from the *Patient Data* screen.

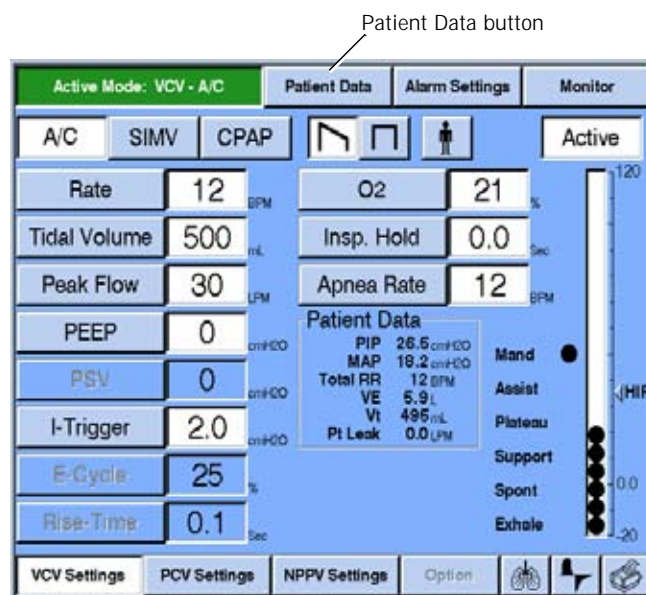

Figure 13-48: VCV Settings Screen

2. Touch the *Trending* button to display the *Trending* screen (Figure 13-33).

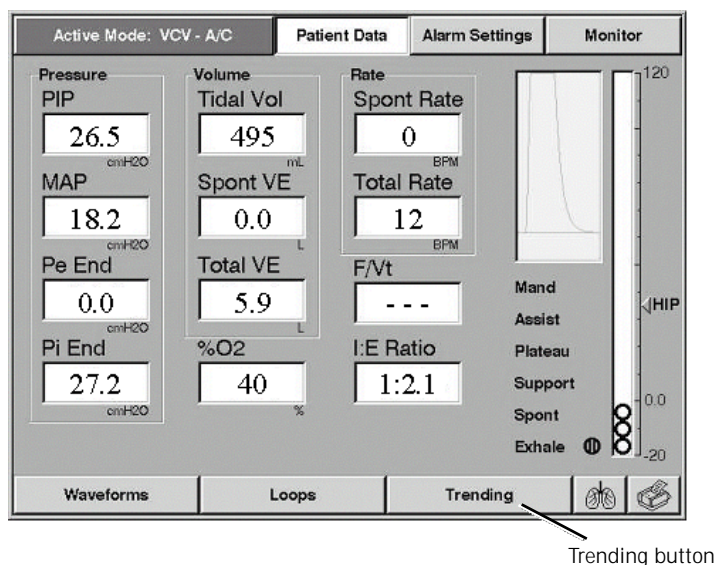

Figure 13-49: Patient Data Screen

The *Trending* screen (Figure 13-34) displays three trending waveforms as well as a summary of ventilator settings and patient data. You can change the waveforms and time scale at any time.

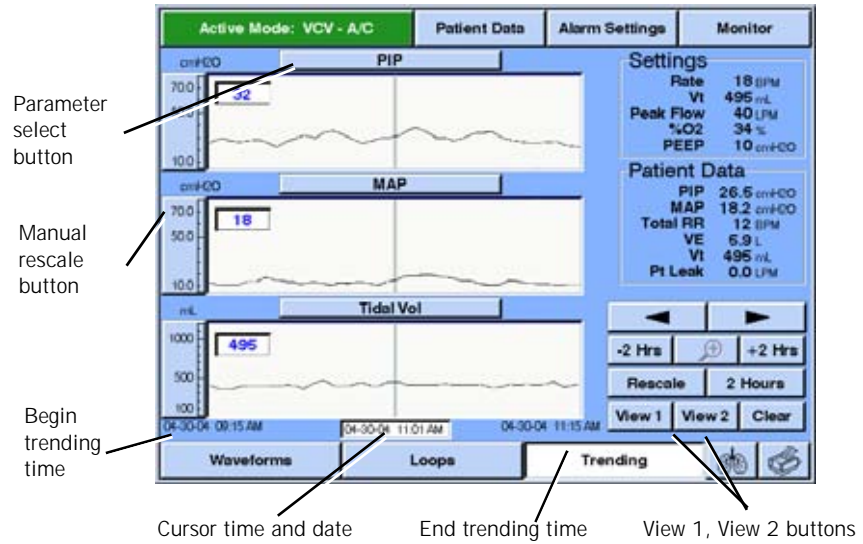

Figure 13-50: Trending Screen

The parameter select button above each waveform shows the name of the currently displayed parameter. To choose a different parameter for display, press the button above the waveform. The *Trended Data* pop-up window appears showing the available data choices.

3. Press the **NICO** button on the Trended Data pop-up window to view the available parameters. See Figure 13-51.
4. Select a parameter button then press **Accept** or **Cancel** to return to the Trending Data screen.

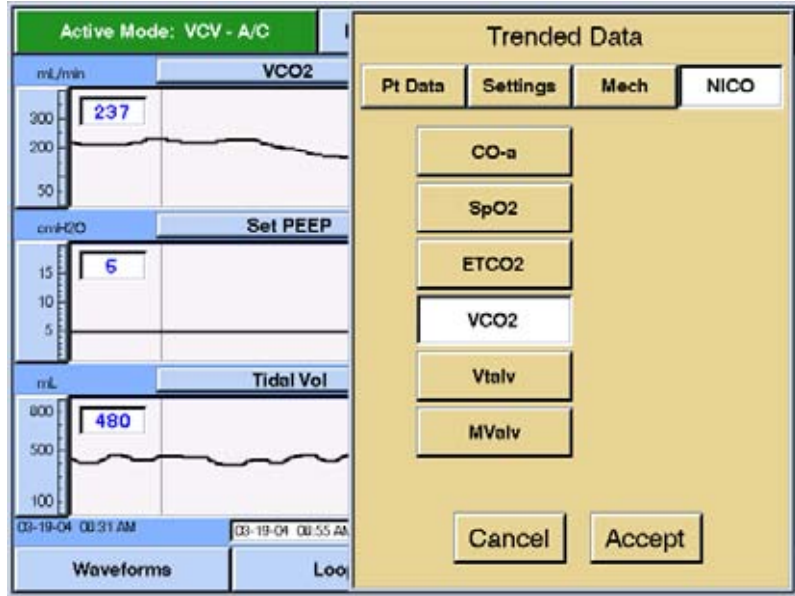

Figure 13-51: Trended Data screen

NOTE: For more information regarding the Trending Data screen or using the Trending Option, refer to "Trending Option" on page 13-69.

Troubleshooting

Troubleshooting		
NICO button does not appear on the Trended Data screen	Probable Cause:	The ventilator may not have respiratory profile monitor interface software.
	What to Do:	Contact Respiration Technical Service: 1-800-345-6443.
NICO button on the Trended Data screen is grayed out	Probable Cause:	The respiratory profile monitor interface option is loaded but not enabled on the ventilator.
	What to Do:	Contact Respiration Technical Service: 1-800-345-6443.
Ventilator is not capturing data sent from the respiratory profile monitor	Probable Cause:	The bidirectional communication link is not functioning properly.
	What to Do:	Check that the RS-232 serial communications cable (P/N 1018292) is being used. Check cable connections. Perform the steps listed on page 13-90 and page 13-91 for setting up the monitor with the RS-232 input/output for the ventilator. Cycle the power on the monitor. If there is no improvement, Contact Respiration Technical Service: 1-800-345-6443.
The monitor displays the CHECK COMMUNICATION message	Probable Cause:	The bidirectional communication link is not functioning properly.
	What to Do:	Check that the RS-232 serial communications cable (P/N 1018292) is being used. Check cable connections. If there is no improvement, Contact Respiration Technical Service: 1-800-345-6443.
	Probable Cause:	The ventilator may not have respiratory profile monitor software.
	What to Do:	If the NICO button on Trended Data screen is grayed out, the respiratory profile monitor interface option is loaded but not enabled on the ventilator. Contact Respiration Technical Service: 1-800-345-6443.
Any other condition	What to Do:	Contact Respiration Technical Service: 1-800-345-6443.

Neonatal Option

The Neonatal option allows the Respironics V200 Ventilator to ventilate intubated neonatal patients with an ideal body weight range of 0.5 - 6.5 kg (1.10 - 14.33 lb.) and an endotracheal tube I.D. range from 2.5 - 4.0 mm. The option provides pressure control in A/C, SIMV, and Apnea ventilation and also provides pressure support in SIMV and CPAP. The Neonatal Option is not available in VCV or NPPV modes.

System Requirements

The Neonatal option requires the following software and accessories for proper use:

Neonatal option Requirements	
Respironics V200 Ventilator	
Neonatal option loaded and enabled.	
NOTE:	Ventilators with the Neonatal option software installed are identified by the option label located near the power switch.
	
Recommended Accessories	Part Number
Neonatal patient circuits (10 mm I.D.)	
Fisher & Paykel reusable circuit	900MR780
Hudson RCI disposable circuit	780-07
Fisher & Paykel disposable circuit	RT131 (RT125 is EU equivalent)
22mm, Male x Male Connector (Refer to Figure 13-52.) coupling, Straight Silicone	1002505 500-1000-43
NOTE:	We recommend using approved circuits or equivalent when connecting to the ventilator.

Table 13-20: Neonatal Option Requirements

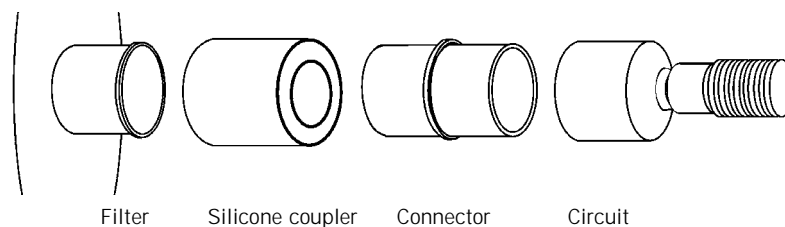

Figure 13-52: Circuit to Filter Connection

Changing Patient Types

The Neonatal option is available once the software option is installed. The current patient is identified by the icon found on any active ventilation type screen. In Figure 13-53 the neonatal patient type has been selected, which is identified by the neonatal patient type icon.

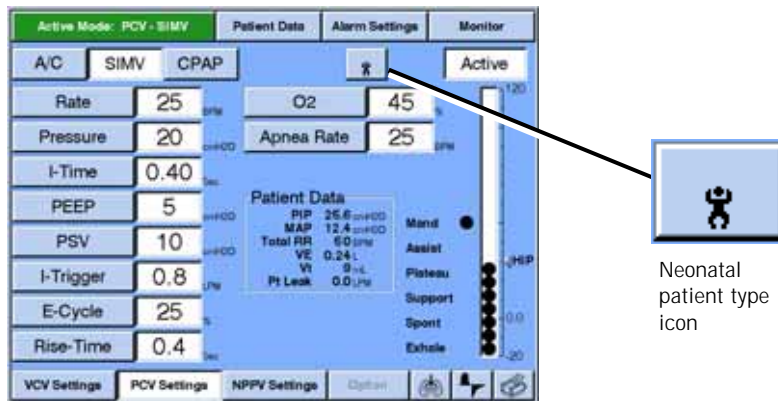

Figure 13-53: Identifying the Neonatal Patient Type

Changing to or from the neonatal patient type requires that the Short Self-Test (SST) or Extended Self-Test (EST) must first be run. Attempts to change patient types to or from the neonatal patient type while in the active ventilation type screen causes a message box to appear explaining that you must run SST or EST in order to change patient type.

Selecting Neonatal Patient Type

To select the neonatal patient type, you must enter Diagnostic Mode.

1. Power off the ventilator.
2. Power on the ventilator while holding down the **ALARM RESET** and **100% O₂** keys for approximately 5 seconds.

A message appears on the ventilator screen that prompts the user to 'Verify that the patient is disconnected prior to proceeding.' Press **OK** to enter Diagnostic Mode.

3. Once you've entered Diagnostic Mode, select either **SST** or **EST**.
4. Press **Start SST** (or if in EST, **Start EST**).
5. Select **Neonatal** patient type and then follow the remaining on-screen instructions.

The next time the ventilator is powered on, it will be set for neonatal patients. For optimum performance use a Neonatal patient circuit (10 mm I.D.) with compliance compensation enabled.

These same steps apply when changing to Adult or Pediatric patient type from Neonatal.

Heated Filter Test

The heated filter test in EST for adult and pediatric patient types automatically tests for pressure drop of the exhalation filter. This portion of EST is not possible with neonatal circuits. We recommend running this test according to the filter manufacturers recommendations. The following steps can be run in diagnostics mode:

1. Power off the ventilator.
2. Power on the ventilator while holding down the **ALARM RESET** and **100% O₂** keys for approximately 5 seconds.

A message appears on the ventilator screen prompting the user to 'Verify that the patient is disconnected prior to proceeding.' Press **OK** to enter Diagnostic Mode.

3. Once you've entered Diagnostic Mode, select the **HARDWARE** screen.
4. Press the **SAFETY** button so that it has a white background.
5. Attach a length of 22 mm I.D. tubing to the gas outlet port of the ventilator.
6. Set the air flow to 100 LPM. Record what the inhalation pressure sensor is reading. See Figure 13-54.
7. Attach the filter to the end of the length of 22 mm I.D. tubing and again record the inhalation pressure sensor reading. See Figure 13-54.

The difference between the first pressure reading and second pressure reading should not be greater than 4 cmH₂O (or manufacturer's recommendations).

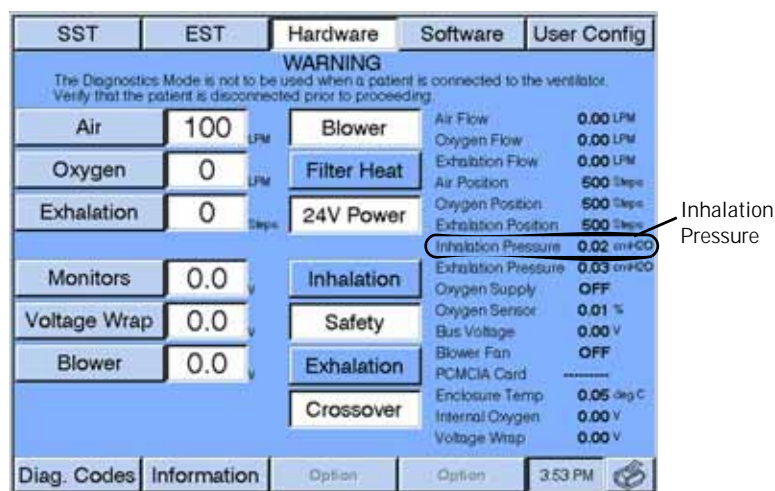

Figure 13-54: Hardware Screen in Diagnostics Mode, Inhalation Pressure reading

Initial Neonatal Settings

When the ventilator is first powered on and the neonatal patient type is selected, the initial startup settings found in Table 13-21: are applied. Each subsequent startup will display the settings from the last use of the ventilator of that patient type with the exception of O₂. The last O₂ setting used on the ventilator will remain regardless of patient type.

Initial Patient Settings, Ranges		
Ventilation Settings	Value	Ranges
Ventilation Mode	PCV - SIMV	AC, SIMV, CPAP
Rate	20 BPM	1 - 150 BPM
Pressure	10 cmH ₂ O	5 - 100 cmH ₂ O
I-Time	0.3 Sec	0.1 - 2.0 Sec
PEEP	3 cmH ₂ O	0 - 35 cmH ₂ O
PSV	0 cmH ₂ O	0 - 100 cmH ₂ O
I-Trigger	2.0 L/Min	0.3 - 10.0 L/Min
E-Cycle	25%	10 - 80%
Rise-Time	0.2 Sec	0.1 - 0.5 Sec
O ₂ %	same as last O ₂ setting	21 - 100%
Apnea Rate	20 BPM	1 - 80 BPM
Alarm Settings	Value	Ranges
High Press	30 cmH ₂ O	10 - 105 cmH ₂ O
Low Insp Press	5 cmH ₂ O	3 - 105 cmH ₂ O
Low Peep	0 cmH ₂ O	0 - 35 cmH ₂ O
Low Vt Mand	10 mL	0 - 300 mL
Low Vt Spont	3 mL	0 - 300 mL
High Rate	150 BPM	0 - 150 BPM
High VE	1.2 L	0.00 - 5.0 L
Low VE	0.3 L	0.00 - 5.0 L
Apnea	20 Sec	10 - 60 Sec
I-Time Too Long	sounds after 1.5 Sec of spont breath	

Table 13-21: Initial Neonatal Patient Settings

NOTE: Patient data ranges and accuracies can be found in Chapter 12, "Technical Specifications" with the exception of the Exhaled Tidal Volume. The accuracy for exhaled Tidal Volume is $\pm(4\text{ml} \pm 10\%)$

NOTE: Neither Respiratory Mechanics nor Expiratory Hold are active when the neonatal patient type is selected. Flow trigger is the only trigger type available. All other features apply.

Percent Leak

When the neonatal software option is loaded on the ventilator, a % Leak window appears on the Patient Data screen. The window displays the estimated leak of the delivered volume as a percentage. The % Leak value is updated at the beginning of each inhalation. The % Leak is available for all patient types when the neonatal software option is loaded. While the estimate for percent leak is not a precise measurement it can be used to trend relative changes in leak delivered volume.

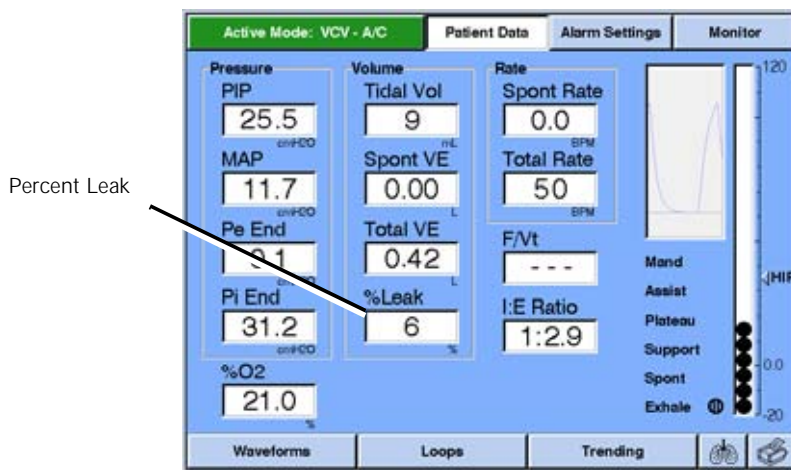

Figure 13-55: Patient Data Screen With % Leak

Patient Leak Values

Patient Leak values (as seen in the Patient Data window, Figure 13-56) between 0 and 1 LPM are rounded values. Refer to Chapter 7, "Operating Theory", for more information about *Patient Leak Display*.

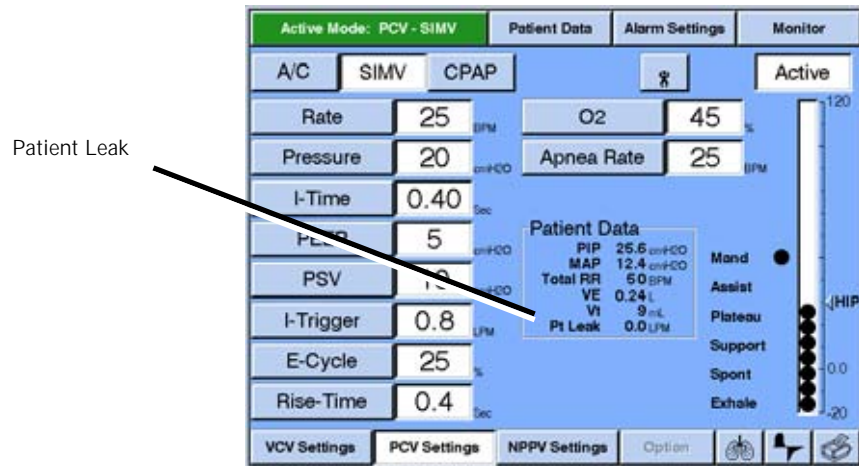

Figure 13-56: Patient Data Window

Speaking Mode Option

The Speaking Mode software option for the Respirationics V200 Ventilator allows tracheostomized adult and pediatric patients who meet certain criteria to vocalize without the need of a speaking valve. The Speaking Mode software, when activated, closes the ventilator's exhalation valve, keeping it closed during the expiratory phase. This action redirects airflow around the deflated balloon cuff on the tracheostomy tube, through the larynx and pharynx, and out through the mouth. As the air flow passes through the vocal cords, speech is returned.

Speaking Mode provides pressure control and volume control in A/C, SIMV, CPAP, Pressure Support, and in the Flow-Trak ventilator option (if enabled).

Speaking Mode is not available in NPPV mode, Respiratory Mechanics, and Neonatal options.

Ventilators installed with Speaking Mode option software have the following identifying label located near the power switch:

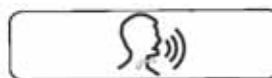

Figure 13-57: Speaking Mode Option Label

Warnings, Cautions, and Notes

Warnings

A warning indicates a condition that could cause injury to a patient or operator if instructions are not followed.

- Read and understand these *Speaking Mode Option* instructions before using Speaking Mode on a patient.
- Wait at least 72 hours after a tracheostomy before initiating Speaking Mode.
- Monitor patients with trained medical personnel when using Speaking Mode.
- COMPLETELY DEFLATE the tracheostomy tube cuff before activating Speaking Mode.
- Do not use while patient is sleeping, unresponsive, or comatose.
- Do not use with patients with upper airway obstruction.
- Do not use with foam cuff tracheostomy tubes.

Options and Accessories

- Do not use with neonatal tracheostomy tubes.
- Do not use on neonates.
- Do not inflate the tracheostomy tube cuff until Speaking Mode has been turned off.
- Do not use on patients who are dependent on PEEP therapy.
- Do not use with HME filters.
- Discontinue using Speaking Mode promptly and institute appropriate ventilation if the patient experiences difficulty or their status deteriorates from baseline parameters.
- Perform an airway patency test immediately after activating Speaking Mode.

NOTE: Speaking Mode is available ONLY in invasive ventilation mode.

Patient Preparation

Using Speaking Mode on a patient requires preparation before activating the mode. Refer to the *Sequence for Use* diagram in Figure 13-58 and follow the necessary steps before starting Speaking Mode and discontinuing Speaking Mode. The *Speaking Mode Clinical Guide* describes patient care steps in detail.

WARNING: Read and understand these Speaking Mode Option instructions before using Speaking Mode on a patient.

WARNING: Wait at least 72 hours after a tracheostomy before initiating Speaking Mode.

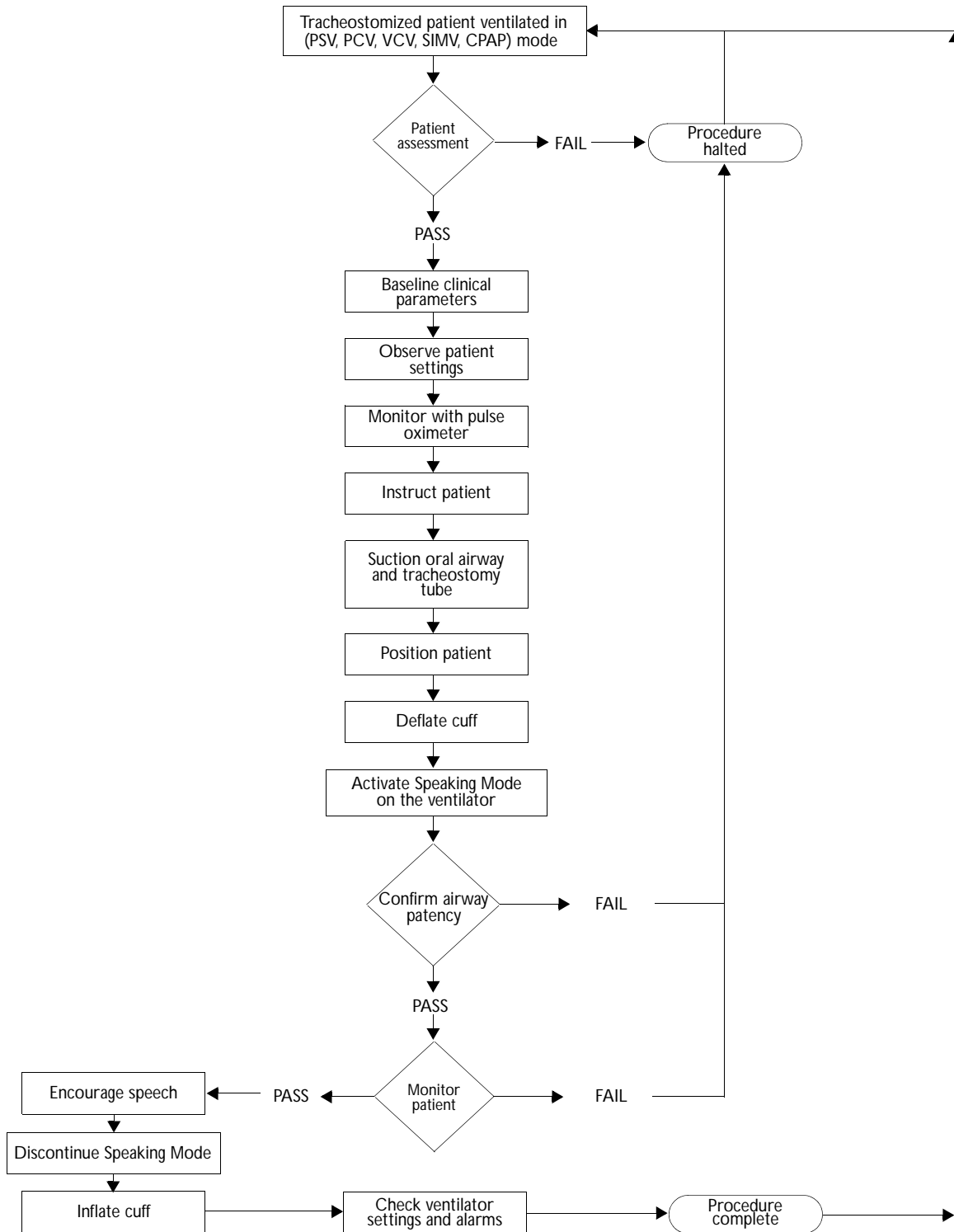

Figure 13-58: Speaking Mode Sequence for Use

Settings

Speaking Mode Ventilator Settings	
Available in Modes	Pressure Control Ventilation (AC, SIMV, and CPAP) Volume Control Ventilation (AC, SIMV, and CPAP) Pressure Support Ventilation (SIMV and CPAP) Apnea Ventilation
Patient Type:	Adults & Pediatrics
PEEP	Automatically reset to zero and low PEEP alarm is reset to zero
Trigger-type	Automatically will switch from flow triggering, if previously selected, to a pressure triggering of 1 cm H ₂ O
Alarm Changes	Exhaled volume alarms automatically change to delivered volume alarms
Patient Data	Trended and displayed values based on delivered volumes
Mechanics	Respiratory mechanics feature not available

Starting Speaking Mode

Prepare the patient and deflate the tracheostomy cuff.

1. Press the Speaking Mode button.

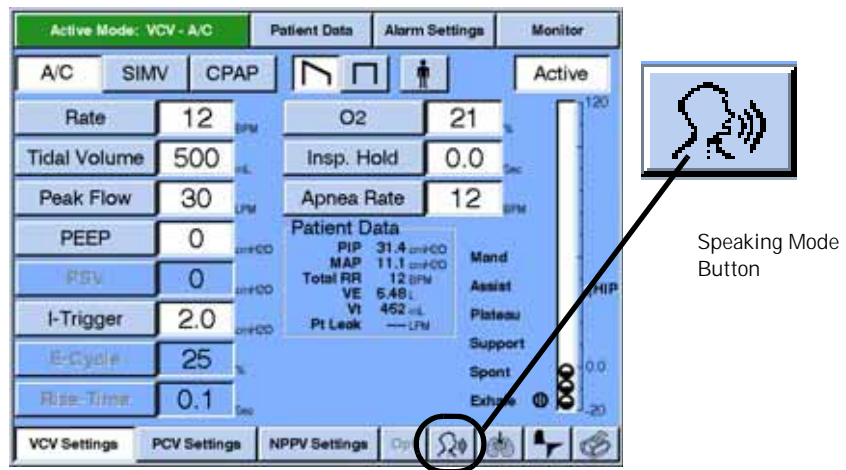

Figure 13-59: Speaking Mode Button

The first message box appears, *Turn Speaking Mode On?*

This message box explains the changes that will occur while the ventilator is operating in Speaking Mode.

2. Press **Continue** to continue or **Cancel** to exit Speaking Mode.



Figure 13-60: Turn Speaking Mode On? First Message Box

The second message box then appears with the same command, *Turn Speaking Mode On?*, reminding the user to:

Please be sure there is NO Speaking Valve installed and the tracheostomy cuff is deflated.

3. Press **Accept** to continue or **Cancel** to exit Speaking Mode.



Figure 13-61: Turn the Speaking Mode On? Reminder Second Message Box

Speaking Mode is ON when the Active Mode button in the upper left-hand corner of the screen is orange and the Speaking Mode button at the bottom of the screen has a white background.

Active Mode button is orange

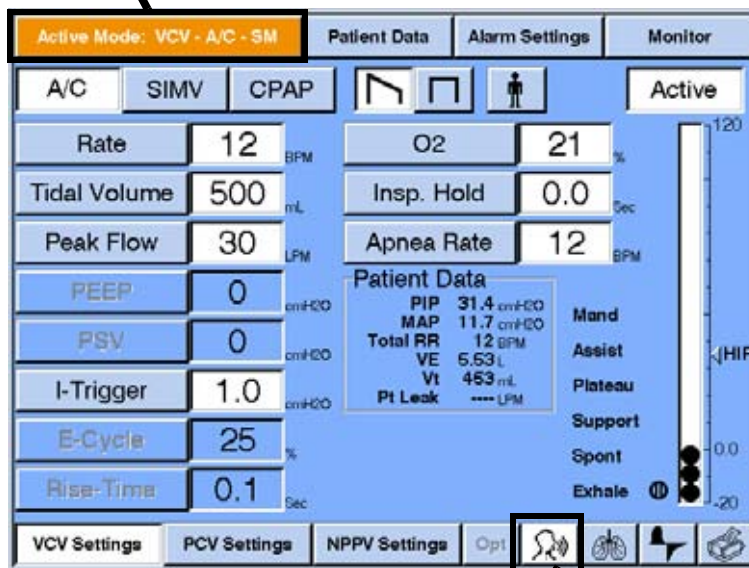

Speaking Mode button

Figure 13-62: How the Ventilator Screen Appears When Speaking Mode Is ON

4. We recommend reviewing alarm and ventilator settings at this time. Continue to monitor patient's respiratory effort and clinical status. If patient's respiratory efforts deteriorate, discontinue Speaking Mode. See "Discontinue Speaking Mode" on page 115.

Alarms

While in Speaking Mode, the ventilator switches all volumetric alarms from exhaled to delivered alarms. This means that all alarms that were triggered based on exhaled volumes will now be based on delivered volumes. These alarms include:

- Low Exhaled Minute Volume
- High Exhaled Minute Volume
- Low Exhaled Mandatory Tidal Volume
- Low Exhaled Spontaneous Tidal Volume

Disabled Alarms

The Low PEEP alarm is disabled while in Speaking Mode.

This alarm will appear “grayed out.” When the ventilator returns to PSV, PCV, VCV, SIMV, or CPAP operation, the current alarm settings will remain after Speaking Mode is discontinued.

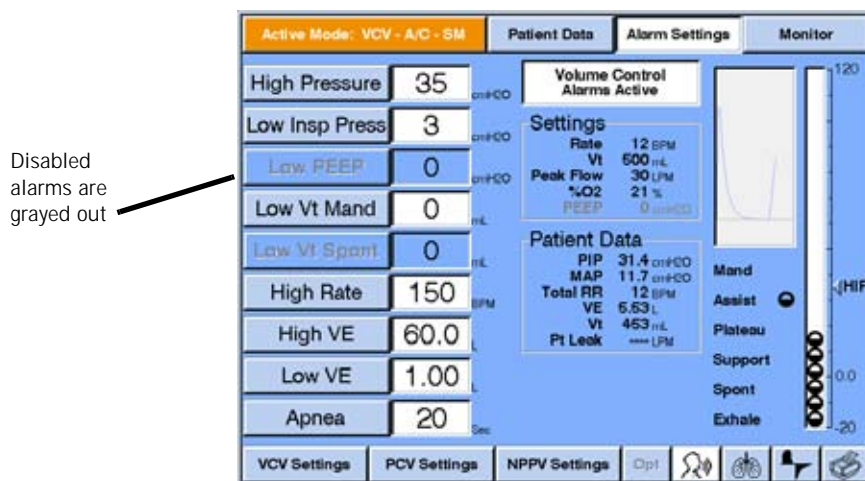

Figure 13-63: Alarm Settings Screen

Changes can be made to these disabled alarms while in Speaking Mode, but they will not take effect until Speaking Mode is discontinued.

Mode-Specific Alarms

Disconnect Alarm

If the tracheostomy tube becomes disconnected from the patient circuit, a high urgency *Disconnect Alarm* will sound. When the disconnect alarm is active, the ventilator continues ventilation. If the tracheostomy tube becomes re-connected, the alarm auto-resets.

Airway Occlusion Alarm

If the area surrounding the tracheostomy tube becomes obstructed during ventilation in Speaking Mode (e.g., the tracheostomy cuff is inflated) so the flow rate through the patient's airway during exhalation is less than 5 L/min for the entire exhalation, a high urgency airway occlusion alarm will sound. The ventilator continues to ventilate and the exhalation valve closes during inhalation only.

The airway occlusion alarm will auto-reset when an exhalation occurs that does not meet the alarm condition. The airway occlusion alarm cannot be silenced by the alarm silence key.

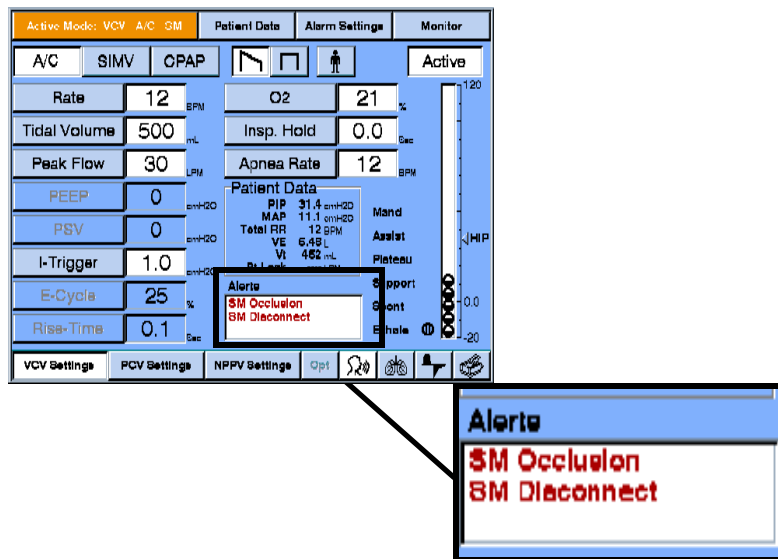

Figure 13-64: Speaking Mode Alerts: Disconnect and Airway Occlusion Alarms

Displayed Data

While in Speaking Mode, the ventilator switches all volumetric readings from exhaled to delivered readings. This means that all data displayed based on exhaled volumes will now be based on delivered volumes. Some data is not available in Speaking Mode, including data on Patient Leak (circled below in Figure 9).

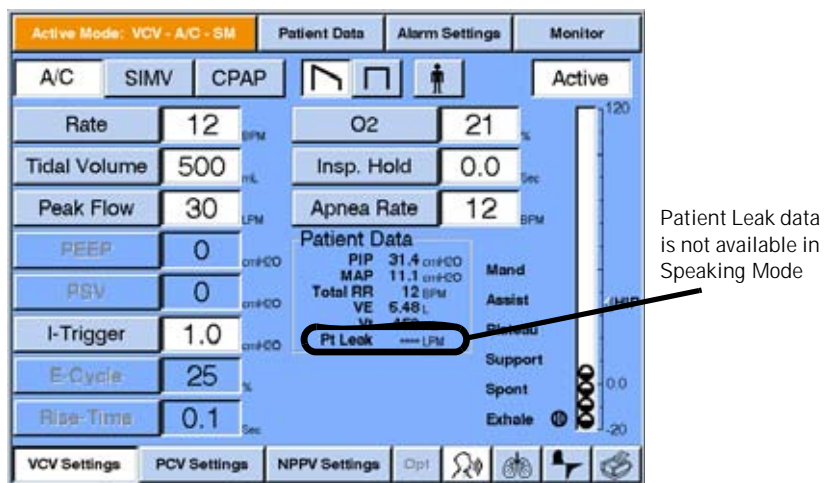

Figure 13-65: Active Mode: Displayed Data in the VCV Settings Screen

The following data in the Patient Data screen displays in delivered volumes (not exhaled volumes):

- Tidal Volume
- Spontaneous Minute Volume
- Total Minute Volume

The following data is not available in Speaking Mode. Dashed lines appear in the data box instead of a numeric value:

- Patient Leak
- F/Vt (Ratio of respiratory rate to tidal volume)

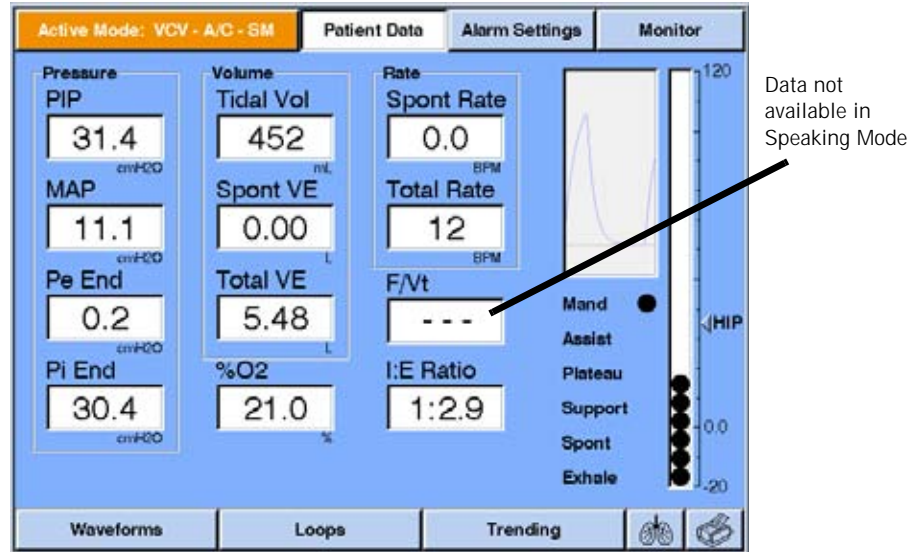

Figure 13-66: Active Mode: Patient Data Screen

Trended Data

NOTE: NICO data is not available when the Speaking Mode is active

NOTE: The time spent in Speaking Mode can be recorded as trended data. This requires the Trending Option be loaded and active on the ventilator.

To access the Trending screen:

1. Press the **Patient Data** button at the top of the settings screen (see Figure 13-66).
2. Press the **Trending** button at the bottom of the settings screen (see Figure 13-67).
3. Choose a **Parameter select** button (light blue button above each displayed data option) that shows the name of the currently displayed data option (see Figure 13-67).
4. Once the **Trended Data pop-up window** has displayed, click on one of the **Category Select** buttons at the top of the menu to view and select parameters for each option.

Speaking Mode Trended Data

To display trended data in **Speaking Mode**, press the **Speaking Mode Parameter select** button over the displayed data option (if displayed). Or press any **Parameter select** button to activate the **Trended Data pop-up window**. (Figure 13-67).

1. Press the **Settings** button.
2. Press the **Speaking Mode** button to show trended data options available in Speaking Mode (Figure 13-68).

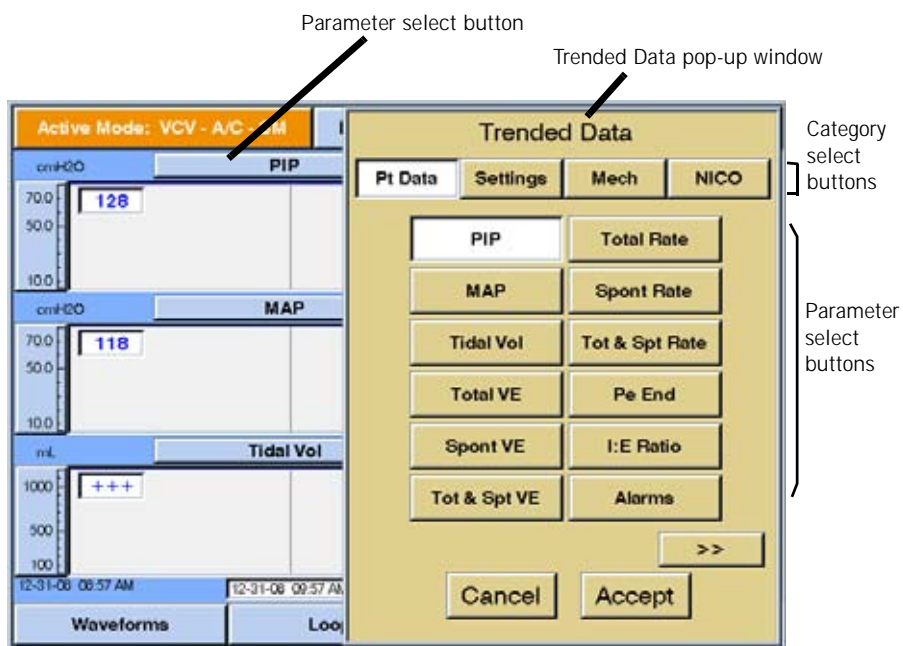

Figure 13-67: Selecting Speaking Mode on the Trended Data Screen

The trended data will appear as blocks of time shown as either ON or OFF.

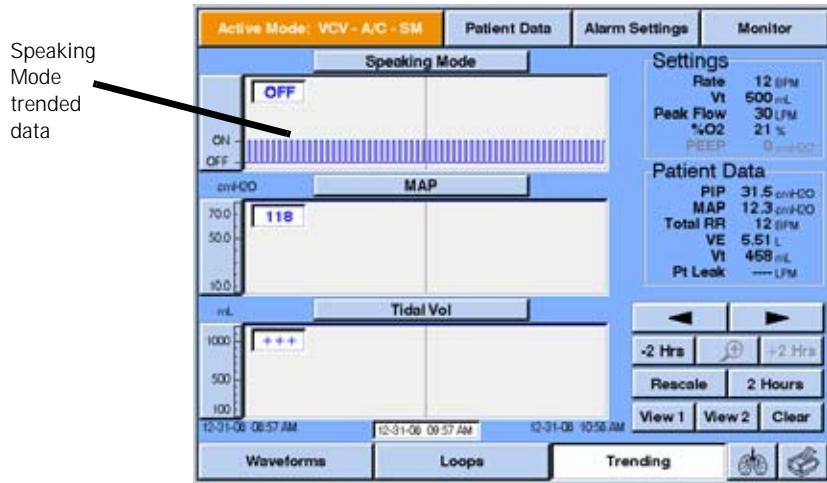

Figure 13-68: Speaking Mode Trended Data Screen

For more information regarding Trending, see the *Trending Option* instructions or contact Respirationics, Inc. Customer Service at the following numbers:

- USA and Canada: 1-800-345-6443 or 724-387-4000
- Europe, Africa, and the Middle East: +33-1-47-52-30-00
- Asia Pacific: +852-3194-2280

In North America:

Respirationics California, Inc.
 2271 Cosmos Court
 Carlsbad, California 92011
 Made in USA

Discontinue Speaking Mode

Removing a patient from Speaking Mode is very similar to starting a patient on Speaking Mode.

1. Press the **Speaking Mode** button.
2. The message box appears, *Turn Speaking Mode Off?*, reminding the user to:

Please be sure to inflate tracheostomy cuff

AFTER switching SM OFF,

Patent Data values and alarms will be based on exhaled volumes.

WARNING: Do not inflate the tracheostomy tube cuff until Speaking Mode has been turned off.

- Press **Yes** to turn Speaking Mode off.
- 3. Inflate the tracheostomy tube cuff (if **Yes** was pressed).
- Press **No** to remain in Speaking Mode.

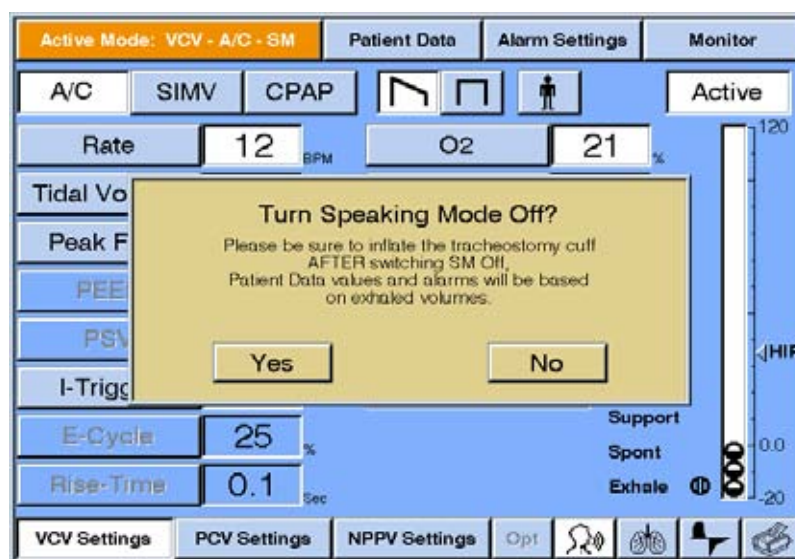

Figure 13-69: Turn Speaking Mode Off? Message Box

When discontinuing Speaking Mode, we recommend reviewing alarm and ventilator settings again. Continue to monitor patient's respiratory effort and clinical status.

(This page is intentionally blank.)

Auto-Trak Sensitivity™

Introduction

Auto-Trak Sensitivity is a feature designed to enhance patient comfort and ventilation effectiveness and reduce patient work of breathing. Auto-Trak automatically triggers and cycles breathing without the need for user-adjustment of I-Trigger (sensitivity) and E-Trigger (cycling) thresholds.

Auto-Trak is available in Volume Control Ventilation (VCV), Pressure Control Ventilation (PCV), and Noninvasive Positive Pressure Ventilation (NPPV).

Compatible Patient Interfaces

Respironics recommends the following patient interfaces for compatibility with the V200 Ventilator in NPPV. Refer to the usage instructions provided with each mask for detailed instructions.

- Respironics Image3™ Full Face Mask
- Respironics Spectrum™ Disposable Full Face Mask
- Respironics Total™ Face Mask
- Respironics Disposable Contour™ Deluxe Nasal Mask
- Respironics Disposable Small Child Nasal Mask
- Respironics Disposable Nasal Mask

The V200 Ventilator's built-in exhalation valve satisfies any Respironics mask requirement for an exhalation port in the patient circuit. Do not use an additional exhalation device (for example, Whisper Swivel®, Plateau™ Exhalation Valve, or equivalent).

If the mask you are using has an air entrainment valve, be sure to titrate the EPAP level such that the entrainment valve remains closed to room air. This will ensure that the oxygen mix and breath triggering remain unaffected.

WARNING: Titrate the EPAP level such that the masks air entrainment valve (if present) remains closed to room air. Always evaluate and monitor patient condition when adjusting EPAP or other settings.

How to Select Auto-Trak

1. Touch either the I-Trigger or E-Trigger button in the Settings screen (Figure 13-70).

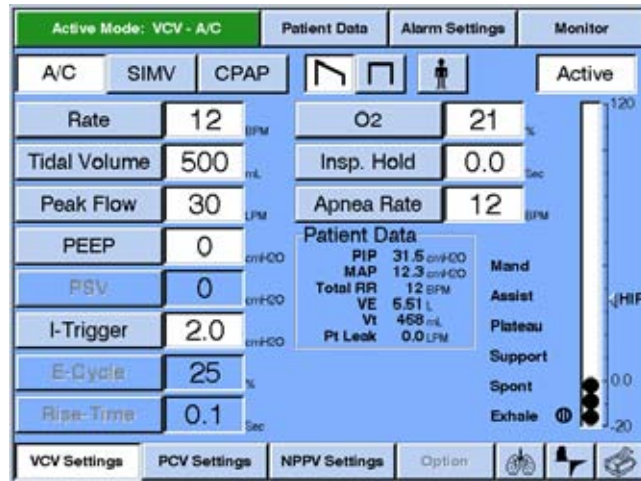

Figure 13-70: Settings Screen

2. When the I-Trigger or E-Trigger window appears, touch the Auto button (Figure 13-71 and Figure 13-72).

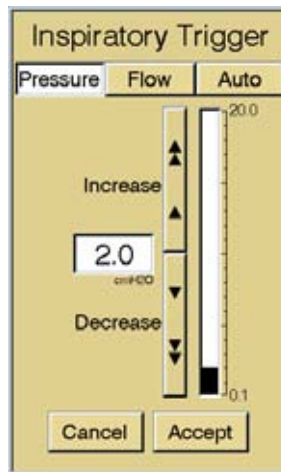

Figure 13-71: Sample Inspiratory Trigger Window with Auto-Trak Option Available (Pressure is not an available option for NPPV)

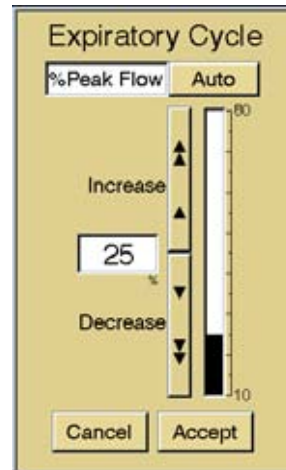

Figure 13-72: Sample Expiratory Trigger Window with Auto-Trak Option Available.

The Pressure or Flow values that previously appeared in the I-Trigger and E-Trigger windows are removed (Figure 13-73 and Figure 13-74).



Figure 13-73: Sample Inspiratory Trigger Window with Auto-Trak Option Selected (Pressure is not an available option for NPPV)



Figure 13-74: Sample Expiratory Trigger Window with Auto-Trak Option Selected

3. Touch the Accept button. The ventilator does not begin using Auto-Trak until you touch the Accept button. The Settings screen now displays Auto as the I-Trigger and E-Trigger settings (Figure 13-75).

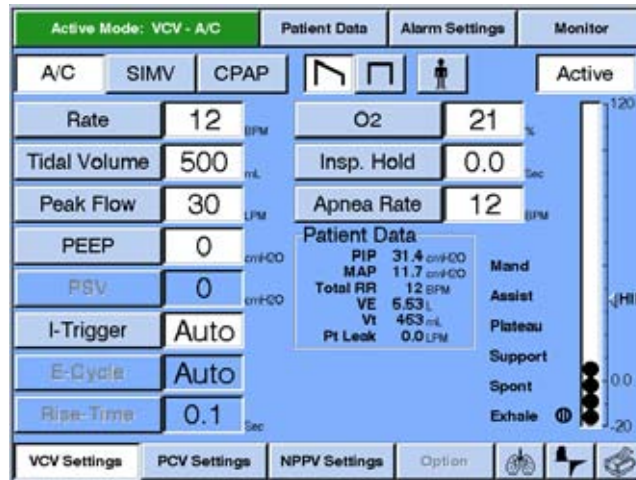

Figure 13-75: Settings Window with Auto-Trak Selected

Turning Auto-Trak Off

1. Touch either the I-Trigger or E-Trigger button in the Settings screen (Figure 13-70). The I- Trigger or E-Trigger window will appear as shown in Figure 13-73 or Figure 13-74.
2. Change the I-Trigger setting to Pressure or Flow, or change the E- Trigger setting to %Peak Flow. (When you change the I-Trigger setting to Pressure or Flow, the E- Trigger reverts to the most recently selected %Peak Flow value. Similarly, when you change the E-Trigger setting to %Peak Flow, the I-Trigger reverts to the most recently selected Pressure or Flow value.)
3. Touch the Accept button in the I-Trigger or E-Trigger window. The Settings screen will display the current I-Trigger and E-Trigger values as shown in Figure 13-70.

Triggering and Cycling with Auto-Trak

In order to determine triggering and cycling sensitivity thresholds for each breath, Auto-Trak applies multiple algorithms derived from flow, volume and pressure measurements throughout the breathing cycle.

Triggering

Auto-Trak monitors changes in pressure and flow patterns throughout exhalation, applies compensation for circuit leaks, and triggers an inspiration when the criterion for one of the triggering algorithms has been met. As a backup, Auto-Trak uses pressure triggering at a fixed level of 3 cm H₂O.

Cycling

Auto-Trak automatically cycles breathing based on the pressure and flow patterns at the end of inspiration and beginning of expiration. The threshold used to cycle each breath changes with the patients breathing pattern and lung dynamics.

Leak Detection and Compensation

Patient leaks at the mask interface are a critical factor and are significant in determining triggering and cycling thresholds. With noninvasive ventilation, failure to compensate for these leaks can impact the patients work of breathing.

Patient leak is the average leak rate during a breath and is estimated as the delivered volume minus exhaled volume divided by the total breath time. This average estimated leak value is displayed in LPM as Pt Leak in the Patient Data section of the Settings screen. Pt Leak is updated with each breath.

Bias flow through the patient circuit is adjusted according to the estimated leak and is quantified as follows:

Options and Accessories

- For adult patients: Bias flow = Pt Leak + 5 LPM.
- For pediatric patients: Bias flow = Pt Leak + 3 LPM.

Patient flow is estimated as the delivered flow (Bias flow during exhalation) minus the estimated Leak Flow, minus the measured expiratory flow (flow through the exhalation valve):

- Patient flow = Delivered flow - Leak flow measured expiratory flow

The estimated Leak Flow value in the above equation differs from the Patient Leak value defined earlier. Leak Flow is the estimated leak at a given moment in time and is dependent upon pressure (the higher the pressure, the higher the leak flow) and the physical characteristics of the leak itself. The Patient Leak value is the average Leak Flow over an entire breath.

When Auto-Trak is selected in NPPV mode, the estimated exhaled tidal volume includes compensation for the estimated leak volume lost during exhalation. Therefore, all other parameters that depend on exhaled tidal volume also include this compensation (for example, minute ventilation and rapid-shallow breathing index, F/Vt).

If the Graphics Option is enabled, waveforms and loops displayed in NPPV mode will show estimated flows and volumes that include compensation for the estimated leak.

Exhaled tidal volume is leak-compensated only in NPPV. Leaks that may occur during invasive ventilation are intentionally not compensated for, allowing them to be more easily detected.

Appendix A. RS-232 Communications Protocol

The ventilator will allow for the transmission of data from the ventilator via the RS-232 communications interface. The ventilator receives commands from the remote device and responds with fixed format records.

RS-232 Configuration

The RS-232 communications port will be configured in the following manner for all communications functions:

- Baud Rate 19,200
- Data Bits 8
- Parity None
- Stop Bits 1

Commands Transmitted to the Ventilator

Commands are transmitted as a series of four ASCII characters followed by a carriage return. Valid commands will be stored and response transmissions will be sent in the order the corresponding commands were received. Invalid commands will be returned in an error message (Table A-7: "Unrecognized Commands" on page A-24), in sequence with all other commands.

Transmission of Data from the Ventilator

Unless stated otherwise, all fields will be left justified and six (6) characters in length. A comma will separate each field. Each data transmission shall be terminated with a carriage return.

In the following subparagraphs, a space is designated as "◆". When data is unavailable, the output field shall contain "----◆◆" (i.e. four dash characters followed by two spaces).

Ventilator Report Command and Response (VRPT)

When the ventilator receives VRPT followed by a carriage return, it will respond by transmitting the information shown in Table A-1: "Ventilation Report". The ventilator responds to the VRPT command by returning a string with a variable length. Fields 2 through 4 define the length of the message. The last character transmitted is a stop code indicating the end of the message. The second field indicates the number of characters between the start and stop codes. The third field indicates the number of fields between the start and stop codes. The fourth field is the start code, 0x02. The last field in the string is the stop code, 0x03.

RS-232 Communications Protocol

Ventilation Report					
Description	Example	Resolution	Range	Units	Comments
Command Name	VRPT	N/A	N/A	N/A	
Number of characters between the start and stop codes	990	N/A	N/A	N/A	3 character field
Number of fields between the start and stop codes	134	N/A	N/A	N/A	3 character field
Start Code	0x02	N/A	N/A	N/A	ASCII Start Transmission Character (STX)
Time of request	13:45◆	N/A	N/A	N/A	24 hour clock, hh:mm◆
Date	FEB◆23◆1997◆	N/A	N/A	N/A	12 character field, MMM◆DD◆YYYY◆
Current Ventilation Type	VCV◆◆◆	N/A	VCV◆◆◆ PCV◆◆◆ NPPV◆◆	N/A	The ventilation type currently being used by the ventilator.
VCV Mode Setting	A/C◆◆◆	N/A	A/C◆◆◆ SIMV◆◆ CPAP◆◆	N/A	
VCV Waveform Setting	RAMP◆◆	N/A	RAMP◆◆ SQUARE	N/A	
VCV Patient Type	ADULT◆	N/A	ADULT◆ PED◆◆◆ NEO◆◆◆		
VCV Respiratory Rate Setting	12◆◆◆◆	1	1 - 80	BPM	
VCV Tidal Volume Setting	500◆◆◆	1	50 - 2500	mL	
VCV Peak Flow Setting	30◆◆◆◆	1	3 - 140	LPM	
VCV PEEP Setting	0◆◆◆◆◆	1	0 - 35	cmH ₂ O (hPa)	
VCV Pressure Support Setting	0◆◆◆◆◆	1	0 - 100	cmH ₂ O (hPa)	
VCV I-Trigger Type	PRESS◆	N/A	PRESS◆ FLOW◆◆ AUTO◆◆	N/A	
VCV Pressure I-Trigger Setting	2.0◆◆◆	0.1	0.1 - 20.0	cmH ₂ O (hPa)	
VCV Flow I-Trigger Setting	3.0◆◆◆	0.1	0.5 - 20.0	LPM	

Table A-1: Ventilation Report (Sheet 1 of 10)

RS-232 Communications Protocol

Ventilation Report (Continued)					
Description	Example	Resolution	Range	Units	Comments
VCV E-Cycle Type	%Flow◆	N/A	%FLOW◆ AUTO◆◆	N/A	
VCV %Flow Expiratory Cycle Setting	25◆◆◆◆	1	10 - 80	%	
VCV Rise Time	0.1◆◆◆	0.1	0.1 - 0.9	Sec	
VCV Oxygen Concentration Setting	21◆◆◆◆	1	21 - 100	%	
VCV Plateau Setting	0.0◆◆◆	0.1	0.0 - 2.0	Sec	
VCV Apnea Rate Setting	12◆◆◆◆	1	1 - 80	BPM	
VCV High Inspiratory Pressure Alarm Limit Setting	35◆◆◆◆	1	10 - 105	cmH ₂ O (hPa)	
VCV Low Inspiratory Pressure Alarm Limit Setting	3◆◆◆◆	1	3 - 105	cmH ₂ O (hPa)	
VCV Low PEEP Alarm Limit Setting	0◆◆◆◆	1	0 - 35	cmH ₂ O (hPa)	
VCV Low Mandatory Tidal Volume Alarm Limit Setting	0◆◆◆◆	1	0 - 2500	mL	
VCV Low Spontaneous Tidal Volume Alarm Limit Setting	0◆◆◆◆	1	0 - 2500	mL	
VCV High Respiratory Rate Alarm Limit Setting	150◆◆◆	1	0 - 150	BPM	
VCV Low Minute Volume Alarm Limit Setting	1.00◆◆	0.01 for 0.00 to 9.99 0.1 for 10.0 to 60.0	0.00 - 60.0	L	
VCV Apnea Interval Alarm Limit Setting	20◆◆◆◆	1	10 - 60	sec	
PCV Mode Setting	A/C◆◆◆	N/A	A/C◆◆◆ SIMV◆◆ CPAP◆◆	N/A	
PCV Patient Type	ADULT◆	N/A	ADULT◆ PED◆◆◆ NEO◆◆◆		
PCV Respiratory Rate Setting	12◆◆◆◆	1	1 - 150	BPM	
PCV Pressure Setting	20◆◆◆◆	1	5 - 100	cmH ₂ O (hPa)	

Table A-1: Ventilation Report (Sheet 2 of 10)

RS-232 Communications Protocol

Ventilation Report (Continued)					
Description	Example	Resolution	Range	Units	Comments
PCV Inspiratory Time Setting	1.00◆◆	0.01	0.1 - 9.9	sec	
PCV PEEP Setting	0◆◆◆◆◆	1	0 - 35	cmH ₂ O (hPa)	
PCV Pressure Support Setting	0◆◆◆◆◆	1	0 - 100	cmH ₂ O (hPa)	
PCV I-Trigger Type	PRESS◆	N/A	PRESS◆ FLOW◆◆ AUTO◆◆	N/A	
PCV Pressure I-Trigger Setting	2.0◆◆◆	0.1	0.1 - 20.0	cmH ₂ O (hPa)	
PCV Flow I-Trigger Setting	3.0◆◆◆	0.1	0.3 - 20.0	LPM	
PCV E-Cycle Type	%FLOW◆	N/A	%FLOW◆ AUTO◆◆	N/A	
PCV %Flow Expiratory Cycle Setting	25◆◆◆◆	1	10 - 80	%	
PCV Rise Time	0.1◆◆◆	0.1	0.1 - 0.9	sec	
PCV Oxygen Concentration Setting	21◆◆◆◆	1	21 - 100	%	
PCV Apnea Rate Setting	12◆◆◆◆	1	1 - 80	BPM	
PCV Apnea Interval Alarm Limit Setting	20◆◆◆◆	1	10 - 60	sec	
PCV High Inspiratory Pressure Alarm Limit Setting	35◆◆◆◆	1	10 - 105	cmH ₂ O (hPa)	
PCV Low Inspiratory Pressure Alarm Limit Setting	3◆◆◆◆◆	1	3 - 105	cmH ₂ O (hPa)	
PCV Low PEEP Alarm Limit Setting	0◆◆◆◆◆	1	0 - 35	cmH ₂ O (hPa)	
PCV Low Mandatory Tidal Volume Alarm Limit Setting	0◆◆◆◆◆	1	0 - 2500	mL	
PCV Low Spontaneous Tidal Volume Alarm Limit Setting	0◆◆◆◆◆	1	0 - 2500	mL	
PCV High Respiratory Rate Alarm Limit Setting	150◆◆◆	1	0 - 150	BPM	

Table A-1: Ventilation Report (Sheet 3 of 10)

RS-232 Communications Protocol

Ventilation Report (Continued)					
Description	Example	Resolution	Range	Units	Comments
PCV Low Minute Volume Alarm Limit Setting	1.00◆◆	0.01 for 0.00 to 9.99 0.1 for 10.0 to 60.0	0.00 - 60.0	L	
PCV High Minute Volume Alarm Limit Setting	60.0◆◆	0.01 for 0.00 to 9.99 0.1 for 10.0 to 60.0	0.00 - 60.0	L	
NPPV Mode Setting	SPONT/T	N/A	SPONT/T SPONT◆◆		
NPPV Patient Type	ADULT◆	N/A	ADULT◆ PED◆◆◆ NEO◆◆◆		
NPPV Respiratory Rate Setting	12◆◆◆◆	1	1 - 80	BPM	
NPPV EPAP Setting	5◆◆◆◆	1	2 - 25	cmH ₂ O (hPa)	
NPPV IPAP Setting	5◆◆◆◆	1	2 - 35	cmH ₂ O (hPa)	
NPPV Inspiratory Time Setting	1.0◆◆◆	0.1	0.1 - 9.9	sec	
NPPV Rise Time	0.1◆◆◆	0.1	0.1 - 0.9	sec	
NPPV I-Trigger Type	AUTO◆	N/A	FLOW◆◆ AUTO◆◆	N/A	
NPPV Flow I-Trigger Setting	3.0◆◆◆	0.1	0.5 - 20.0	LPM	
NPPV E-Cycle Type	AUTO◆◆	N/A	FLOW◆◆ AUTO◆◆	N/A	
NPPV %Flow Expiratory Cycle Setting	25◆◆◆◆	1	10 - 80	%	
NPPV Oxygen Concentration Setting	21◆◆◆◆	1	21 - 100	%	
NPPV Apnea Rate Setting	12◆◆◆◆	1	1 - 80	BPM	
NPPV Low Inspiratory Pressure Alarm Limit Setting	3◆◆◆◆	1	3 - 105	cmH ₂ O (hPa)	
NPPV Low EPAP Alarm Limit Setting	0◆◆◆◆	1	0 - 25	cmH ₂ O (hPa)	
NPPV Low Tidal Volume Alarm Limit Setting	0◆◆◆◆	1	0 - 2500	mL	

Table A-1: Ventilation Report (Sheet 4 of 10)

RS-232 Communications Protocol

Ventilation Report (Continued)					
Description	Example	Resolution	Range	Units	Comments
NPPV High Respiratory Rate Alarm Limit Setting	150◆◆◆	1	0 - 150	BPM	
NPPV Low Minute Volume Alarm Limit Setting	1.00◆◆	0.01 for 0.00 to 9.99 0.1 for 10.0 to 60.0	0.00 - 60.0	L	
NPPV Apnea Interval Alarm Limit Setting	20◆◆◆◆	1	10 - 60	sec	
NPPV High Leak Alarm Limit Setting	60◆◆◆◆	1	10 - 60	sec	
Measured Peak Inspiratory Pressure	24.1◆◆	0.1 for -20.0 to 99.9 1 for 100 to 130	-20.0 - 130	cmH ₂ O (hPa)	The PIP value from the Patient Data screen.
Measured Mean Airway Pressure	5.6◆◆◆	0.1 for -20.0 to 99.9 1 for 100 to 120	-20.0 - 120	cmH ₂ O (hPa)	The MAP value from the Patient Data screen.
Measured End Expiratory Pressure	2.0◆◆◆	0.1	-20.0-99.9	cmH ₂ O (hPa)	The End Exp. value from the Patient Data screen.
Measured End Inhalation Pressure	24.0◆◆	0.1 for -20.0 to 99.9 1 for 100 to 130	-20.0 - 130	cmH ₂ O (hPa)	The Plateau value from the Patient Data screen.
Measured Tidal Volume	468◆◆◆	1	0 - 2500	mL	The Tidal Volume value from the Patient Data screen.
Measured Spontaneous Minute Volume	0.00◆◆	0.01 for 0.00 to 9.99 0.1 for 10.0 to 60.0	0.00 - 60.0	L	The Spont VE value from the Patient Data screen.
Measured Minute Volume	5.83◆◆	0.01 for 0.00 to 9.99 0.1 for 10.0 to 60.0	0.00 - 60.0	L	The Total VE value from the Patient Data screen.
Measured Spontaneous Breath Rate	0.0◆◆◆	0.1 for 0.0 to 9.9 1 for 10 to 150	0.0 - 150	BPM	The Spont Rate value from the Patient Data screen.
Measured Total Breath Rate	12.0◆◆	0.1 for 0.0 to 9.9 1 for 10 to 150	0 - 150	BPM	The Total Rate value from the Patient Data screen.
Measured Rapid Shallow Breathing Index	5◆◆◆◆	1	0 - 500	BPM/L	The F/Vt value from the Patient Data screen.

Table A-1: Ventilation Report (Sheet 5 of 10)

RS-232 Communications Protocol

Ventilation Report (Continued)					
Description	Example	Resolution	Range	Units	Comments
Measured I:E Ratio	1:4.1◆	0.1 for 9.9:1 to 1:9.9 1 for 1:10 to 1:99	4.1:1-1:99	N/A	The I:E Ratio display from the Patient Data screen.
Measured Patient Leak	0.0◆◆◆	0.1 for 0.0 to 99.9 1 for 100 to 140	0.0 - 140	LPM	The Pt Leak display.
Measured Percent of Breaths Triggered by the Patient (NPPV Spont/T mode only; otherwise ◆◆◆◆◆◆)	56.2	0.1 for 0.0 to 99.9 1 for 100	0.0 - 100	%	The Pt Trigger display on the NPPV Monitor screen.
Monitored Oxygen Concentration	55.1◆◆	0.1 for 0.0 to 99.9 1 for 100	0.0 - 100	%	The % O2 display from the Patient Data Screen.
Ti/Ttot	0.23◆◆	0.01	0.00 - 1.00	N/A	The Ti/Ttot display from the Mechanics Patient Status Screen
Dynamic Resistance	5.43◆◆	0.01 for 0.00 to 9.99 0.1 for 10.0 to 99.9 1 for 100 to 400	0.00 - 400	cmH ₂ O /L/Sec	The Dynamic Resistance display from the Mechanics Patient Status Screen
Dynamic Compliance	19.2◆◆	0.01 for 0.00 to 9.99 0.1 for 10.0 to 99.9 1 for 100 to 350	0.00 - 350	mL/cmH ₂ O	The Dynamic Compliance display from the Mechanics Patient Status Screen
Peak Lung Flow	35.1◆◆	0.1 for -99.9 to 99.9 1 for -100 to -300 1 for 100 to 300	-300 - 300	LPM	The Peak L-Flow display from the Mechanics Patient Status Screen
Vital Capacity	450◆◆	1	0 - 9999	mL	Vital Capacity display from Vital Capacity Screen

Table A-1: Ventilation Report (Sheet 6 of 10)

RS-232 Communications Protocol

Ventilation Report (Continued)					
Description	Example	Resolution	Range	Units	Comments
Vital Capacity Time of Last Maneuver	11-14-01◆◆13:11	1 minute	01-01-70 0:00 to 01-19-38 3:14	N/A	Time of Last Maneuver display from the Vital Capacity Screen.15 character field, 24 hour clock: MM-DD-YYuuHH:MM
MIP	-54.1◆	0.1 for -99.9 to 99.9 1 for -100 and 100 to 200	-100 - 200	cmH ₂ O	MIP display from MIP/PO.1 display Screen
MIP Time of Last Maneuver	11-14-01◆◆13:11	1 minute	01-01-7 0 0:00 to 01-19-38 3:14	N/A	MIP Time of Last Maneuver display from MIP/PO.1 Screen.15 character field, 24 hour clock: MM-DD-YYuuHH:MM
PO.1	-2.3◆◆	0.1 for -99.9 to 99.9 1 for -100 and 100 to 200	-100 - 200	cmH ₂ O	PO.1 display from MIP/PO.1 display screen
PO.1 Time of Last Maneuver	11-14-01◆◆13:11	1 minute	01-01-70 0:00 to 01-1-38 3:14	N/A	PO.1 Time of Last Maneuver display from MIP/PO.1 Screen.15 character field, 24 hour clock: MM-DD-YYwwHH:MM
Static Resistance	5.43◆◆	0.01 for 0.00 to 9.99 0.1 for 10.0 to 99.9 1 for 100 to 400	0.00 - 400	cmH ₂ O /L/Sec	Static Resistance display from the Static C & R screen
Static Compliance	19.2◆◆	0.01 for 0.00 to 9.99 0.1 for 10.0 to 99.9 1 for 100 to 350	0.00 - 350	mL/ cmH ₂ O	Static Compliance display from the Static C & R Screen
Static C & R Time of Last Maneuver	11-14-01◆◆13:11	1 minute	01-01-70 0:00 to 01-19-38 3:14	N/A	Static C & R Time of Last Maneuver display from Static C & R Screen.15 character field, 24 hour clock: MM-DD-YYwwHH:MM

Table A-1: Ventilation Report (Sheet 7 of 10)

RS-232 Communications Protocol

Ventilation Report (Continued)					
Description	Example	Resolution	Range	Units	Comments
AutoPeep	1.2◆◆	0.1 for -9.9 to 9.9 1 for -10 to -20 1 for 10 to 120	-20 - 120	cmH ₂ O	AutoPeep display from the Mechanics Patient Status Screen
AutoPeep Time of Last Maneuver	11-14-01◆◆13:11	1 minute	01-01-70 0:00 to 01-19-38 3:14	N/A	AutoPeep Time of Last Maneuver display from Mechanics Patient Status Screen. 15 character field, 24 hour clock: MM-DD-YYwwHH:MM
Occlusion Alarm Status or SM Occlusion Alarm Status	NORMAL	N/A	NORMAL ALARM◆ RESET◆	N/A	
Safety Valve Status	NORMAL	N/A	NORMAL ALARM◆ RESET◆	N/A	
Low Internal Battery Alarm Status	NORMAL	N/A	NORMAL ALARM◆ RESET◆	N/A	
Nonvolatile Memory Failure—Using Default Settings	NORMAL	N/A	NORMAL ALARM◆ RESET◆	N/A	
Primary Alarm Failure	NORMAL	N/A	NORMAL ALARM◆ RESET◆	N/A	
High Inspiratory Pressure Alarm Status	NORMAL	N/A	NORMAL ALARM◆ RESET◆	N/A	
Apnea Alarm Status	NORMAL	N/A	NORMAL ALARM◆ RESET◆	N/A	
Low Inspiratory Pressure Alarm Status or Disconnect Alarm Status	NORMAL	N/A	NORMAL ALARM◆ RESET◆	N/A	
Air Source Fault Alarm Status	NORMAL	N/A	NORMAL ALARM◆ RESET◆	N/A	
O ₂ Valve Stuck Closed Alarm Status	NORMAL	N/A	NORMAL ALARM◆ RESET◆	N/A	

Table A-1: Ventilation Report (Sheet 8 of 10)

RS-232 Communications Protocol

Ventilation Report (Continued)					
Description	Example	Resolution	Range	Units	Comments
Exhalation Valve Stuck Open Alarm Status	NORMAL	N/A	NORMAL ALARM◆ RESET◆	N/A	
Low O ₂ Supply Alarm Status	NORMAL	N/A	NORMAL ALARM◆ RESET◆	N/A	Low supply pressure
Low O ₂ Alarm Status	NORMAL	N/A	NORMAL ALARM◆ RESET◆	N/A	Low O ₂ concentration
Low Minute Volume Alarm Status	NORMAL	N/A	NORMAL ALARM◆ RESET◆	N/A	
Low Mandatory Tidal Volume Alarm Status	NORMAL	N/A	NORMAL ALARM◆ RESET◆	N/A	
High Minute Volume Alarm Status	NORMAL	N/A	NORMAL ALARM◆ RESET◆	N/A	
Low Tidal Volume Alarm Status	NORMAL	N/A	NORMAL ALARM◆ RESET◆	N/A	
Low Spontaneous Tidal Volume Alarm Status	NORMAL	N/A	NORMAL ALARM◆ RESET◆	N/A	
I-Time Too Long Alarm Status	NORMAL	N/A	NORMAL ALARM◆ RESET◆	N/A	
High Respiratory Rate Alarm Status	NORMAL	N/A	NORMAL ALARM◆ RESET◆	N/A	
High O ₂ Alarm Status	NORMAL	N/A	NORMAL ALARM◆ RESET◆	N/A	
High Enclosure Temperature Alarm Status	NORMAL	N/A	NORMAL ALARM◆ RESET◆	N/A	
High Internal Oxygen Concentration Alarm Status	NORMAL	N/A	NORMAL ALARM◆ RESET◆	N/A	
Low PEEP Alarm Status	NORMAL	N/A	NORMAL ALARM◆ RESET◆	N/A	

Table A-1: Ventilation Report (Sheet 9 of 10)

RS-232 Communications Protocol

Ventilation Report (Continued)					
Description	Example	Resolution	Range	Units	Comments
Low EPAP Alarm Status	NORMAL	N/A	NORMAL ALARM◆ RESET◆	N/A	
High Leak Alarm Status	NORMAL	N/A	NORMAL ALARM◆ RESET◆	N/A	
100% O ₂ Function Status	OFF◆◆◆	N/A	ON◆◆◆◆ OFF◆◆◆	N/A	Status of the 100% O ₂ LED on the front panel
Alarm Silence Status	OFF◆◆◆	N/A	ON◆◆◆◆ OFF◆◆◆	N/A	Status of the Alarm Silence LED on the front panel
Screen Lock Status	OFF◆◆◆	N/A	ON◆◆◆◆ OFF◆◆◆	N/A	Status of the Screen Lock LED on the front panel
Tube Type	ET◆◆◆◆	N/A	ET◆◆◆◆ TT◆◆◆◆ NONE◆◆	N/A	Tube type as selected in Respiratory Mechanics Screens (Not used)
Tube Size	7.0◆◆◆	0.1 for 3.5 to 9.9 1 for 10	3.5 - 10	mm	Tube size as selected in Respiratory Mechanics Screens (Not used)
VCV High Minute Volume Alarm Limit Setting	60.0◆◆	0.01 for 0.00 to 9.99 0.1 for 10.0 to 60.0	0.00 - 60.0	L	
Static C & R Plateau End Pressure	8.2◆◆◆	0.1 for -20 to 99.9 1 for 100 to 130	-20.0 - 130	cmH ₂ O	P _{plat} display from Static C & R Screen
Stop Code	0x03	N/A	N/A	N/A	ASCII End Transmission Character (ETX)

Table A-1: Ventilation Report (Sheet 10 of 10)

Volume Control Ventilation Settings Report (VCVS)

When the ventilator receives VCVS followed by a carriage return, it will respond by transmitting the information shown in Table A-2: "Volume Control Ventilation Settings Report". The ventilator responds to the VCVS command by returning a string with a variable length. Fields 2 through 4 define the length of the message. The last character transmitted is a stop code indicating the end of the message. The second field indicates the number of characters between the start and stop codes. The third field indicates the number of

RS-232 Communications Protocol

fields between the start and stop codes. The fourth field is the start code, 0x02. The last field in the string is the stop code, 0x03.

Volume Control Ventilation Settings Report					
Description	Example	Resolution	Range	Units	Comments
Command Name	VCVS	N/A	N/A	N/A	
Number of characters between the start and stop codes	209	N/A	N/A	N/A	3 character field
Number of fields between the start and stop codes	29	N/A	N/A	N/A	2 character field
Start Code	0x02	N/A	N/A	N/A	ASCII Start Transmission Character (STX)
Time of request	13:45◆	N/A	N/A	N/A	24 hour clock, hh:mm◆
Date	FEB◆23◆1997◆	N/A	N/A	N/A	12 character field, MMM◆DD◆YYYY◆
Current Ventilation Type	VCV◆◆◆◆	N/A	VCV◆◆◆◆ PCV◆◆◆◆ NPPV◆◆	N/A	The ventilation type currently being used by the ventilation.
VCV Mode Setting	A/C◆◆◆◆	N/A	A/C◆◆◆◆ SIMV◆◆ CPAP◆◆	N/A	
VCV Waveform Setting	RAMP◆◆	N/A	RAMP◆◆ SQUARE	N/A	
VCV Patient Type	ADULT◆	N/A	ADULT◆ PED◆◆◆◆ NEO◆◆◆◆		
VCV Respiratory Rate Setting	12◆◆◆◆	1	1 - 80	BPM	
VCV Tidal Volume Setting	500◆◆◆◆	1	50 - 2500	mL	
VCV Peak Flow Setting	30◆◆◆◆	1	3 - 140	LPM	
VCV PEEP Setting	0◆◆◆◆◆	1	0 - 35	cmH ₂ O (hPa)	
VCV Pressure Support Setting	0◆◆◆◆◆	1	0 - 100	cmH ₂ O (hPa)	
VCV I-Trigger Type	PRESS◆	N/A	PRESS◆ FLOW◆◆ AUTO◆◆	N/A	
VCV Pressure I-Trigger Setting	2.0◆◆◆◆	0.1	0.1 - 20.0	cmH ₂ O (hPa)	

Table A-2: Volume Control Ventilation Settings Report (Sheet 1 of 2)

RS-232 Communications Protocol

Volume Control Ventilation Settings Report (Continued)					
Description	Example	Resolution	Range	Units	Comments
VCV Flow I-Trigger Setting	3.0◆◆◆	0.1	0.5 - 20.0	LPM	
VCV E-Cycle Type	%Flow◆	N/A	%FLOW◆ AUTO◆◆	N/A	
VCV %Flow Expiratory Cycle Setting	25◆◆◆◆	1	10 - 80	%	
VCV Rise Time	0.1◆◆◆	0.1	0.1 - 0.9	Sec	
VCV Oxygen Concentration Setting	21◆◆◆◆	1	21 - 100	%	
VCV Plateau Setting	0.0◆◆◆	0.1	0.0 - 2.0	Sec	
VCV Apnea Rate Setting	12◆◆◆◆	1	1 - 80	BPM	
VCV High Inspiratory Pressure Alarm Limit Setting	35◆◆◆◆	1	10 - 105	cmH ₂ O (hPa)	
VCV Low Inspiratory Pressure Alarm Limit Setting	3◆◆◆◆◆	1	3 - 105	cmH ₂ O (hPa)	
VCV Low PEEP Alarm Limit Setting	0◆◆◆◆◆	1	0 - 35	cmH ₂ O (hPa)	
VCV Low Mandatory Tidal Volume Alarm Limit Setting	0◆◆◆◆◆	1	0 - 2500	mL	
VCV Low Spontaneous Tidal Volume Alarm Limit Setting	0◆◆◆◆◆	1	0 - 2500	mL	
VCV High Respiratory Rate Alarm Limit Setting	150◆◆◆	1	0 - 150	BPM	
VCV Low Minute Volume Alarm Limit Setting	1.00◆◆◆	0.01 for 0.00 to 9.99 0.1 for 10.0 to 60.0	0.00 - 60.0	L	
VCV Apnea Interval Alarm Limit Setting	20◆◆◆◆	1	10 - 60	sec	
VCV High Minute Volume Alarm Limit Setting	60.0◆◆	0.01 for 0.00 to 9.99 0.1 for 10.0 to 60.0	0.00 - 60.0	L	
Stop Code	0x03	N/A	N/A	N/A	ASCII End Transmission Character (ETX)

Table A-2: Volume Control Ventilation Settings Report (Sheet 2 of 2)

Pressure Control Ventilation Settings Report (PCVS)

When the ventilator receives PCVS followed by a carriage return, it will respond by transmitting the information shown in Table A-3: "Pressure Control Ventilation Settings Report". The ventilator responds to the PCVS command by returning a string with a variable length. Fields 2 through 4 define the length of the message. The last character transmitted is a stop code indicating the end of the message. The second field indicates the number of characters between the start and stop codes. The third field indicates the number of fields between the start and stop codes. The fourth field is the start code, 0x02. The last field in the string is the stop code, 0x03.

Pressure Control Ventilation Settings Report					
Description	Example	Resolution	Range	Units	Comments
Command Name	PCVS	N/A	N/A	N/A	
Number of characters between the start and stop codes	195	N/A	N/A	N/A	3 character field
Number of fields between the start and stop codes	27	N/A	N/A	N/A	2 character field
Start Code	0x02	N/A	N/A	N/A	ASCII Start Transmission Character (STX)
Time of request	13:45◆	N/A	N/A	N/A	24 hour clock, hh:mm◆
Date	FEB◆23◆1997◆	N/A	N/A	N/A	12 character field, MMM◆DD◆YYYY◆
Current Ventilation Type	VCV◆◆◆	N/A	VCV◆◆◆ PCV◆◆◆ NPPV◆◆	N/A	The ventilation type currently being used by the ventilator.
PCV Mode Setting	A/C◆◆◆	N/A	A/C◆◆◆ SIMV◆◆ CPAP◆◆	N/A	
PCV Patient Type	ADULT◆	N/A	ADULT◆ PED◆◆◆ NEO◆◆◆		
PCV Respiratory Rate Setting	12◆◆◆◆	1	1 - 150	BPM	
PCV Pressure Setting	20◆◆◆◆	1	5 - 100	cmH ₂ O (hPa)	
PCV Inspiratory Time Setting	1.00◆◆	0.01	0.1 - 9.9	sec	
PCV PEEP Setting	0◆◆◆◆	1	0 - 35	cmH ₂ O (hPa)	
PCV Pressure Support Setting	0◆◆◆◆	1	0 - 100	cmH ₂ O (hPa)	

Table A-3: Pressure Control Ventilation Settings Report (Sheet 1 of 3)

RS-232 Communications Protocol

Pressure Control Ventilation Settings Report (Continued)					
Description	Example	Resolution	Range	Units	Comments
PCV I-Trigger Type	PRESS◆	N/A	PRESS◆ FLOW◆◆ AUTO◆◆	N/A	
PCV Pressure I-Trigger Setting	2.0◆◆◆	0.1	0.1 - 20.0	cmH ₂ O (hPa)	
PCV Flow I-Trigger Setting	3.0◆◆◆	0.1	0.3 - 20.0	LPM	
PCV E-Cycle Type	%FLOW◆	N/A	%FLOW◆ AUTO◆◆	N/A	
PCV %Flow Expiratory Cycle Setting	25◆◆◆◆	1	10 - 80	%	
PCV Rise Time	0.1◆◆◆	0.1	0.1 - 0.9	sec	
PCV Oxygen Concentration Setting	21◆◆◆◆	1	21 - 100	%	
PCV Apnea Rate Setting	12◆◆◆◆	1	1 - 80	BPM	
PCV Apnea Interval Alarm Limit Setting	20◆◆◆◆	1	10 - 60	sec	
PCV High Inspiratory Pressure Alarm Limit Setting	35◆◆◆◆	1	10 - 105	cmH ₂ O (hPa)	
PCV Low Inspiratory Pressure Alarm Limit Setting	3◆◆◆◆◆	1	3 - 105	cmH ₂ O (hPa)	
PCV Low PEEP Alarm Limit Setting	0◆◆◆◆◆	1	0 - 35	cmH ₂ O (hPa)	
PCV Low Mandatory Tidal Volume Alarm Limit Setting	0◆◆◆◆◆	1	0 - 2500	mL	
PCV Low Spontaneous Tidal Volume Alarm Limit Setting	0◆◆◆◆◆	1	0 - 2500	mL	
PCV High Respiratory Rate Alarm Limit Setting	150◆◆◆	1	0 - 150	BPM	
PCV Low Minute Volume Alarm Limit Setting	1.00◆◆	0.01 for 0.00 to 9.99 0.1 for 10.0 to 60.0	0.00 - 60.0	L	

Table A-3: Pressure Control Ventilation Settings Report (Sheet 2 of 3)

RS-232 Communications Protocol

Pressure Control Ventilation Settings Report (Continued)					
Description	Example	Resolution	Range	Units	Comments
PCV High Minute Volume Alarm Limit Setting	60.0◆◆	0.01 for 0.00 to 9.99 0.1 for 10.0 to 60.0	0.00 - 60.0	L	
Stop Code	0x03	N/A	N/A	N/A	ASCII End Transmission Character (ETX)

Table A-3: Pressure Control Ventilation Settings Report (Sheet 3 of 3)

Non-Invasive Positive Pressure Ventilation Settings Report (NPVS)

When the ventilator receives NPVS followed by a carriage return, it will respond by transmitting the information shown in Table A-4: "Non-Invasive Positive Pressure Ventilation Settings Report". The ventilator responds to the NPVS command by returning a string with a variable length. Fields 2 through 4 define the length of the message. The last character transmitted is a stop code indicating the end of the message. The second field indicates the number of characters between the start and stop codes. The third field indicates the number of fields between the start and stop codes. The fourth field is the start code, 0x02. The last field in the string is the stop code, 0x03.

Non-Invasive Positive Pressure Ventilation Settings Report					
Description	Example	Resolution	Range	Units	Comments
Command Name	NPVS	N/A	N/A	N/A	
Number of characters between the start and stop codes	168	N/A	N/A	N/A	3 character field
Number of fields between the start and stop codes	23	N/A	N/A	N/A	2 character field
Start Code	0x02	N/A	N/A	N/A	ASCII Start Transmission Character (STX)
Time of request	13:45◆	N/A	N/A	N/A	24 hour clock, hh:mm◆
Date	FEB◆23◆1997◆	N/A	N/A	N/A	12 character field, MMM◆DD◆YYYY◆
Current Ventilation Type	VCV◆◆◆	N/A	VCV◆◆◆ PCV◆◆◆ NPPV◆◆	N/A	The ventilation type currently being used by the ventilator.

Table A-4: Non-Invasive Positive Pressure Ventilation Settings Report (Sheet 1 of 3)

RS-232 Communications Protocol

Non-Invasive Positive Pressure Ventilation Settings Report (Continued)					
Description	Example	Resolution	Range	Units	Comments
NPPV Mode Setting	SPONT/T	N/A	SPONT/T SPONT◆◆		
NPPV Patient Type	ADULT◆	N/A	ADULT◆ PED◆◆◆ NEO◆◆◆		
NPPV Respiratory Rate Setting	12◆◆◆◆	1	1 - 80	BPM	
NPPV EPAP Setting	5◆◆◆◆◆	1	2 - 25	cmH ₂ O (hPa)	
NPPV IPAP Setting	5◆◆◆◆◆	1	2 - 35	cmH ₂ O (hPa)	
NPPV Inspiratory Time Setting	1.0◆◆◆◆	0.1	0.1 - 9.9	sec	
NPPV Rise Time	0.1◆◆◆◆	0.1	0.1 - 0.9	sec	
NPPV I-Trigger Type	FLOW◆◆	N/A	FLOW◆◆ AUTO◆◆	N/A	
NPPV Flow I-Trigger Setting	3.0◆◆◆◆	0.1	0.5 - 20.0	LPM	
NPPV E-Cycle Type	%FLOW◆	N/A	%FLOW◆ AUTO◆◆	N/A	
NPPV %Flow Expiratory Cycle Setting	25◆◆◆◆◆	1	10 - 80	%	
NPPV Oxygen Concentration Setting	21◆◆◆◆◆	1	21 - 100	%	
NPPV Apnea Rate Setting	12◆◆◆◆◆	1	1 - 80	BPM	
NPPV Low Inspiratory Pressure Alarm Limit Setting	3◆◆◆◆◆	1	3 - 105	cmH ₂ O (hPa)	
NPPV Low EPAP Alarm Limit Setting	0◆◆◆◆◆	1	0 - 25	cmH ₂ O (hPa)	
NPPV Low Tidal Volume Alarm Limit Setting	0◆◆◆◆◆	1	0 - 2500	mL	
NPPV High Respiratory Rate Alarm Limit Setting	150◆◆◆◆	1	0 - 150	BPM	
NPPV Low Minute Volume Alarm Limit Setting	1.00◆◆◆	0.01 for 0.00 to 9.99 0.1 for 10.0 to 60.0	0.00 - 60.0	L	
NPPV Apnea Interval Alarm Limit Setting	20◆◆◆◆◆	1	10 - 60	sec	

Table A-4: Non-Invasive Positive Pressure Ventilation Settings Report (Sheet 2 of 3)

RS-232 Communications Protocol

Non-Invasive Positive Pressure Ventilation Settings Report (Continued)					
Description	Example	Resolution	Range	Units	Comments
NPPV High Leak Alarm Limit	60◆◆◆◆	1	1 - 60	LPM	
Stop Code	0x03	N/A	N/A	N/A	ASCII End Transmission Character (ETX)

Table A-4: Non-Invasive Positive Pressure Ventilation Settings Report (Sheet 3 of 3)

Patient Data Report (PTDT)

When the ventilator receives PTDT followed by a carriage return, it will respond by transmitting the information shown in Table A-5: "Patient Data Report". The ventilator responds to the PTDT command by returning a string with a variable length. Fields 2 through 4 define the length of the message. The last character transmitted is a stop code indicating the end of the message. The second field indicates the number of characters between the start and stop codes. The third field indicates the number of fields between the start and stop codes. The fourth field is the start code, 0x02. The last field in the string is the stop code, 0x03.

Patient Data Report					
Description	Example	Resolution	Range	Units	Comments
Command Name	PTDT	N/A	N/A	N/A	
Number of characters between the start and stop codes	275	N/A	N/A	N/A	3 character field
Number of fields between the start and stop codes	32	N/A	N/A	N/A	2 character field
Start Code	0x02	N/A	N/A	N/A	ASCII Start Transmission Character (STX)
Time of request	13:45◆	N/A	N/A	N/A	24 hour clock, hh:mm◆
Date	FEB◆23◆1997◆	N/A	N/A	N/A	12 character field, MMM◆DD◆YYYY◆
Measured Peak Inspiratory Pressure	24.1◆◆	0.1 for -20.0 to 99.9 1 for 100 to 130	-20.0 - 130	cmH ₂ O (hPa)	The PIP value from the Patient Data screen.
Measured Mean Airway Pressure	5.6◆◆◆	0.1 for -20.0 to 99.9 1 for 100 to 120	-20.0 - 120	cmH ₂ O (hPa)	The MAP value from the Patient Data screen.

Table A-5: Patient Data Report (Sheet 1 of 4)

RS-232 Communications Protocol

Patient Data Report (Continued)					
Description	Example	Resolution	Range	Units	Comments
Measured End Expiratory Pressure Data	2.0◆◆◆	0.1	-20.0-99.9	cmH ₂ O (hPa)	The End Exp. value from the Patient Data screen.
Measured End Inhalation Pressure	24.0◆◆	0.1 for -20.0 to 99.9 1 for 100 to 130	-20.0 - 130	cmH ₂ O (hPa)	The Plateau value from the Patient Data screen.
Measured Tidal Volume	468◆◆◆	1	0 - 2500	mL	The Tidal Volume value from the Patient Data screen.
Measured Spontaneous Minute Volume	0.00◆◆	0.01 for 0.00 to 9.99 0.1 for 10.0 to 60.0	0.00 - 60.0	L	The Spont VE value from the Patient Data screen.
Measured Minute Volume	5.83◆◆	0.01 for 0.00 to 9.99 0.1 for 10.0 to 60.0	0.00 - 60.0	L	The Total VE value from the Patient Data screen.
Measured Spontaneous Breath Rate	0.0◆◆◆	0.1 for 0.0 to 9.9 1 for 10 to 150	0.0 - 150	BPM	The Spont Rate value from the Patient Data screen.
Measured Total Breath Rate	12.0◆◆	0.1 for 0.0 to 9.9 1 for 10 to 150	0 - 150	BPM	The Total Rate value from the Patient Data screen.
Measured Rapid Shallow Breathing Index	5◆◆◆◆	1	0 - 500	BPM/L	The F/Vt value from the Patient Data screen.
Measured I:E Ratio	1:4.1◆	0.1 for 9.9:1 to 1:9.9 1 for 1:10 to 1:99	4.1:1-1:99	N/A	The I:E Ratio display from the Patient Data screen.
Measured Patient Leak	0.0◆◆◆	0.1 for 0.0 to 99.9 1 for 100 to 140	0.0 - 140	LPM	The Pt Leak display.
Measured Percent of Breaths Triggered by the Patient (NPPV Spont/T mode only; otherwise ◆◆◆◆◆)	56.2◆◆	0.1 for 0.0 to 99.9 1 for 100	0.0 - 100	%	The Pt Trigger display on the NPPV Monitor screen.
Monitored Oxygen Concentration	55.1◆◆	0.1 for 0.0 to 99.91 for 100	0.0 - 100	%	The % O ₂ display from the Patient Data Screen.
Ti/Ttot	0.23◆◆	0.01	0.00 - 1.00	N/A	The Ti/Ttot display from the Mechanics Patient Status Screen

Table A-5: Patient Data Report (Sheet 2 of 4)

RS-232 Communications Protocol

Patient Data Report (Continued)					
Description	Example	Resolution	Range	Units	Comments
Dynamic Resistance	5.43◆◆	0.01 for 0.00 to 9.990.1 for 10.0 to 99.91 for 100 to 400	0.00 - 400	cmH2 O/L/ Sec	The Dynamic Resistance display from the Mechanics Patient Status Screen
Dynamic Compliance	19.2◆◆	0.01 for 0.00 to 9.990.1 for 10.0 to 99.91 for 100 to 350	0.00 - 350	mL/cm H2O	The Dynamic Compliance display from the Mechanics Patient Status Screen
Peak Lung Flow	35.1◆◆	0.1 for -99.9 to 99.91 for -100 to -3001 for 100 to 300	-300 - 300	LPM	The Peak L-Flow display from the Mechanics Patient Status Screen
Vital Capacity	468◆◆	1	0 - 9999	mL	Vital Capacity display from Vital Capacity Screen
Vital Capacity Time of Last Maneuver	11-14-01◆◆13:11	1 minute	01-01-70 0:00 to 01-19-38 3:14	N/A	Time of Last Maneuver display from the Vital Capacity Screen.15 character field, 24 hour clock: MM-DD-YYuuHH:MM
MIP	-54.1◆	0.1 for -99.9 to 99.91 for -100 and 100 to 200	-100 - 200	cm H2O	MIP display from MIP/PO.1 display Screen
MIP Time of Last Maneuver	11-14-01◆◆13:11	1 minute	01-01-7 0 0:00 to 01-19-38 3:14	N/A	MIP Time of Last Maneuver display from MIP/PO.1 Screen15 character field, 24 hour clock: MM-DD-YYuuHH:MM
PO.1	-2.3◆◆	0.1for -99.9 to 99.91 for -100 and 100 to 200	-100 - 200	cm H2O	PO.1 display from MIP/PO.1 display screen
PO.1 Time of Last Maneuver	11-14-01◆◆13:11	1 minute	01-01-70 0:00 to 01-1-/38 3:14	N/A	PO.1 Time of Last Maneuver display from MIP/PO.1 Screen.15 character field, 24 hour clock: MM-DD-YYwwHH:MM
Static Resistance	5.43◆◆	0,01 for 0.00 to 9.990.1 for 10.0 to 99.91 for 100 to 400	0.00 - 400	cmH2 O/L/ Sec	Static Resistance display from the Static C & R screen

Table A-5: Patient Data Report (Sheet 3 of 4)

RS-232 Communications Protocol

Patient Data Report (Continued)					
Description	Example	Resolution	Range	Units	Comments
Static Compliance	19.2◆◆	0.01 for 0.00 to 9.99 0.1 for 10.0 to 99.91 1 for 100 to 350	0.00 - 350	mL/ cmH2 0	Static Compliance display from the Static C & R Screen
Static C & R Time of Last Maneuver	11-14-01◆◆13:11	1 minute	01-01-70 0:00 to 01-19-38 3:14	N/A	Static C & R Time of Last Maneuver display from Static C & R Screen. 15 character field, 24 hour clock: MM-DD-YYwwHH:MM
AutoPeep	1.2◆◆	0.1 for -9.9 to 9.91 for -10 to -201 10 to 120	-20 - 120	cmH2 0	AutoPeep display from the Mechanics Patient Status Screen
AutoPeep Time of Last Maneuver	11-14-01◆◆13:11	1 minute	01-01-70 0:00 to 01-19-38 3:14	N/A	AutoPeep Time of Last Maneuver display from Mechanics Patient Status Screen. 15 character field, 24 hour clock: MM-DD-YYwwHH:MM
Static C & R Plateau End Pressure	8.2◆◆◆	0.2 for -20 to 99.9 1 for 100 to 130	-20.0 - 130	cmH2O	P _{plat} display from Static C & R Screen
Stop Code	0x03	N/A	N/A	N/A	ASCII End Transmission Character (ETX)

Table A-5: Patient Data Report (Sheet 4 of 4)

Alarm Status Report (ALRM)

When the ventilator receives ALRM followed by a carriage return, it will respond by transmitting the information shown in Table A-6: "Alarm Status Report". The ventilator responds to the ALRM command by returning a string with a variable length. Fields 2 through 4 define the length of the message. The last character transmitted is a stop code indicating the end of the message. The second field indicates the number of characters between the start and stop codes. The third field indicates the number of fields between the start and stop codes. The fourth field is the start code, 0x02. The last field in the string is the stop code, 0x03.

RS-232 Communications Protocol

Alarm Status Report			
Description	Example	Range	Comments
Command Name	ALRM	N/A	
Number of characters between the start and stop codes	202	N/A	3 character field
Number of fields between the start and stop codes	28	N/A	2 character field
Start Code	0x02	N/A	ASCII Start Transmission Character (STX)
Time of request	13:45◆	N/A	24 hour clock, hh:mm◆
Date	FEB◆23◆1997◆	N/A	12 character field, MMM◆DD◆YYYY◆
Occlusion Alarm Status or SM Occlusion Status	NORMAL	NORMAL ALARM◆ RESET◆	
Safety Valve Status	NORMAL	NORMAL ALARM◆ RESET◆	
Low Internal Battery Alarm Status	NORMAL	NORMAL ALARM◆ RESET◆	
Nonvolatile Memory Failure—Using Default Settings	NORMAL	NORMAL ALARM◆ RESET◆	
Primary Alarm Failure	NORMAL	NORMAL ALARM◆ RESET◆	
High Inspiratory Pressure Alarm Status	NORMAL	NORMAL ALARM◆ RESET◆	
Apnea Alarm Status	NORMAL	NORMAL ALARM◆ RESET◆	
Low Inspiratory Pressure Alarm Status or Disconnect Alarm Status	NORMAL	NORMAL ALARM◆ RESET◆	
Air Source Fault Alarm Status	NORMAL	NORMAL ALARM◆ RESET◆	
O ₂ Valve Stuck Closed Alarm Status	NORMAL	NORMAL ALARM◆ RESET◆	

Table A-6: Alarm Status Report (Sheet 1 of 3)

RS-232 Communications Protocol

Alarm Status Report (Continued)			
Description	Example	Range	Comments
Exhalation Valve Stuck Open Alarm Status	NORMAL	NORMAL ALARM◆ RESET◆	
Low O ₂ Supply Alarm Status	NORMAL	NORMAL ALARM◆ RESET◆	Low supply pressure
Low O ₂ Alarm Status	NORMAL	NORMAL ALARM◆ RESET◆	Low O ₂ concentration
Low Minute Volume Alarm Status	NORMAL	NORMAL ALARM◆ RESET◆	
Low Mandatory Tidal Volume Alarm Status	NORMAL	NORMAL ALARM◆ RESET◆	
High Minute Volume Alarm Status	NORMAL	NORMAL ALARM◆ RESET◆	
Low Tidal Volume Alarm Status	NORMAL	NORMAL ALARM◆ RESET◆	
Low Spontaneous Tidal Volume Alarm Status	NORMAL	NORMAL ALARM◆ RESET◆	
I-Time Too Long Alarm Status	NORMAL	NORMAL ALARM◆ RESET◆	
High Respiratory Rate Alarm Status	NORMAL	NORMAL ALARM◆ RESET◆	
High O ₂ Alarm Status	NORMAL	NORMAL ALARM◆ RESET◆	
High Enclosure Temperature Alarm Status	NORMAL	NORMAL ALARM◆ RESET◆	
High Internal Oxygen Concentration Alarm Status	NORMAL	NORMAL ALARM◆ RESET◆	
Low PEEP Alarm Status	NORMAL	NORMAL ALARM◆ RESET◆	

Table A-6: Alarm Status Report (Sheet 2 of 3)

RS-232 Communications Protocol

Alarm Status Report (Continued)			
Description	Example	Range	Comments
Low EPAP Alarm Status	NORMAL	NORMAL ALARM◆ RESET◆	
High Leak Alarm Status	NORMAL	NORMAL ALARM◆ RESET◆	
Stop Code	0x03	N/A	ASCII End Transmission Character (ETX)

Table A-6: Alarm Status Report (Sheet 3 of 3)

Unrecognized Commands

If an unrecognized command is received, the ventilator will respond by transmitting the information shown in Table A-7: "Unrecognized Commands".

Unrecognized Commands		
Description	Example	Comments
The unrecognized command response: ?ERROR	?ERROR	
Time of request	13:45◆	24 hour clock, hh:mm◆
Up to the first five characters received set off in brackets	[VRPY]	Example for VRPT being sent as VRPY. Non-printable characters are returned as ^.

Table A-7: Unrecognized Commands

Appendix B. Customer Service & Warranty

Customer Service

For further information or assistance in operating the Respironics V200, contact Respironics Customer Service:

Within the United States: 800-345-6443
Outside the United States: 724-387-4000

Fax: 724-387-5012

email: service@respironics.com

Warranty

Two Year Warranty

Respironics warrants the Respironics V200 to be free from defects in material and workmanship for a period of two years from the date of purchase, provided that the unit is operated under conditions of normal use as described in this Operator's Manual.

At its discretion, Respironics will make replacements, repairs, or issue credits for equipment or parts that are found to be defective.

Exclusions

This warranty does not apply to any unit or individual parts which have been repaired or altered in any way that, in Respironics' judgement, affect its ability or reliability, or which has been subjected to misuse, negligence, abuse, or accident.

Unauthorized service and/or failure to perform periodic maintenance may void this warranty.

This warranty does not cover damage that may occur in shipment.

Warranty Limits

This warranty takes precedence over all other warranties, expressed or implied. This warranty also takes precedence over all other obligations or liabilities on the part of Respironics including, but not limited to, contingent or consequential damages, such as costs of repairing or replacing other property which may be damaged as a direct result of Respironics V200 operation.

This warranty, and the rights and obligations described herein, is construed under and governed by the laws of the State of California, U.S.A.

Customer Service & Warranty

Options and Accessories

Warranties are available for various options and accessories. See the specific option or accessory in Chapter 13 for complete warranty information.

Appendix C. Alarm Testing Procedure

The following procedure is available if the operator wants to test the operation of the following alarms. We recommend following “Preoperational Procedure” on page 8-32 before performing the Alarm Testing procedure. It is assumed that the preoperational procedure has been run before the Alarm Testing Procedure is followed.

Setup

1. Connect O₂ supply to the Respirationics V200 Ventilator.
2. Connect optional O₂ sensor.
3. Run EST.
4. Attach the test lung to the patient wye. (Use the test lung provided with your system.)
5. Use the following settings:
 - Mode VCV-A/C
 - Tidal Vol: 400ml
 - High Pressure (HIP): 50cmH₂O (hPa)
(or higher if required by the test lung)
 - Rate: 10 Bpm
 - Low Insp Press: 3 cmH₂O (hPa)
 - Peak Flow 40 Lpm
 - PEEP: 4 cmH₂O (hPa)
 - Low PEEP: 2 cmH₂O (hPa)
 - Low Vt Mand: 0 mL
 - PSV: 0 cmH₂O (hPa)
 - Low Vt Spont: 0 Lpm
 - I-Trigger: 2 cmH₂O (hPa)
 - High Rate: 150 Bpm
 - O₂: 21%
 - Low VE: 1 L
 - Insp. Hold: 0 sec.
 - Apnea: 15 sec.
 - Apnea Rate: 20 Bpm

Alarm Testing Procedure

High Inspiratory Pressure Alarm Test

1. During inhalation squeeze the test lung for at least two breaths until the High Pressure alarm sounds.
2. Wait for one normal breath, the alarm auto resets.
3. RESET the alarm.

Low Volume Alarm Test

1. Set the Low Vt Mand alarm limit to 500 ml.
2. Wait for one breath and alarm should sound.
3. Set the Low Vt Mand to 0 ml.
4. Wait for one breath and RESET the alarm.

Low O₂ Alarm Test

(If optional O₂ sensor is installed.)

1. Turn the ventilator OFF.
2. Disconnect the O₂ sensor and its Tee from the inhalation limb of the patient circuit. (Leave the electrical connection.)
3. Connect the inspiratory bacteria filter directly to the gas outlet port and connect the inhalation limb to the filter.
4. Turn the ventilator ON.
5. Set the O₂ setting to 40%.
6. Wait at least 3-5 breaths, the alarm should sound.
7. Set the O₂ setting to 21%.
8. Wait for 3 - 5 breaths, the alarm should reset.
9. Press the RESET key to clear the alarm.
10. Turn the ventilator OFF and re-insert the O₂ sensor and Tee.
11. Turn the ventilator ON.

Power Fail Alarm Test

1. While the system is ventilating normally, pull the AC plug from the wall.
2. If the backup battery is attached, the ventilator should continue ventilating, and an alarm should sound every 60 seconds. If no backup battery is attached, the ventilator will stop operating and sound a continuous audible alarm.
3. Plug the power cord back in.

Alarm Testing Procedure

4. Alarm should reset. (If the backup battery is attached, the ventilator should return to AC power. If no battery is attached, the ventilator will resume operating.)

Apnea Alarm Test

1. Set the rate to 1 breath per minute.
2. Wait for 20 seconds.
3. The Respironics V200 should begin ventilating at a rate of 20 BPM while activating the Apnea alarm.
4. Reset the rate to 10 BPM.
5. RESET the alarm.
6. The Respironics V200 should begin ventilating normally.

Alarm Testing Procedure

(This page is intentionally blank.)

Glossary

Abbreviations

24 Hrs used to describe format for time-of-day when AM or PM does not appear

AC alternating current (power)

A/C assist/control ventilation

AM/PM used to describe format for time-of-day when AM or PM occurs

ASCII commonly accepted 8-bit binary code for characters

Assist assist/control ventilation

ATPS ambient temperature, ambient pressure, saturated (with water vapor)

Auto-PEEP end-expiratory alveolar pressure above set PEEP level

Aux auxiliary

BTPS Body temperature (98°F, ambient pressure) 100% saturated (with water vapor)

C compliance, ratio of change in volume divided by change in pressure

CL lung compliance

cmH₂O unit of pressure measurement centimeters of water

CMV controlled mechanical ventilation (same as A/C)

CPAP continuous positive airway pressure

Crs compliance of respiratory system

Cw chest wall compliance

DISS Diameter Index Safety System

E-Cycle Expiratory Cycle

End Exp end expiratory pressure

EPAP expiratory positive airway pressure

ETO ethylene oxide. Gas used for sterilization.

Glossary

f respiratory frequency

FI₂ fractional inspired oxygen

FRC functional residual capacity

f/VT rate versus tidal volume ratio; rapid shallow breathing index

HIP high inspiratory pressure

HME heat and moisture exchanger

hPa unit of pressure measurement hecto Pascals

I:E ratio inspiration:exhalation ratio

ICU intensive care unit

ISO International Standards Organization

IMV intermittent mandatory ventilation

Inop inoperational

IPAP inspiratory positive airway pressure

I-Time inspiratory time

L Liter

MAP mean airway pressure

mL milliliter, or 1/1000 L

mm millimeters

msec millisecond

M a notation for screw threads: metric

NPPV noninvasive positive pressure ventilation

NO nitric oxide

O₂ molecular oxygen

OIM operator initiated mandatory

Paw airway pressure

PCV pressure-controlled ventilation

Pe End airway pressure at end exhalation

PEEP positive end-expiratory pressure

Pi End airway pressure at the end of inhalation

PIP peak inspiratory pressure

Plateau inspiratory plateau pressure, pressure at end exhalation and no flow from or out of the ventilator

Pplat end-inspiratory plateau pressure

psi pounds per square inch; Unit of pressure measurement

psig pounds per square inch gauge (above atmospheric pressure)

PSV pressure-support ventilation

SIMV synchronous intermittent mandatory ventilation

Spont Rate spontaneous respiratory rate

Spont T spontaneous timed

Spont VE spontaneous volume exhaled

STPD standard temperature, standard pressure dry

SVO safety valve open

Tidal Vol tidal volume

Total RR total respiratory rate

Total VE total volume exhaled/minute

V volume

\dot{V} flow

VAC volts of alternating current (power)

$\dot{V}E$ expired minute ventilation

Vent ventilator

V_T tidal volume

Glossary

Definitions

Airway Pressure the pressure in the patient circuit, measured at the distal end of the exhalation filter.

Baseline as in baseline pressure. The pressure at end exhalation.

Baud serial transmission speed usually bits/second.

Bias flow a continuous flow of gas used during expiratory phase when flow triggering is active.

Bit binary digit.

Compliance a measure of stiffness for containers that hold gas (i.e. lungs, patient tubing). The volume required to increase the pressure in the container by a unit of pressure (i.e., L/cmH₂O (hPa)).

Continuous positive airway pressure (CPAP) a mode of ventilator operation that allows the patient to breath spontaneously from a continuous-flow or demand valve at an elevated airway pressure. (same as CAP)

E-Cycle The E-Cycle setting on the ventilator determines when the ventilator will transition from inspiration to expiration in PSV and NPPV modes. E-Cycle defines the percent of peak inspiratory flow that end inspiratory flow needs to drop to in order for inspiration to end.

End Expiratory Pressure (End Exp) the airway pressure measured at the end of exhalation. The display is updated at the end of each exhalation.

Expiratory phase (exhalation) the part of the ventilatory cycle from the beginning of expiratory flow to the beginning of inspiratory flow.

Flow Trigger initiation of inspiration when the patients inspiratory effort exceeds the flow sensitivity setting (threshold).

Indicator a light, usually light emitting diode (LED).

Inspiration:Exhalation Ratio (I:E ratio) a standard I:E ratio. It is displayed as XX:1 when exhalation period is larger than the inhalation period. It is displayed as 1:XX when inhalation period is larger than the exhalation period.

Inspiratory phase (inspiration) the part of the ventilatory cycle from the beginning of inspiratory flow to the beginning of expiratory flow. Any inspiratory pause (plateau) is included in the inspiratory phase.

Inspiratory time inspiratory time (expressed in seconds) is the duration of inspiration during mechanical ventilation. As inspiratory time increases, mean airway pressure increases and the I:E ratio becomes lower.

Inspiratory pause inspiratory pause is a brief pause (0.1 to 2 seconds) at end-inspiration during which pressure is held constant and flow is zero. The purpose of the pause is to improve gas distribution throughout the lungs. Same as Plateau pressure.

Intermittent Mandatory Ventilation (IMV) a mode of ventilatory support that allows spontaneous breathing in between mandatory breaths from the ventilator.

Mandatory Breath a breath whose inspiratory flow and or pressure is under the control of the ventilator.

Manual Breath a breath initiated by the operator.

Mean Airway Pressure (MAP) the average over one inspiration/exhalation cycle. The value displayed is the average of this calculation over one minute. The display is updated at the end of each exhalation.

Medical gas a gas that has been refined and purified according to specifications in the United States Pharmacopoeia (USP) intended for human use in the diagnosis or treatment of disease.

Millisecond (msec) one thousandth of a second.

Minute Ventilation (\dot{V}_E) the total amount of gas moving out of the lungs during 1 minute.

Noninvasive pertaining to a diagnostic or therapeutic technique that does not require the skin to be broken or a cavity or organ of the body to be entered. Mechanical ventilation via mask, nasal prongs, or mouthpiece.

Peak Inhalation Pressure (PIP) the greatest airway pressure during an inspiratory cycle no matter what the breath type. The pressure is measured at the exhalation valve and the new data is displayed at the beginning of exhalation.

Plateau Pressure (Plateau) the pressure measured at the end of exhalation on every breath. The display is updated at the beginning of each exhalation.

PCMCIA Card (PC Card) Acronym for Personal Computer Memory Card International Association, more commonly referred to as a PC Card. This is a data storage device with an approximate physical size of a credit card, used in conjunction with the Trending Option.

Positive End-Expiratory Pressure (PEEP) the application and maintenance of pressure above atmospheric at the airway throughout the expiratory phase of positive-pressure mechanical ventilation.

Pressure Support Ventilation (PSV) pressure-limited assisted ventilation designed to augment a spontaneously generated breath; the patient has primary control over the frequency of breathing, the inspiratory time, and the inspiratory flow.

Glossary

Pressure Sensitivity a measure of the amount of negative pressure that must be generated by a patient to trigger a mechanical ventilator into the inspiratory phase; alternatively, the mechanism used to set or control this level.

Pressure Trigger initiation of inspiration when the patients inspiratory effort exceeds the sensitivity threshold.

PVC O₂ Sensor Tee An external oxygen sensor adapter made of polyvinyl chloride (PVC). This O₂ Sensor Tee is gray in color and cannot be autoclaved or chemically disinfected.

Rapid Shallow Breathing Index (F/V_T) used to evaluate the adequacy of the patients spontaneous ventilation. It is calculated by as shown below

- $f/V_t = (\text{Spont Rate})/(\text{Spont VE})$

Resistance The pressure drop across a pneumatic device (i.e. bacteria filter, patient circuit tubing) for a unit of flow when the volume of the device remains constant, i.e., (cmH₂O (hPa))/mL/sec.

Risetime the time required for a pressure support or pressure controlled breath to reach its target pressure.

RS-232 ANSI standard for communication.

Spontaneous Respiratory Rate (Spont Rate) the average rate of the spontaneous breaths in the last eight breaths delivered by the ventilator.

Spontaneous Volume Exhaled (Spont \dot{V}_E) the exhaled volume that would come from spontaneous breaths, projected over one minute. The calculation is done by averaging the spontaneous exhaled tidal volume from the last eight breaths and projecting what that volume would be if it continued for one minute.

Tidal Volume (Tidal Vol) the volume of patient gas as measured at the exhalation flow transducer. The display shows an average unless the current breath differs substantially from the average. When there is a substantial change, the current breath is displayed. The average for tidal volume is restarted when the operator changes the tidal volume setting and the machine is delivering mandatory breaths.

Time Trigger initiation of inspiration by the ventilator according to the respiratory frequency (Rate) setting.

Total Respiratory Rate (Total RR) the total breaths taken, spontaneous breath rate + mandatory breath rate, from the last eight breaths and projecting what that rate would be if it continued for one minute.

Total Volume Exhaled (Total \dot{V}_E) the total exhaled volume that would come from all the patient's breaths, projected over one minute. The calculation is done by averaging the total exhaled tidal volume from the last eight breaths and projecting what that volume would be if it continued for one minute. This value is updated at the end of each exhalation.

Trigger normally a patient effort to begin inhalation.

Volume space occupied by matter measured in milliliters or liters.

Window either a period of time or a portion of a screen depending on the context.

Glossary

(This page is intentionally blank.)

Index

Symbols

100% O2 Key, 8-9

A

A/C, Assist Control, 7-3
AC Inlet, 5-2
ACCEPT key, 5-8, 8-2
Accept Key, 8-8
Accessories, 4-2, 13-1
Adjust Control Knob, 8-11, 12-7
Adult
 Disposable Patient Circuit, 13-2
 Patient Circuit Kit, 13-2
Adult/Pediatric Keys, 8-20
Air Inlet Filter, 5-1
Air Source Fault Alarm, 9-5
Airway Pressure, 7-4
Alarm Reset Key, 8-9
Alarm Silence, 12-9
Alarm Silence Key, 8-9
Alarm Status
 Indicators, 8-5
Alarms, 9-1
 Audible, 9-2
 Auto-Reset of, 9-3
 Descriptions, 9-5, 9-8
 High Urgency, 9-1, 9-2
 Low Urgency, 9-1, 9-2
 Medium Urgency, 9-1, 9-2
 Operator-Initiated Reset of, 9-3
 Remote, 6-2
 Reset, 9-3
 Silence, 9-2
 Visual, 9-1
Alert Messages, 9-4
Altitude, Setting, 5-5, 5-9
Analog Port, 5-2, 6-7

Apnea Alarm, 9-5
Apnea Ventilation, 7-7, 8-27
 Operation During, 7-7
 Respiratory Rate, 8-22
Apply Date, 5-8
Apply Time, 5-8
Assist Control Ventilation, 7-3
Assist Control Ventilation (A/C), 7-3
Audible Alarm Failed Alarm, 9-5
Auto-PEEP, 8-31
 Calculation, 8-31

B

Backup Battery, 4-4
 Power Status Indicators, 8-6
Bad ADC Wrap Sensor Alarm, 9-5
Bad Bat Volt Sensor Alarm, 9-5
Bad Int O2 Sensor Alarm, 9-5
Bad Int Temp Sensor Alarm, 9-5
Battery Backup On Alarm, 9-5
Baud Rate, RS-232, 6-2, A-1
Breath Indicator, 8-13
Breath Type, 12-1
 Selecting, 8-23
BTPS, G-1
Built-In Test, 11-11
Bus Activity Monitor, 11-10

C

Cautions, 2-5
Circuit Breaker
 Humidifier AC, 5-2
 Mains, 5-2
Cleaning, Ventilator Parts, 10-1
Clock, 5-7

Index

Compliance, G-1, G-4
 Circuit, 5-5, 11-5
 Compensation, 8-33, 11-1
 Tubing, 5-10
Compliance and Approvals, 12-11
Continuous Positive Airway Pressure, 7-4
CPAP, 7-4

D

Date of Manufacture, 3-3
Date Setting, 5-7
Delivered O₂, %O₂, 8-29
Diagnostic
 Codes, 11-5
 Descriptions, 11-6, 11-8
 Mode, 5-5, 11-2
Diagnostics, 11-1
Display
 Front Touch Panel, 8-11
 Patient Leak, 7-6

E

End Exhalation Pressure, 8-31
EPAP, 7-6, 8-23, 12-3, G-1
EST, 11-4
Exhalation Bacteria Filter, 13-2
Exp Valve Stuck Open Alarm, 9-5
Expiratory Bacteria Filter, 4-18
Expiratory Hold
 Calculated Values, 12-7
Expiratory Hold Key, 8-10
Expiratory Positive Airway Pressure, G-1
Extended Self Test (EST), 5-12, 11-4

F

F/Vt, 8-29
Filters
 Removal/Installation
 Bacteria, 10-4
 Cooling, 10-8
 Heated Bacteria, 4-18
 Inspiratory Bacteria, 4-16
 Internal Air Source Inlet, 10-10
 O₂ Input Filter, 10-9
Flex Arm, 4-22
Front Panel, 8-3
 Controls, 8-10
 Keys, 8-8
 Text Version, 8-3
 Touch Display, 8-11

G

Gas Supplies Lost - SVO Alarm, 9-5
Glossary, G-1

H

High Indicator, 8-5
High Inspiratory Pressure, 9-5, 12-9
 Alarm Test, C-2
High Inspiratory Pressure Alarm, 9-5
High Internal O₂ Alarm, 9-5
High Leak Rate Alarm, 9-5
High Minute Volume Alarm, 9-6
High O₂ Alarm, 9-6
High Respiratory Rate, 9-6, 12-9
High Respiratory Rate Alarm, 9-6
High Temperature Alarm, 9-6
High Urgency Alarm, 12-9
high urgency alarm, 9-1, 9-5
Humidifier
 AC Circuit Breaker, 5-2
 AC Outlet, 6-1
 Connecting, 6-3

I

I:E Ratio, 8-29
 Inspiratory Bacteria Filter, 4-17, 13-2, 13-4
 Installation, 4-16
 Removing and Replacing, 10-5
 Inspiratory Trigger (I-Trigger), 8-21
 IPAP, 7-6, 8-23, 12-3
 I-TIME, 7-2
 I-Time Too Long Alarm, 9-6

L

Labels, 12-18
 Lock
 Screen, 8-8
 Low Backup Battery Alarm, 9-6
 Low EPAP Alarm, 9-6
 Low Insp Pressure Alarm, 9-7
 Low Minute Volume Alarm, 9-7
 Low O2 Alarm, 9-7
 Low O2 Supply Alarm, 9-7
 Low PEEP Alarm, 9-7
 Low Tidal Volume Alarm, 9-7
 Low Vt Mandatory Alarm, 9-8
 Low Vt Spontaneous Alarm, 9-8

M

Mandatory Breaths, 7-3, 8-26
 Manometer, 8-13
 Manual Breath Key, 8-10
 Med/Low Indicator, 8-5
 Medium/Low Urgency Alarm, 12-9
 Modes, 8-1, 12-1
 Common to NPPV, 7-6
 Common to VCV & PCV, 7-3
 Emergency, 7-7
 Mount
 Wall, 5-4

N

Non-Invasive Positive Pressure Ventilation (NPPV), 7-6
 Non-Invasive Ventilation, 7-1, 7-6, 8-1
 Normal Indicator, 8-5, 12-9
 Notes, 2-8
 NPPV, 7-6, 8-23

Symbols

Nurse Call
 Label, 12-18
 Remote Alarm, 5-1

O

O2
 Cylinder Bracket, 13-1
 High Pressure Hose, 13-1
 Manifold, 13-1
 Sensor, 4-16, 13-3
 Sensor Kit, 13-1
 O2 Sensor Tee
 Autoclaving, 10-2
 Chemical Disinfecting, 10-2
 See also PVC O2 Sensor Tee
 O2 Valve Stuck Closed Alarm, 9-8
 Occlusion - SVO Alarm, 9-8
 On/Off
 Power, 5-4
 On/Off Switch, 5-2
 Open, 7-7
 Safety Valve, 7-7, 7-8, 9-9, 9-10
 Operating
 Conditions, 9-1
 Instructions, 8-1
 Theory, 7-1
 Options
 Communications, 13-1
 Flow-Trak, 13-1
 Graphics, 13-1
 Neonatal, 13-1

Index

- Respiratory Mechanics, 13-1
 - RS-232 Communications 2, 13-1
 - Trending, 13-1
 - Output
 - Analog label, 3-1
 - Analog port, 6-7
 - Field, A-1
 - Port, 6-1
 - Serial label, 3-2
 - Oxygen
 - Source Connection, 4-21
 - Oxygen Sensor, 13-3
- ## P
- Panel, Back
 - Connections and Controls, 5-1
 - Panel, Front
 - Display, 8-11
 - Patient Initiated Breath Triggering, 7-5
 - Patient Leak Display, 7-6
 - Pediatric
 - Patient Circuit Kit, 13-2
 - Positive End Expiratory Pressure (PEEP), 7-5
 - POST, 11-10
 - Power Cord, 5-3
 - Power On Self Test (POST), 11-10
 - Power Status Indicators, 8-6
 - Pressure Support Ventilation (PSV), 7-4
 - PVC O2 Sensor Tee
 - Cannot be autoclaved, 10-2
 - Cannot be chemically disinfected, 10-2
- ## R
- Restart, 11-11
 - Alarm, 9-8
 - Rise Time Setting, 7-5
- ## S
- Safety Valve Open, 12-9
 - Safety Valve Ventilator Inoperative, 8-5
 - Schedule for Periodic Maintenance, 10-7
 - Screen Lock Key, 8-8
 - Screen Locked, 12-9
 - Self-Test Hardware, 11-10
 - Serial Port, 5-1
 - SIMV, 7-3
 - Software Options, 13-1
 - Spont Rate, 8-29
 - Spontaneous Respiratory Rate (Spont Rate), G-6
 - Spontaneous Volume Exhaled (Spont VE), G-6
 - SST, 11-3
 - Symbols, 3-1
 - Synchronized Intermittent Mandatory Ventilation (SIMV), 7-3
- ## T
- Table Top Mounting, 4-4
 - Tidal Volume, G-6
 - Time Format, 5-7
 - Time Setting, 5-7
 - Total Rate, 8-29
 - Total VE, 8-29
 - Touch Display, 8-11
- ## U
- Using Default Altitude Alarm, 9-8
 - Using Default Compliance Alarm, 9-8
 - Using Default Settings Alarm, 9-8
- ## V
- Ventilator Inoperative, 12-9
 - Ventilator Inoperative Indicator, 8-5
- ## W
- Warnings, 2-1
 - Warranty, 13-5, B-1